

CELLULAR SHADES COLLECTION

Including Pleated Shades / Odysee™ Cellular Blinds / Custom Graphic Shades



**NEW
FABRICS**
*Verona &
Boutique*

2017

Manufacturer's Price List and Reference Guide | *Effective May 1st*



www.midwestdesignersupply.com

888-523-2611
262-524-1007 (fax)



Comfortex
WINDOW FASHIONS

Comfortex Cellular, Pleated and Prelude Shades and Cellular Blinds

Price List and Reference Guide | Effective May 1, 2017 • Updated June 29, 2017

This price list and reference guide contains product pricing, product specifications and technical information for the complete line of Comfortex Cellular, Pleated and Prelude Shades and Odysee Cellular Blinds.

Cellular, Pleated and Prelude Shades Overview

Features At A Glance	5
Key Features	6-7
Fabric Collections	8
Upgrade Options	9
Size Standards	10-12
Product Options Availability	13-14
Shade Stack Heights	15-16

Rectangular

Light Filtering: Boutique 3/4", Linen Weave 3/4" and Verona 3/4"	Price Group 1	17
Room Darkening: Boutique 3/4", Linen Weave 3/4" and Verona 3/4"	Price Group 2	18
Silk Essence 1/2" Light Filtering	Price Group 3	19
Natural Linen Flax 1/2" Sheer	Price Group 4	20
Premiere 1/2" Light Filtering	Price Group 5	21
Premiere 1/2" Blackout	Price Group 6	22
Premiere 3/4" Light Filtering	Price Group 7	23
Premiere 3/4" Blackout	Price Group 8	24
Debut 1/2" Single Light Filtering	Price Group 9	25
Debut 3/4" Light Filtering	Price Group 10	26
Debut 1/2" Double Light Filtering	Price Group 10	26
Symphony 3/8" Light Filtering and Flame Resistant	Price Group 11	27
Symphony 3/8" Blackout	Price Group 12	28
Baritone 3/4" Light Filtering	Price Group 13	29
Baritone 3/4" Blackout	Price Group 14	30
Virtuoso 1/2" Light Filtering	Price Group 15	31
Virtuoso 1/2" Blackout	Price Group 16	32
Prelude 3/4" Light Filtering	Price Group 17	33
Prelude 3/4" Blackout	Price Group 18	34
Privada Privacy Pleated	Price Group 19	35-36

Ovation Cellular Sliders

Size Standards - Ovation Cellular Slider Shades	37	
Ovation Cellular Slider Shades Light Filtering	Price Group 20	38
Prelude Ovation Cellular Slider Shades Light Filtering	Price Group 21	38
Ovation Cellular Slider Shades Room Darkening	Price Group 22	39
Prelude Ovation Cellular Slider Shades Blackout	Price Group 23	39

Specialty Shaped Shades

Starburst™ Arches and Quarter Rounds

Size Standards - Specialty Shaped Shades	41-42	
Baritone 3/4" Light Filtering, Boutique 3/4" Light Filtering, Debut 1/2" Single Light Filtering, Debut 1/2" Double Light Filtering, Debut 3/4" Light Filtering, Linen Weave 3/4" Light Filtering, Natural Linen Flax 1/2" Sheer, Premiere 1/2" Light Filtering, Premiere 3/4" Light Filtering, Silk Essence 1/2" Light Filtering, Symphony 3/8" Light Filtering and Flame Resistant, Verona 3/4" Light Filtering and Virtuoso 1/2" Light Filtering	Price Group 24	43
Prelude 3/4" Light Filtering	Price Group 25	43
Boutique 3/4" Room Darkening, Linen Weave 3/4" Room Darkening, Premiere 1/2" Blackout, Premiere 3/4" Blackout, Symphony 3/8" Blackout and Verona 3/4" Room Darkening	Price Group 26	44
Prelude 3/4" Blackout	Price Group 27	44

Sunset™ Arches

Verona 3/4" Light Filtering, Boutique 3/4" Light Filtering, Baritone 3/4" Light Filtering, Debut 1/2" Single Light Filtering, Debut 3/4" Light Filtering, Debut 1/2" Double Light Filtering, Linen Weave 3/4" Light Filtering, Premiere 1/2" Light Filtering, Premiere 3/4" Light Filtering, Silk Essence 1/2" Light Filtering, Symphony 3/8" Light Filtering and Flame Resistant and Virtuoso 1/2" Light Filtering	Price Group 28	45
Prelude 3/4" Light Filtering	Price Group 29	45
Boutique 3/4" Room Darkening, Linen Weave 3/4" Room Darkening, Premiere 1/2" Blackout, Premiere 3/4" Blackout, Symphony 3/8" Blackout and Verona 3/4" Room Darkening	Price Group 30	46
Prelude 3/4" Blackout	Price Group 31	46

Trapezoids and Octagons

Baritone 3/4" Light Filtering, Boutique 3/4" Light Filtering, Debut 1/2" Single Light Filtering, Debut 1/2" Double Light Filtering, Debut 3/4" Light Filtering, Linen Weave 3/4" Light Filtering, Premiere 1/2" Light Filtering, Premiere 3/4" Light Filtering, Silk Essence 1/2" Light Filtering, Symphony 3/8" Light Filtering and Flame Resistant, Verona 3/4" Light Filtering and Virtuoso 1/2" Light Filtering	Price Group 32	47
Prelude 3/4" Light Filtering	Price Group 33	47
Boutique 3/4" Room Darkening, Linen Weave 3/4" Room Darkening, Premiere 1/2" Blackout, Premiere 3/4" Blackout, Symphony 3/8" Blackout and Verona 3/4" Room Darkening	Price Group 34	48
Prelude 3/4" Blackout	Price Group 35	48

Soprano® Skylights and Greenhouse Shades

Size Standards - Skylight and Greenhouse Shades		49
Debut 1/2" Light Filtering, Silk Essence 1/2" Light Filtering, Symphony 3/8" Light Filtering and Flame Resistant and Virtuoso 1/2" Light Filtering	Price Group 36	50

Balcony™ Shading System

Debut 1/2" Light Filtering, Silk Essence 1/2" Light Filtering, Symphony 3/8" Light Filtering and Flame Resistant and Virtuoso 1/2" Light Filtering	Price Group 37	51
Symphony 3/8" Blackout and Virtuoso 1/2" Blackout	Price Group 38	52

Mezzo Motorized Skylight Shading System

Baritone 3/4" Light Filtering, Boutique 3/4" Light Filtering, Debut 1/2" Single Light Filtering, Debut 3/4" Light Filtering, Debut 1/2" Double Light Filtering, Linen Weave 3/4" Light Filtering, Premiere 1/2" Light Filtering, Premiere 3/4" Light Filtering, Silk Essence 1/2" Light Filtering, Symphony 3/8" Light Filtering and Flame Resistant, Verona 3/4" Light Filtering, and Virtuoso 1/2" Light Filtering	Price Group 39	53
Baritone 3/4" Blackout, Boutique 3/4" Room Darkening, Linen Weave 3/4" Room Darkening, Premiere 1/2" Blackout, Premiere 3/4" Blackout, Symphony 3/8" Blackout, Verona 3/4" Room Darkening and Virtuoso 1/2" Blackout	Price Group 40	54

Prelude Skylight Shading System

Prelude 3/4" Light Filtering	Price Group 41	55
Prelude 3/4" Blackout	Price Group 42	55

Privada Skylight Shading System

Privada Privacy Pleated	Price Group 43	56
-------------------------	-----------------------	----

French Door Décor

Size Standards - Door Decor Hardware Shades		57
---	--	----

Non-Movable

Boutique ¾" Light Filtering, Debut ½" Single Light Filtering, Linen Weave ¾" Light Filtering, Natural Linen Flax ½" Sheer, Premiere ½" Light Filtering, Silk Essence ½" Light Filtering, Symphony ¾" Light Filtering and Flame Resistant, Verona ¾" Light Filtering and Virtuoso ½" Light Filtering	Price Group 44	58
---	---------------------------------	----

Movable

Debut ½" Single Light Filtering, Natural Linen Flax ½" Sheer, Premiere ½" Light Filtering, Silk Essence ½" Light Filtering, Symphony ¾" Light Filtering and Flame Resistant and Virtuoso ½" Light Filtering	Price Group 45	59
---	---------------------------------	----

Non-Movable

Boutique ¾" Room Darkening, Linen Weave ¾" Room Darkening, Premiere ½" Blackout, Symphony ¾" Blackout, Verona ¾" Blackout and Virtuoso ½" Blackout	Price Group 46	60
--	---------------------------------	----

Movable

Premiere ½" Blackout, Symphony ¾" Blackout and Virtuoso ½" Blackout	Price Group 47	61
---	---------------------------------	----

Hardware - All fabrics except Prelude

Standard and Deluxe Cord Lock Shades	62-63
Cord Loop Hardware System	64-65
Cordless Ultra Hardware System	66-67
Cordless Lift & Lock	68-69
Simplicity Motorized Cellular Shades	70-71
Rechargeable Simplicity Motorized Cellular Shades	72-74
Simplicity Smart Controller	75
Rechargeable Powertouch Motorized Cellular Shades	76-77
Ovation Cellular Slider	78-79
Insulating SlumberShades	80-81
Starburst Arches	82
Sunset Arches	83-84
Quarter Rounds	85-86
Trapezoids and Octagons	87-88
Soprano Skylights and Greenhouse Shades	89-90
Balcony Shading System	91-92
Mezzo Motorized Skylight Shading System	93-95
Privada Privacy Pleated Skylight Shading System	96
Door Decor	97-98
Day - Night Shades	99-100

Custom Graphics

Custom Graphics	101
---------------------------	-----

Hardware - Prelude

Prelude Standard Cord Lock Shades	102-103
Prelude Cord Loop Hardware System	104-105
Prelude Cordless Ultra Hardware System	106-107
Prelude Cordless Lift & Lock	108-109
Prelude Ovation Cellular Slider	110-111
Prelude Starburst Arches	112
Prelude Sunset Arches	113-114
Prelude Quarter Rounds	115
Prelude Trapezoids and Octagons	116-117
Prelude Skylight Shading System	118
Prelude Simplicity Wand Motorized Cellular Shades	119-120

Cellular Shades General Information

Highlights Cornice Valances	121
Fabric Characteristics	121
Cut-Outs	121
Scotchgard Protection	122

Certified Fabrics	122
Symphony Flame Resistant Fabrics	122
EZ Level	122
Cleaning and Care	123
Measuring Instructions	133
Measuring Specialty Shades	133
Making the Perfect Template	134

Odysee Cellular Blinds

Key Features	125
Features At A Glance	125
Odysee Light Filtering	Price Group 48 126
Odysee Hardware	127
Operating Odysee Blinds	128
Operating Cords	128
Stack Heights	128
Odysee Vane Characteristics	128
Cordless PowerTouch Push Button Control	129
Motorized Odysee Cellular Blinds	130
Rechargeable Motorized Odysee Cellular Blinds	131
Odysee Certified Fabrics	132
Measuring Instructions for Odysee Cellular Blinds	132
Cleaning and Care of Odysee Cellular Blinds	132

Policies and Warranty





Child Safety	135
Conditions Of Sale	135
Policies	136
Custom Graphics Cellular Shades Color Warranty	136
Scotchgard™ Warranty	137
Cellular and Pleated Shades, Odysee Cellular Blinds Warranty Information	137-138
Motorized Shades Warranty	138

Cellular and Pleated Shades



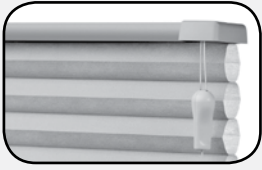

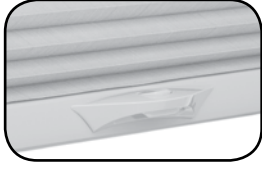

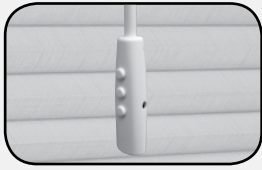

- Originally created as a solution to excessive heat loss or gain in greenhouses and solariums, Comfortex Cellular Shades are energy efficient and provide comfort in all seasons and climates.
- Durable, washable, dust resistant and light diffusing-our non-woven polyester cellular fabrics are a balance of dynamic form and life lasting function.
- Select what meets your creative desire for every room in your home knowing that all our light filtering cellular and blackout fabrics are pure white to the outside (except duotone fabrics).
- Color Coordinated components compliment the shade fabric for a cohesive look .
- Create a designer look with the Designer Oil Rubbed Bronze and Brushed Nickel Hardware on shades using standard or Deluxe Cord Lock Rail, Cord Loop and Cordless Ultra Hardware.
- In addition to superior insulation, Comfortex window shades eliminate virtually 100% of the ultraviolet light that can destroy the texture and color of your valuable home furnishings - yet our colors never fade.
- Comfortex Ovation allows select Energy Smart Double and Single Honeycomb Cellular Fabrics to be used in vertical applications where sliding window treatments are ideal: over doors, wide windows and as room dividers.
- Comfortex Cellular Shades with the Motorized Lift utilize the Simplicity System. The motors will fully operate the shades with radio frequency technology.
- Simplicity Shades can be powered by a discrete and easy to use custom rechargeable battery pack. Simplicity Shades can be operated for up to one full year on a single charge. And, you can recharge the batteries up to 500 times! Simply plug the charger into the charging port on the shade and plug into a standard household outlet to recharge overnight.
- Scotchgard™ protection exclusively from Comfortex available on Linen Weave Cellular shades. Comfortex Window Fashions provides a limited warranty for fabrics treated with 3M Scotchgard™ Protector against permanent stains for a period of one year from the date of original purchase.
- A limited lifetime warranty is our commitment to your satisfaction.

Cellular and Pleated Shade Hardware Options

	Key Features	Color Options	Hardware Size (Depth x Height)	Widths & Lengths*	More Information
Cord Lock 	<ul style="list-style-type: none"> Reliable cord lock Sleek, color coordinated rails UV resistant materials 	<ul style="list-style-type: none"> Color Coordinated Fabric Wrapped Brushed Nickel Oil Rubbed Bronze 	Standard Head Rail: 1 7/8" x 1/2" Deluxe Head Rail: 2 3/8" x 1/2"	Width: 8" to 120" Length: 8" to 120"	Page 62
Cord Loop 	<ul style="list-style-type: none"> Great for large windows Smooth & quiet operation 	<ul style="list-style-type: none"> Color Coordinated Fabric Wrapped Brushed Nickel Oil Rubbed Bronze 	2 1/4" x 1 1/2"	Width: 14" to 120" Length: 8" to 120"	Page 64
Cordless Ultra 	<ul style="list-style-type: none"> Child safe No visible cords Smooth & quiet operation Sleek clear handle on rails 	<ul style="list-style-type: none"> Color Coordinated Fabric Wrapped Brushed Nickel Oil Rubbed Bronze 	2 1/4" x 1 1/2"	Width: 18" to 120" Length: 8" to 84"	Page 66
Cordless Lift & Lock 	<ul style="list-style-type: none"> Child safe Easy push button operation Rails lock securely in place in any position Color coordinated rails and handle 	<ul style="list-style-type: none"> Color Coordinated Fabric Wrapped Oil Rubbed Bronze 	Standard Head Rail: 1 7/8" x 1/2" Deluxe Head Rail: 2 3/8" x 1/2" Bottom Rail: 1 7/8" x 1 1/8"	Width: 16" to 96" Length: 8" to 84"	Page 68
Simplicity Motorization 	<ul style="list-style-type: none"> Raise & lower shade with click of a button Great for large and hard to reach windows Remote can operate multiple shades 	<ul style="list-style-type: none"> Color Coordinated Fabric Wrapped Oil Rubbed Bronze Brushed Nickel 	2 1/4" x 1 1/2"	Width: 18" to 120" Length: 8" to 120"	Page 70
Simplicity Rechargeable Motorization 	<ul style="list-style-type: none"> Raise & lower shade with click of a button Great for large and hard to reach windows Remote can operate multiple shades 	<ul style="list-style-type: none"> Color Coordinated Fabric Wrapped Oil Rubbed Bronze Brushed Nickel 	2 1/4" x 1 1/2"	Width: 18" to 120" Length: 8" to 120"	Page 72
PowerTouch™ Rechargeable Cordless Wand 	<ul style="list-style-type: none"> Raise & lower shade with push of a button Just "Touch & Go" to operate the shade Set your favorite shade position Easy access to charging port on side of pendant 	<ul style="list-style-type: none"> Wand and pendant available in white or black 	2 1/4" x 1 1/2"	Width: 18" to 120" Length: 8" to 120"	Page 76

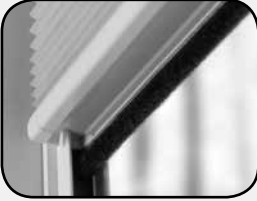
* Maximum widths and lengths listed do not take into account square foot or weight limitations. Make sure to refer to shaded areas on price groups for maximum size availability by fabric style.

Cellular and Pleated Shade Hardware Options

	Key Features	Color Options	Hardware Size (Depth x Height)	Widths & Lengths*	More Information
Ovation™ Slider 	<ul style="list-style-type: none"> Vertically oriented fabric glides across window Shade can stack left, right or center Great for sliding glass doors or room dividers 	<ul style="list-style-type: none"> White (Standard) Ivory Beige Tan Gray 	3 5/8" x 1 3/4"	Width: 12" to 168" Length: 24" to 120"	Page 78
French Door Décor 	<ul style="list-style-type: none"> Great option for narrow windows and doors Available in moveable & non-moveable rails No Pull cords 	<ul style="list-style-type: none"> Color Coordinated Fabric Wrapped Brushed Nickel Oil Rubbed Bronze 	1 7/8" x 1/2"	Width: 6" to 36" Length: 12" to 96"	Page 97
Insulating SlumberShade™ 	<ul style="list-style-type: none"> Ultimate blackout shade Tracks keep out light, cold or heat Perfect for nurseries, day sleepers 	<ul style="list-style-type: none"> Color Coordinated Fabric Wrapped Brushed Nickel Oil Rubbed Bronze Sidetracks are available in white, tan or black 	Dependant on hardware choice	Width: 9" to 96" Length: 8" to 120"	Page 80
Top Down-Bottom Up 	<ul style="list-style-type: none"> Lower shade from top: raise from bottom Great for privacy Ideal for light control Available in Cord Lock, Cord Loop and Cordless systems 	<ul style="list-style-type: none"> Color Coordinated Fabric Wrapped Oil Rubbed Bronze Brushed Nickel 	Dependant on hardware choice	Width: 18" to 120" Length: 8" to 120"	See Product Availability Page 10-12
Two on One Head Rail 	<ul style="list-style-type: none"> Operate two shades on one rail Great for larger windows Individually operating shades 	<ul style="list-style-type: none"> Color Coordinated Fabric Wrapped Oil Rubbed Bronze Brushed Nickel 	Dependent on Style See Above	Width: 16" to 144" Length: 8" to 120"	See Product Availability Page 10-12
Highlights Cornice Valance 	<ul style="list-style-type: none"> Adds height to windows Available as inside and outside mount Easy to install 	<ul style="list-style-type: none"> 100+ Envision fabrics 100s of patterns and colors 	Valance Height: 6" Returns: 1 1/2" x 6"	Varies by selected fabric Width: 12" to 216"	Page 121

* Maximum widths and lengths listed do not take into account square foot or weight limitations. Make sure to refer to shaded areas on price groups for maximum size availability by fabric style.

Make sure to consult specification charts for specific fabric styles on pages 17- 61.

Comfortex Cellular and Pleated Shade Fabric Collections

Fabric Collection	Cell Size and Structure	Opacities	Fabric Content
Baritone*	<ul style="list-style-type: none"> • ¾-Inch • Single Cell 	<ul style="list-style-type: none"> • Light Filtering • Blackout 	<ul style="list-style-type: none"> • Light Filtering: Non-Woven Polyester • Blackout: Non-Woven Polyester with foil lining • Karma-Light technology insures color on front fabric will not be distorted like traditional blackout shades.
New Boutique	<ul style="list-style-type: none"> • ¾ -Inch • Single Cell 	<ul style="list-style-type: none"> • Light Filtering • Room Darkening 	<ul style="list-style-type: none"> • Light Filtering: Non-Woven Polyester • Room Darkening: Opaque lining pressed between two layers of non-woven polyester • Karma-Light technology insures color on front fabric will not be distorted like traditional blackout shades.
Debut**	<ul style="list-style-type: none"> • ½-Inch Single Cell • ¾-Inch Single Cell • ½-Inch Double Cell 	<ul style="list-style-type: none"> • Light Filtering 	<ul style="list-style-type: none"> • Light Filtering: Non-Woven Polyester
Linen Weave	<ul style="list-style-type: none"> • ¾ -Inch • Single Cell 	<ul style="list-style-type: none"> • Light Filtering • Room Darkening 	<ul style="list-style-type: none"> • Light Filtering: Non-Woven Polyester • Karma-Light technology insures color on front fabric will not be distorted like traditional blackout shades.
Natural Linen Flax*	<ul style="list-style-type: none"> • ½-Inch • Single Cell 	<ul style="list-style-type: none"> • Semi-Sheer 	<ul style="list-style-type: none"> • Light Filtering: Non-Woven Polyester • See page 121 for fabric characteristics
Premiere***	<ul style="list-style-type: none"> • ½-Inch • ¾-Inch • Single Cell 	<ul style="list-style-type: none"> • Light Filtering • Blackout 	<ul style="list-style-type: none"> • Light Filtering: Non-Woven Polyester • Blackout: Opaque lining pressed between two layers of non-woven polyester
Silk Essence*	<ul style="list-style-type: none"> • ½-Inch • Single Cell 	<ul style="list-style-type: none"> • Light Filtering 	<ul style="list-style-type: none"> • Light Filtering: Non-Woven Polyester
Symphony	<ul style="list-style-type: none"> • ¾-Inch • Double Cell 	<ul style="list-style-type: none"> • Light Filtering • Flame Retardant • Light Filtering • Blackout 	<ul style="list-style-type: none"> • Light Filtering: Non-Woven Polyester • Blackout: Non-Woven Polyester with foil lining
New Verona	<ul style="list-style-type: none"> • ¾ Inch • Single Cell 	<ul style="list-style-type: none"> • Light Filtering • Room Darkening 	<ul style="list-style-type: none"> • Light Filtering: Non-Woven Polyester • Room Darkening: Opaque lining pressed between two layers of non-woven polyester
Virtuoso*	<ul style="list-style-type: none"> • ½-Inch • Single Cell 	<ul style="list-style-type: none"> • Light Filtering • Blackout 	<ul style="list-style-type: none"> • Light Filtering: Non-Woven Polyester • Blackout: Non-Woven Polyester with foil lining
Privada*	<ul style="list-style-type: none"> • 1 ¾-inch 	<ul style="list-style-type: none"> • Light Filtering 	<ul style="list-style-type: none"> • Light Filtering: Non-Woven Polyester

* Not sampled in 2017 sample book ** Debut Light Filtering fabrics include solid colors, Homespun, Country Woven, Florance, Strata, Angel Hair, Blossom, Strie and Terrazzo. *** Premiere fabrics include the following prints: Spheres and Tuscan Scroll. Premiere Blackout fabrics include the following prints: Homespun, Country Woven, Florance, Strata, Angel Hair and Blossom.

Cellular Shade Hardware Upgrade Options

LIFT SYSTEM	UPGRADES	ADD
Cord Lock	Top Down-Bottom Up	\$64
Cordless Lift & Lock	Bottom Up	No extra charge
	Top Down-Bottom Up	\$83
Cordless Ultra	Bottom Up	\$83
	Top Down-Bottom Up	\$166
Cord Loop	Bottom Up	\$83
	Top Down-Bottom Up	\$166

DESIGNER UPGRADE OPTIONS	UPGRADES	ADD
Add to Any Lift System Upgrade (Chart to the left)	Metallic Hardware	\$22
	Fabric Wrapped Hardware	\$22
	Scotchgard Stain Protection	\$35
	Highlights Valance See Page 121 For More Information	
Light Blocking Sidetrack System	Insulating SlumberShades See Page 80 For More Information	\$134

ADDITIONAL OPTIONS	UPGRADES	ADD
Add to Any Upgrade Above	Two-On-One Head Rail	\$50 Add to Cord Lock Shade and add lift system upgrade
	Cut Outs	\$52 Per side
	Day-Night	Price each separate shade then add together
Other	Soprano - Two Moving Rails	\$129
	Ovation Center Stack	\$84
Accessories	6 Foot Expandable Pole	\$37
	12 Foot Expandable Pole	\$46

Cellular Shade **Motorized** Hardware Upgrade Options

MOTORIZED	UPGRADES	ADD	
PowerTouch Rechargeable Motorization System	Rechargeable Integrated Battery Pack	\$110	For More Information Page 76
	Plug-In Charger for Rechargeable Li-Ion	\$27	
Simplicity Motorization System	Motor and Battery Wand	\$334	For More Information Page 70
	Simplicity 5 Channel Remote	\$40	
	Simplicity 6 Channel Remote	\$65	
	48" Extension Wire	\$18	
	DC Power Supply/Transformer	\$63	
Simplicity Rechargeable Motorization System	Motor with Integrated Li-ion Battery	\$334	For More Information Page 72
	Simplicity 5 Channel Remote	\$40	
	Simplicity 6 Channel Remote	\$65	
	Plug-In Charger for Rechargeable Li-Ion	\$27	
Simplicity Smart Controller System	NEO Controller	\$330	For More Information Page 75
	NEO Application for Mobile Devices	FREE	

SIMPLICITY MOTORIZATION PRICING EXAMPLE:

Natural Linen Flax	
Light Filtering 42" x 60" Shade:	\$350.00
Simplicity Motor Surcharge:	\$334.00
Simplicity Remote Control:	\$40.00
Total List Price:	\$724.00

SIMPLICITY RECHARGEABLE MOTORIZATION PRICING EXAMPLE:

Linen Weave Light Filtering 42" x 60" Shade:	\$350.00
Simplicity Rechargeable Surcharge:	\$334.00
Plug-In Charger for Battery (required):	\$27.00
Simplicity Remote Control:	\$40.00
Total List Price:	\$751.00

Size Standards Comfortex Cellular and Pleated Shade Fabric Collections

Cellular Shade Collection

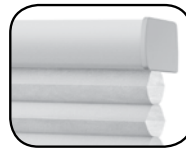
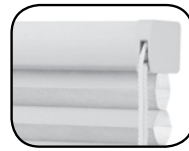
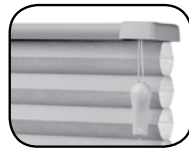

	Minimum	Cord Lock		Cord Loop		Cordless Ultra		Cordless Lift & Lock	
		Bottom Up	Top Down Bottom Up	Bottom Up	Top Down Bottom Up	Bottom Up	Top Down Bottom Up	Bottom Up	Top Down Bottom Up
		ALL FABRICS (except 3/4" Prelude)	Minimum Width	8"	12"	14"	22"	15" OB or 15 3/8" IB	18" OB or 18 3/8" IB
	Min. Length	8"	8"	8"	8"	8"	8"	8"	8"
Prelude 3/4"	Min. Width	8"	10"	18"	24"	16"	16"	12"	12"
	Min. Length	12"	12"	12"	12"	12"	12"	12"	12"

Light Filtering	Price Group	Page		Cord Lock		Cord Loop		Cordless Ultra		Cordless Lift & Lock	
				Bottom Up	Top Down Bottom Up	Bottom Up	Top Down Bottom Up	Bottom Up	Top Down Bottom Up	Bottom Up	Top Down Bottom Up
				Baritone 3/4"	13	29	Maximum Width & Length				
NEW Boutique 3/4"	1	17	Refer to shaded area in price grids for max size (sq ft) by fabric style	108" width* 120" length	96" width 96" length	108" width 120" length	108" width 120" length	108" width* 84" length	96" width 84" length	96" width 84" length	96" width 84" length
Debut	9 & 10	25									
Premiere	5	21									
Linen Weave 3/4"	1	17									
Natural Linen Flax	4	20									
Silk Essence 1/2"	3	19									
Symphony 3/8"	11	27									
NEW Verona 3/4"	1	17									
Virtuoso 1/2"	15	31									
Prelude 3/4"	17	33	Maximum Width & Length - Sq Ft.	120" width 120" length 50 sq ft	96" width 96" length 50 sq ft	120" width 120" length 100 sq ft	120" width 120" length 100 sq ft	120" width 84" length 70 sq ft	96" width 84" length 56 sq ft	84" width 84" length 49 sq ft	84" width 84" length 49 sq ft

Room Darkening & Blackout	Price Group	Page		Cord Lock		Cord Loop		Cordless Ultra		Cordless Lift & Lock								
				Bottom Up	Top Down Bottom Up	Bottom Up	Top Down Bottom Up	Bottom Up	Top Down Bottom Up	Bottom Up	Top Down Bottom Up							
				Baritone 3/4"	14	30	Maximum Width & Length											
NEW Boutique 3/4"	2	18	Refer to shaded area in price grids for max size (sq ft) by fabric style	108" width* 120" length	84" width 96" length	108" width* 120" length	108" width* 120" length	108" width* 84" length	96" width* 84" length	96" width 84" length	96" width 84" length							
Linen Weave 3/4"	2	18																
Premiere	6	22																
NEW Verona 3/4"	2	18																
Virtuoso 1/2"	16	32																
Symphony 3/8"	12	28										120" width 120" length	84" width 96" length	120" width 120" length	120" width 120" length	Not Available	84" width 84" length	84" width 84" length
Prelude 3/4"***	18	34										Maximum Width & Length - Sq Ft.	120" width 120" length 50 sq ft	96" width 96" length 50 sq ft	120" width 120" length 100 sq ft	120" width 120" length 100 sq ft	120" width 84" length 70 sq ft	96" width 84" length 56 sq ft

Privada Pleated	Price Group	Page		Cord Lock		Cord Loop		Cordless Ultra		Cordless Lift & Lock	
				Bottom Up	Top Down Bottom Up	Bottom Up	Top Down Bottom Up	Bottom Up	Top Down Bottom Up	Bottom Up	Top Down Bottom Up
				Min. Width	8"	12"	18"	NA	18" OB or 18 3/8" IB	18" OB or 18 3/8" IB	NA
Min. Length	8"	8"	8"	NA	8"	8"	NA	NA			
Max. Width	96"	96"	96"	NA	96"	96"	NA	NA			
Max. Length	120"	96"	120"	NA	84"	84"	NA	NA			

Stacking Heights Information On Page More Information On Page	Cord Lock		Cord Loop		Cordless Ultra		Cordless Lift & Lock	
	Bottom Up	Top Down Bottom Up	Bottom Up	Top Down Bottom Up	Bottom Up	Top Down Bottom Up	Bottom Up	Top Down Bottom Up
		Page 15-16	Page 15-16	Page 15-16	Page 62	Page 15-16	Page 15-16	Page 15-16

Please Note: For any shades under 12" width, the maximum height is 80".

* Baritone and Virtuoso maximum width is 120"

**Maximum width for sidemount refer to hardware pages.

120" width, 120" length
 120" width, 84" length

Size Standards Comfortex Cellular and Pleated Shade Fabric Collections



	Minimum	Motorization		Two-On-One Head Rail		
		Simplicity	Simplicity Rechargeable	PowerTouch Rechargeable	Cord Lock	Cord Loop
ALL FABRICS (except 3/4" Prelude)	Minimum Width	18"		18"	16"	36"
	Min. Length	8"		8"	8"	8"
Prelude 3/4"	Min. Width	18"		-	16"	36"
	Min. Length	12"		-	12"	12"

Light Filtering	Price Group	Page		Motorization		Two-On-One Head Rail	
				Simplicity	Simplicity Rechargeable	PowerTouch Rechargeable	Cord Lock
Baritone 3/4"	13	29	Maximum Width & Length	96" width 120" length	96" width 120" length	144" width 120" length	144" width 120" length
NEW Boutique 3/4"	1	17					
Debut	9 & 10	25	Refer to shaded area in price grids for max size (sq ft) by fabric style	96" width 120" length	96" width 120" length	144" width 120" length	144" width 120" length
Premiere	5	21					
Linen Weave 3/4"	1	17					
Natural Linen Flax	4	20					
Silk Essence 1/2"	3	19					
Symphony 3/8"	11	27					
NEW Verona 3/4"	1	17					
Virtuoso 1/2"	15	31					
Prelude 3/4"	17	33	Maximum Width & Length - Sq Ft.	96" width 120" length 50 sq ft	NA	120" width 120" length 50 sq ft	120" width 120" length 50 sq ft

Room Darkening & Blackout	Price Group	Page		Motorization		Two-On-One Head Rail	
				Simplicity	Simplicity Rechargeable	PowerTouch Rechargeable	Bottom Up
Baritone 3/4"	14	30	Maximum Width & Length	96" width 120" length	96" width 120" length	144" width 120" length	144" width 120" length
NEW Boutique 3/4"	2	18					
Linen Weave 3/4"	2	18	Refer to shaded area in price grids for max size (sq ft) by fabric style	96" width 120" length	96" width 120" length	144" width 120" length	144" width 120" length
Premiere	6	22					
NEW Verona 3/4"	2	18					
Virtuoso 1/2"	16	32					
Symphony 3/8"	12	28					
Prelude 3/4"	18	34	Maximum Width & Length - Sq Ft.	96" width 120" length 50 sq ft	NA	120" width 120" length 50sq ft	120" width 120" length 50 sq ft

Privada Pleated	Price Group	Page		Motorization		Two-On-One Head Rail		
				Simplicity	Simplicity Rechargeable	PowerTouch Rechargeable	Bottom Up	Top Down Bottom Up
	19	35	Min. Width	18"		NA	16"	36"
			Min. Length	8"		NA	8"	8"
			Max. Width	96"		NA	144"	144"
			Max. Length	120"		NA	120"	120"

Stacking Heights Information On Page More Information On Page	Motorization		Two-On-One Head Rail	
	Simplicity	Simplicity Rechargeable	PowerTouch Rechargeable	Bottom Up Top Down Bottom Up
	Page 15-16 Page 70		Page 15-16 Page 76	Page 15-16 Page 13

Please Note: For any shades under 12" width, the maximum height is 80". * Maximum widths and lengths listed do not take into account square foot or weight limitations. Make sure to refer to shaded areas on price groups for maximum size availability by fabric style.

Comfortex Cellular and Pleated Shade Fabric Collections Size Standards

Cellular Shade Collection

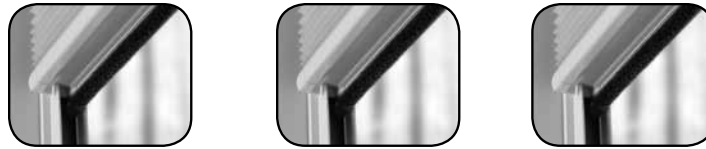

		SlumberShade Cord Lock		SlumberShade Cord Loop		SlumberShade Cordless	
Minimum		Bottom Up	Top Down Bottom Up	Bottom Up	Top Down Bottom Up	Bottom Up	Top Down Bottom Up
ALL FABRICS	Minimum Width	9"	13"	15"	25"	16" IB	19"
	Min. Length	8"	8"	8"	8"	8"	8"

			SlumberShade Cord Lock		SlumberShade Cord Loop		SlumberShade Cordless	
Light Filtering	Price Group	Page	Bottom Up	Top Down Bottom Up	Bottom Up	Top Down Bottom Up	Bottom Up	Top Down Bottom Up
Baritone 3/4"	1	17	Maximum Width & Length					
Debut	9	25						
Linen Weave	1	17	Refer to shaded area in price grids for max size (sq ft) by fabric style		96" width 120" length	96" width 96" length	96" width 120" length	96" width 120" length
Premiere	5	21						
Silk Essence 1/2"	3	19						
Symphony 3/8"	11	27						
Verona	1	17						
Virtuoso 1/2"	15	31						

			SlumberShade Cord Lock		SlumberShade Cord Loop		SlumberShade Cordless	
Room Darkening & Blackout	Price Group	Page	Bottom Up	Top Down Bottom Up	Bottom Up	Top Down Bottom Up	Bottom Up	Top Down Bottom Up
Baritone 3/4"	14	30	Maximum Width & Length					
Debut	10	26						
Linen Weave	2	18	Refer to shaded area in price grids for max size (sq ft) by fabric style		96" width 120" length	84" width 96" length	96" width 120" length	96" width 120" length
Premiere	6	22						
Symphony 3/8"	12	28						
Verona	2	18						
Virtuoso 1/2"	16	32						
								Symphony Blackout not available as cordless

			SlumberShade Cord Lock		SlumberShade Cord Loop		SlumberShade Cordless	
			Bottom Up	Top Down Bottom Up	Bottom Up	Top Down Bottom Up	Bottom Up	Top Down Bottom Up
Stacking Heights Information On Page More Information On Page			Page 15-16 Page 80		Page 15-16 Page 80		Page 15-16 Page 80	

Please Note: For any shades under 12" width, the maximum height is 80".

Product Options Availability

Use this table to ensure your coordinating options and unique shapes are consistent with your product selections.

STANDARD CORD LOCK	Verona	Boutique	Premiere Light Filtering	Premiere Blackout	Natural Linen Flax	Linen Weave LF & RD	Silk Essence	Symphony Light Filtering	Symphony Blackout
Standard Cord Lock	•	•	•	•	•	•	•	•	•
Top Down-Bottom Up	•	•	•	•	•	•	•	•	•
Two-On-One Head Rail	•	•	•	•	•	•	•	•	•
Two-On-One Head Rail with Splicer	•	•	•	•	•	•	•	•	•
Day-Night	•	•	•	•	•	•	•	•	•

CORD LOOP	Verona	Boutique	Premiere Light Filtering	Premiere Blackout	Natural Linen Flax	Linen Weave LF & RD	Silk Essence	Symphony Light Filtering	Symphony Blackout
Cord Loop	•	•	•	•	•	•	•	•	•
Cord Loop Top Down-Bottom Up	•	•	•	•	•	•	•	•	•
Cord Loop Two-On-One Head Rail	•	•	•	•	•	•	•	•	•

CORDLESS ULTRA	Verona	Boutique	Premiere Light Filtering	Premiere Blackout	Natural Linen Flax	Linen Weave LF & RD	Silk Essence	Symphony Light Filtering	Symphony Blackout
Cordless Ultra	•	•	•	•	•	•	•	•	-
Cordless Ultra Top Down-Bottom Up	•	•	•	•	•	•	•	•	-

CORDLESS LIFT & LOCK	Verona	Boutique	Premiere Light Filtering	Premiere Blackout	Natural Linen Flax	Linen Weave LF & RD	Silk Essence	Symphony Light Filtering	Symphony Blackout
Cordless Lift & Lock	•	•	•	•	•	•	•	•	•
Cordless Lift & Lock Top Down-Bottom Up	•	•	•	•	•	•	•	•	•

MOTORIZATION	Verona	Boutique	Premiere Light Filtering	Premiere Blackout	Natural Linen Flax	Linen Weave LF & RD	Silk Essence	Symphony Light Filtering	Symphony Blackout
Simplicity Motorization	•	•	•	•	•	•	•	•	•
Simplicity Rechargeable Motorization	•	•	•	•	•	•	•	•	•
PowerTouch™ Rechargeable	•	•	•	•	•	•	•	•	•

INSULATING SLUMBERSHADES	Verona	Boutique	Premiere Light Filtering	Premiere Blackout	Natural Linen Flax	Linen Weave LF & RD	Silk Essence	Symphony Light Filtering	Symphony Blackout
Cord Lock	•	-	•	•	-	•	•	•	•
Cord Lock Top Down-Bottom Up	•	-	•	•	-	•	•	•	•
Cordless Ultra	•	-	•	•	-	•	•	•	-
Cordless Ultra Top Down-Bottom Up	•	-	•	•	-	•	•	•	-
Cord Loop	•	-	•	•	-	•	•	•	•
Cord Loop Top Down-Bottom Up	•	-	•	•	-	•	•	•	•

SKYLIGHTS AND SPECIALTY SHAPES	Verona	Boutique	Premiere Light Filtering	Premiere Blackout	Natural Linen Flax	Linen Weave LF & RD	Silk Essence	Symphony Light Filtering	Symphony Blackout
Balcony Shading System	-	-	-	-	-	-	•	•	•
French Door Decor	•	•	•	•	•	•	•	•	•
Mezzo Motorized Skylights	•	•	•	•	-	•	•	•	•
Octagon	•	•	•	•	-	•	•	•	•
Ovation Cellular Slider	•	•	•++	•++	-	•	•	•	-
Quarter Round - Moveable	•	•	•	•	-	•	•	•	•
Quarter Round - Non-Movable	•	•	•	•	-	•	•	•	•
Privada Skylight Shading System	-	-	-	-	-	-	-	-	-
Soprano Skylights and Greenhouses	-	-	-	-	-	-	•	•	-
Starburst Arch - Movable	•	•	•	•	-	•	•	•	•
Starburst Arch - Non-Movable	•	•	•	•	•	•	•	•	•
Sunset Arch - Moveable	•*	•*	•	•	-	•*	•	•	-
Trapezoid	•	•	•	•	-	•	•	•	•

* Light Filtering Fabric Only
+ Light filtering perfect half circles only

++ 3/4" Premiere fabrics only

Product Options Availability

Use this table to ensure your coordinating options and unique shapes are consistent with your product selections.

STANDARD CORD LOCK	Debut ½" Light Filtering	Debut ¾" Light Filtering	Debut Double Cell Light Filtering	Virtuoso Light Filtering	Virtuoso Blackout	Baritone Light Filtering	Baritone Blackout	Privada Light Filtering
Standard Cord Lock	•	•	•	•	•	•	•	•
Top Down-Bottom Up	•	•	•	•	•	•	•	•
Two-On-One Head Rail	•	•	•	•	•	•	•	•
Two-On-One Head Rail with Splicer	•	•	•	•	•	•	•	•
Day-Night	•	•	•	•	•	•	•	-

CORD LOOP	Debut ½" Light Filtering	Debut ¾" Light Filtering	Debut Double Cell Light Filtering	Virtuoso Light Filtering	Virtuoso Blackout	Baritone Light Filtering	Baritone Blackout	Privada Light Filtering
Cord Loop	•	•	•	•	•	•	•	•
Cord Loop Top Down-Bottom Up	•	•	•	•	•	•	•	-
Cord Loop Two-On-One Head Rail	•	•	•	•	•	•	•	•

CORDLESS ULTRA	Debut ½" Light Filtering	Debut ¾" Light Filtering	Debut Double Cell Light Filtering	Virtuoso Light Filtering	Virtuoso Blackout	Baritone Light Filtering	Baritone Blackout	Privada Light Filtering
Cordless Ultra	•	•	•	•	•	•	•	•
Cordless Ultra Top Down-Bottom Up	•	•	•	•	•	•	•	•

CORDLESS LIFT & LOCK	Debut ½" Light Filtering	Debut ¾" Light Filtering	Debut Double Cell Light Filtering	Virtuoso Light Filtering	Virtuoso Blackout	Baritone Light Filtering	Baritone Blackout	Privada Light Filtering
Cordless Lift & Lock	•	•	•	•	•	•	•	-
Cordless Lift & Lock Top Down-Bottom Up	•	•	•	•	•	•	•	-

MOTORIZATION	Debut ½" Light Filtering	Debut ¾" Light Filtering	Debut Double Cell Light Filtering	Virtuoso Light Filtering	Virtuoso Blackout	Baritone Light Filtering	Baritone Blackout	Privada Light Filtering
Simplicity Motorization	•	•	•	•	•	•	•	•
Simplicity Rechargeable Motorization	•	•	•	•	•	•	•	-
PowerTouch™ Rechargeable	•	•	•	•	•	•	•	-

INSULATING SLUMBERSHADES	Debut ½" Light Filtering	Debut ¾" Light Filtering	Debut Double Cell Light Filtering	Virtuoso Light Filtering	Virtuoso Blackout	Baritone Light Filtering	Baritone Blackout	Privada Light Filtering
Cord Lock	•	•	•	•	•	•	•	-
Cord Lock Top Down-Bottom Up	•	•	•	•	•	•	•	-
Cordless Ultra	•	•	•	•	•	•	•	-
Cordless Ultra Top Down-Bottom Up	•	•	•	•	•	•	•	-
Cord Loop	•	•	•	•	•	•	•	-
Cord Loop Top Down-Bottom Up	•	•	•	•	•	•	•	-

SKYLIGHTS AND SPECIALTY SHAPES	Debut ½" Light Filtering	Debut ¾" Light Filtering	Debut Double Cell Light Filtering	Virtuoso Light Filtering	Virtuoso Blackout	Baritone Light Filtering	Baritone Blackout	Privada Light Filtering
Balcony Shading System	•	-	-	•	•	-	-	-
French Door Decor	•	•	•	•	•	•	•	-
Mezzo Motorized Skylights	•	•	•	•	•	•	•	-
Octagon	•	•	•	•	•	•	-	-
Ovation Cellular Slider	•	•	•	•	-	•	•	-
Quarter Round - Moveable	•	•	•	•	-	•	-	-
Quarter Round - Non-Movable	•	•	•	•	-	•	-	-
Privada Skylight Shading System	-	-	-	-	-	-	-	•
Soprano Skylights and Greenhouses	•	-	-	•	-	-	-	-
Starburst Arch - Movable	•	•	•	•	-	•	-	-
Starburst Arch - Non-Movable	•	•	•	•	-	•+	-	-
Sunset Arch - Moveable	•	•	•	•	•	•	•	-
Trapezoid	•	•	•	-	-	•	-	-

* Light Filtering Fabric Only
+ Light filtering perfect half circles only

** 1/2" Premiere fabrics only
++ 3/4" Premiere fabrics only

Shade Stack Heights

Measurements are in inches. Shade stacking heights applicable when the shade is in the fully raised position.

RECTANGULAR CORD LOCK - Includes head and bottom rails	48"	72"	84"	96"	108"	120"
Verona	2"	2 ³ / ₈ "	2 ⁵ / ₈ "	2 ⁷ / ₈ "	3 ¹ / ₈ "	3 ³ / ₈ "
Boutique	2"	2 ³ / ₈ "	2 ⁵ / ₈ "	2 ⁷ / ₈ "	3 ¹ / ₈ "	3 ³ / ₈ "
Baritone (all)	1 ¹ / ₂ "	1 ³ / ₄ "	1 ⁷ / ₈ "	2"	2 ¹ / ₈ "	2 ¹ / ₄ "
Debut ¹ / ₂ " Double Cell Light Filtering	1 ¹ / ₂ "	1 ⁵ / ₈ "	1 ³ / ₄ "	1 ⁷ / ₈ "	2	2 ¹ / ₈ "
Debut ¹ / ₂ " Single Cell Light Filtering	3 ¹ / ₄ "	2 ³ / ₄ "	3"	3 ³ / ₈ "	3 ⁵ / ₈ "	4
Debut ³ / ₄ " Single Cell Light Filtering	1 ¹ / ₂ "	1 ⁵ / ₈ "	1 ³ / ₄ "	1 ⁷ / ₈ "	2	2 ¹ / ₈ "
Linen Weave (All)	2"	2 ³ / ₈ "	2 ⁵ / ₈ "	2 ⁷ / ₈ "	3 ¹ / ₈ "	3 ³ / ₈ "
Natural Linen Flax ¹ / ₂ " Sheer Light Filtering	2 ¹ / ₄ "	2 ³ / ₄ "	3 ¹ / ₈ "	3 ³ / ₈ "	3 ⁵ / ₈ "	4
Premiere ¹ / ₂ " Single Cell Blackout	2"	2 ¹ / ₂ "	2 ⁵ / ₈ "	2 ⁷ / ₈ "	3 ¹ / ₈ "	3 ¹ / ₄ "
Premiere ¹ / ₂ " Single Cell Light Filtering	1 ⁷ / ₈ "	2 ¹ / ₄ "	2 ¹ / ₂ "	2 ⁵ / ₈ "	2 ⁷ / ₈ "	3
Premiere ³ / ₄ " Single Cell Blackout	2"	2 ³ / ₈ "	2 ⁵ / ₈ "	2 ³ / ₄ "	3	3 ¹ / ₈ "
Premiere ³ / ₄ " Single Cell Light Filtering	1 ³ / ₄ "	2 ¹ / ₈ "	2 ¹ / ₄ "	2 ³ / ₈ "	2 ¹ / ₂ "	2 ⁵ / ₈ "
Privada Light Filtering	1 ⁵ / ₈ "	1 ⁷ / ₈ "	2"	2 ¹ / ₈ "	2 ¹ / ₄ "	2 ³ / ₈ "
Silk Essence ¹ / ₂ " Single Cell Light Filtering	1 ⁷ / ₈ "	2 ¹ / ₄ "	2 ¹ / ₂ "	2 ⁵ / ₈ "	2 ⁷ / ₈ "	3
Symphony ³ / ₈ " Double Cell Blackout	2"	2 ¹ / ₂ "	2 ³ / ₄ "	3"	3 ¹ / ₄ "	3 ¹ / ₂ "
Symphony ³ / ₈ " Double Cell Light Filtering	2 ¹ / ₄ "	2 ³ / ₄ "	3"	3 ¹ / ₄ "	3 ¹ / ₂ "	3 ³ / ₄ "
Virtuoso ¹ / ₂ " Single Cell Blackout	2 ⁵ / ₈ "	3 ¹ / ₂ "	3 ⁷ / ₈ "	4 ¹ / ₄ "	4 ⁵ / ₈ "	5
Virtuoso ¹ / ₂ " Single Cell Light Filtering	2 ¹ / ₄ "	2 ³ / ₄ "	3"	3 ¹ / ₄ "	3 ¹ / ₂ "	3 ³ / ₄ "

For Top Down-Bottom Up, add ³/₈"

CORD LOOP - CORDLESS ULTRA - MOTORIZATION - Includes head and bottom rails	48"	72"	84"	96"	108"	120"
Verona	3"	3 ³ / ₈ "	3 ⁵ / ₈ "	3 ⁷ / ₈ "	4 ¹ / ₈ "	4 ³ / ₈ "
Boutique	3"	3 ³ / ₈ "	3 ⁵ / ₈ "	3 ⁷ / ₈ "	4 ¹ / ₈ "	4 ³ / ₈ "
Baritone (all)	2 ¹ / ₄ "	2 ¹ / ₂ "	2 ⁵ / ₈ "	2 ³ / ₄ "	2 ⁷ / ₈ "	3
Debut ¹ / ₂ " Double Cell Light Filtering	2 ¹ / ₂ "	2 ⁵ / ₈ "	2 ³ / ₄ "	2 ⁷ / ₈ "	3	3 ¹ / ₈ "
Debut ¹ / ₂ " Single Cell Light Filtering	3 ¹ / ₄ "	3 ³ / ₄ "	4"	4 ³ / ₈ "	4 ⁵ / ₈ "	5
Debut ³ / ₄ " Single Cell Light Filtering	2 ¹ / ₂ "	2 ⁵ / ₈ "	2 ³ / ₄ "	2 ⁷ / ₈ "	3	3 ¹ / ₈ "
Linen Weave (All)	3"	3 ³ / ₈ "	3 ⁵ / ₈ "	3 ⁷ / ₈ "	4 ¹ / ₈ "	4 ³ / ₈ "
Natural Linen Flax ¹ / ₂ " Sheer Light Filtering	3 ¹ / ₄ "	3 ³ / ₄ "	4 ¹ / ₈ "	4 ³ / ₈ "	4 ⁵ / ₈ "	5
Premiere ¹ / ₂ " Single Cell Blackout	3"	3 ¹ / ₂ "	3 ⁵ / ₈ "	3 ⁷ / ₈ "	4 ¹ / ₈ "	4 ¹ / ₄ "
Premiere ¹ / ₂ " Single Cell Light Filtering	2 ⁷ / ₈ "	3 ¹ / ₄ "	3 ¹ / ₂ "	3 ⁵ / ₈ "	3 ⁷ / ₈ "	4
Premiere ³ / ₄ " Single Cell Blackout	3"	3 ³ / ₈ "	3 ⁵ / ₈ "	3 ³ / ₄ "	4	4 ¹ / ₈ "
Premiere ³ / ₄ " Single Cell Light Filtering	2 ³ / ₄ "	3 ¹ / ₈ "	3 ¹ / ₄ "	3 ³ / ₈ "	3 ¹ / ₂ "	3 ⁵ / ₈ "
Privada Light Filtering	2 ⁵ / ₈ "	2 ⁷ / ₈ "	3"	3 ¹ / ₈ "	3 ¹ / ₄ "	3 ³ / ₈ "
Silk Essence ¹ / ₂ " Single Cell Light Filtering	2 ⁷ / ₈ "	3 ¹ / ₄ "	3 ¹ / ₂ "	3 ⁵ / ₈ "	3 ⁷ / ₈ "	4
Symphony ³ / ₈ " Double Cell Blackout	2 ⁷ / ₈ "	3 ³ / ₈ "	3 ⁵ / ₈ "	3 ⁷ / ₈ "	4 ¹ / ₂ "	4 ³ / ₄ "
Symphony ³ / ₈ " Double Cell Light Filtering	3 ¹ / ₈ "	3 ¹ / ₂ "	3 ³ / ₄ "	3 ⁷ / ₈ "	4 ¹ / ₈ "	4 ¹ / ₄ "
Virtuoso ¹ / ₂ " Single Cell Blackout	3 ¹ / ₂ "	4 ³ / ₈ "	4 ³ / ₄ "	5 ¹ / ₈ "	5 ¹ / ₂ "	5 ⁷ / ₈ "
Virtuoso ¹ / ₂ " Single Cell Light Filtering	3 ¹ / ₈ "	3 ¹ / ₂ "	3 ³ / ₄ "	3 ⁷ / ₈ "	4 ¹ / ₈ "	4 ¹ / ₄ "

For Top Down-Bottom Up, add ³/₈"

Shade Stack Heights

Measurements are in inches. Shade stacking heights applicable when the shade is in the fully raised position.

CORDLESS LIFT & LOCK - Includes head and bottom rails	48"	60"	72"	84"	108"	120"
Verona	2¾"	3⅛"	3⅝"	3⅝"	3⅞"	4⅙"
Boutique	2¾"	3⅛"	3⅝"	3⅝"	3⅞"	4⅙"
Baritone (all)	2¼"	2½"	2⅝"	2¾"	2⅞"	3"
Debut ½" Double Cell Light Filtering	2¼"	2⅜"	2½"	2⅝"	2¾"	2⅞"
Debut ½" Single Cell Light Filtering	3"	3½"	3¾"	4⅛"	4⅜"	4¾"
Debut ¾" Single Cell Light Filtering	2¼"	2⅜"	2½"	2⅝"	2¾"	2⅞"
Linen Weave (All)	2¾"	3⅛"	3⅝"	3⅝"	3⅞"	4⅙"
Natural Linen Flax ½" Sheer Light Filtering	3"	3½"	3⅞"	4⅛"	4⅜"	4¾"
Premiere ½" Single Cell Blackout	2¾"	3¼"	3⅝"	3⅝"	3⅞"	4"
Premiere ½" Single Cell Light Filtering	2⅝"	3¼"	3¼"	3⅝"	3½"	3½"
Premiere ¾" Single Cell Blackout	2¾"	3⅛"	3⅝"	3½"	3¾"	3⅞"
Premiere ¾" Single Cell Light Filtering	2¼"	2⅞"	3"	3⅛"	3⅜"	3½"
Silk Essence ½" Single Cell Light Filtering	2⅝"	3"	3¼"	3⅝"	3⅝"	3¾"
Symphony ⅜" Double Cell Blackout	2¾"	3¼"	3½"	NA	NA	NA
Symphony ⅜" Double Cell Light Filtering	3"	3½"	3¾"	4"	4¼"	4½"
Virtuoso ½" Single Cell Blackout	3⅝"	4½"	4⅝"	5"	5¼"	5¾"
Virtuoso ½" Single Cell Light Filtering	3"	3½"	3¾"	4"	4¼"	4½"

For Top Down-Bottom Up, add 1¼"

OVATION	84"	96"	108"	120"
All Fabrics	6½"	7¼"	8"	8¾"

Ovations minimum fabric stack measures 6½" regardless of the ordered width. Fabric stacking dimensions are determined by the slider's hardware, not ordered width.

NEW Boutique 3/4" Light Filtering
Linen Weave 3/4" Light Filtering
NEW Verona 3/4" Light Filtering

Price Group 1
Cord Lock
Cordless Lift & Lock

		Width In Inches														
		24	30	36	42	48	54	60	66	72	84	96	108	120	132	144
Length In Inches	36	181	204	233	260	288	313	340	364	391	450	506	561	622	678	735
	42	195	223	251	284	313	342	374	402	432	497	560	623	690	755	815
	48	207	239	273	306	340	373	405	441	474	543	613	683	757	827	896
	54	221	254	291	328	365	401	437	475	514	589	668	743	824	902	978
	60	235	272	313	350	389	431	469	512	554	634	718	803	887	973	1059
	66	247	288	333	374	417	460	503	548	592	680	773	864	957	1045	1138
	72	260	302	350	399	444	491	539	585	631	726	827	924	1024	1120	1220
	78	273	322	370	416	471	517	568	620	671	772	880	982	1088	1193	1295
	84	282	334	388	441	494	543	598	652	705	812	926	1033	1148	1257	1369
	90	296	349	405	460	518	574	629	686	748	861	976	1093	1211	1329	1446
	96	306	364	425	481	542	600	660	720	779	901	1025	1147	1274	1393	1518
	108	334	393	460	523	594	655	721	786	855	987	1123	1257	1396	1531	1666
120	356	426	499	568	646	714	785	859	929	1074	1224	1371	1519	1669	1816	

 Cord Loop Hardware is recommended on sizes within the shaded area.
 Motorized Lift Systems are not offered within the shaded area.

Widths over 108" will be built as Two-On-One Shades.

LIFT SYSTEM AND DESIGN UPGRADES		ADD
Cord Lock	Top Down-Bottom Up	\$64
Cordless Lift & Lock	Bottom Up	No Charge
	Top Down-Bottom Up	\$83
Cordless Ultra	Bottom Up	\$83
	Top Down-Bottom Up	\$166
Cord Loop	Bottom Up	\$83
	Top Down-Bottom Up	\$166
DESIGNER UPGRADE OPTIONS (Add to any Lift System Upgrade Above)		ADD
Metallic Hardware or Fabric Wrapped Hardware		\$22
Scotchgard Stain Protection		\$35
MOTORIZATION		MORE INFO
PowerTouch Rechargeable		Pg 76
Simplicity - Motor and Battery Wand		Pg 70
Simplicity Rechargeable Motorization - Motor with Integrated Battery		Pg 72
Plug-In Charger for Li-Lon Battery Pack (used for PowerTouch and Simplicity Rechargeable and is required)		Pg 76
Simplicity 5 Channel Remote		Pg 74
Simplicity 6 Channel Remote with Timer		Pg 74
Simplicity Smart Controller (NEO)		Pg 75
Motorized Pricing Examples		Pg 9
ADDITIONAL OPTIONS		ADD
Insulating SlumberShades	\$134 (Not Available with Boutique fabric)	
Two-On-One Head Rail	\$50 Add to Cord Lock Shade and add lift system upgrade	
Cut Outs	\$52 Per side	
Day-Night	Price each panel as separate shade and add together	
Highlights Cornice Valance	See Page 121 For More Information	

NEW Boutique 3/4" Room Darkening
Linen Weave 3/4" Room Darkening
NEW Verona 3/4" Room Darkening

Price Group 2
Cord Lock
Cordless Lift & Lock

		Width In Inches														
		24	30	36	42	48	54	60	66	72	84	96	108	120	132	144
Length In Inches	36	235	265	303	338	374	407	442	473	508	585	658	729	809	881	956
	42	254	290	326	369	407	445	486	523	562	646	728	810	897	982	1060
	48	269	311	355	398	442	485	527	573	616	706	797	888	984	1075	1165
	54	287	330	378	426	475	521	568	618	668	766	868	966	1071	1173	1271
	60	306	354	407	455	506	560	610	666	720	824	933	1044	1153	1265	1377
	66	321	374	433	486	542	598	654	712	770	884	1005	1123	1244	1359	1479
	72	338	393	455	519	577	638	701	761	820	944	1075	1201	1331	1456	1586
	78	355	419	481	541	612	672	738	806	872	1004	1144	1277	1414	1551	1684
	84	367	434	504	573	642	706	777	848	917	1056	1204	1343	1492	1634	1780
	90	385	454	527	598	673	746	818	892	972	1119	1269	1421	1574	1728	1880
	96	398	473	553	625	705	780	858	936	1013	1171	1333	1491	1656	1811	1973
	108	434	511	598	680	772	852	937	1022	1112	1283	1460	1634	1815	1990	2166
120	463	554	649	738	840	928	1021	1117	1208	1396	1591	1782	1975	2170	2361	

Cord Loop Hardware is recommended on sizes within the shaded area.
 Motorized Lift Systems are not offered within the shaded area.

Widths over 108" will be built as Two-On-One Shades.

LIFT SYSTEM AND DESIGN UPGRADES		ADD	
Cord Lock	Top Down-Bottom Up	\$64	
Cordless Lift & Lock	Bottom Up	No Charge	
	Top Down-Bottom Up	\$83	
Cordless Ultra	Bottom Up	\$83	
	Top Down-Bottom Up	\$166	
Cord Loop	Bottom Up	\$83	
	Top Down-Bottom Up	\$166	
DESIGNER UPGRADE OPTIONS (Add to any Lift System Upgrade Above)		ADD	
Metallic Hardware or Fabric Wrapped Hardware		\$22	
Scotchgard Stain Protection		\$35	
MOTORIZATION		MORE INFO	ADD
PowerTouch Rechargeable		Pg 76	\$110
Simplicity - Motor and Battery Wand		Pg 70	\$334
Simplicity Rechargeable Motorization - Motor with Integrated Battery		Pg 72	\$334
Plug-In Charger for Li-Ion Battery Pack (used for PowerTouch and Simplicity Rechargeable and is required)		Pg 76	\$27
Simplicity 5 Channel Remote		Pg 74	\$40
Simplicity 6 Channel Remote with Timer		Pg 74	\$65
Simplicity Smart Controller (NEO)		Pg 75	\$330
Motorized Pricing Examples		Pg 9	
ADDITIONAL OPTIONS			
Insulating SlumberShades		\$134 (Not Available with Boutique fabric)	
Two-On-One Head Rail		\$50 Add to Cord Lock Shade and add lift system upgrade	
Cut Outs		\$52 Per side	
Day-Night		Price each panel as separate shade and add together	
Highlights Cornice Valance		See Page 121 For More Information	

Silk Essence 1/2" Light Filtering
(Not in 2017 Sample Book)

Price Group 3
Cord Lock
Cordless Lift & Lock

Standard Rectangular

		Width In Inches														
		24	30	36	42	48	54	60	66	72	84	96	108	120	132	144
Length In Inches	36	171	192	220	245	272	296	321	343	369	425	478	530	587	640	693
	42	184	210	237	268	296	322	353	380	408	469	528	588	651	713	769
	48	195	226	258	289	321	352	383	416	447	513	579	644	714	780	846
	54	209	240	275	310	345	378	412	448	485	556	630	702	777	852	923
	60	222	257	296	331	367	406	443	483	523	598	678	758	838	919	1000
	66	233	272	314	353	394	434	475	517	559	642	730	815	903	986	1074
	72	245	285	331	377	419	464	509	552	595	685	780	873	966	1057	1151
	78	258	304	349	392	444	488	537	586	633	728	831	927	1027	1126	1223
	84	266	315	366	416	467	513	565	615	665	766	874	975	1084	1186	1293
	90	279	329	383	434	489	542	594	647	706	812	922	1032	1143	1255	1365
96	289	343	401	454	511	566	623	679	735	850	968	1083	1203	1315	1433	
108	315	371	434	493	560	618	681	742	807	931	1060	1186	1318	1445	1573	
120	336	402	471	537	609	674	741	811	877	1014	1155	1294	1434	1575	1714	

 Cord Loop Hardware is recommended on sizes within the shaded area.
Motorized Lift Systems are not offered within the shaded area.

Widths over 108" will be built as Two-On-One Shades.

LIFT SYSTEM AND DESIGN UPGRADES		ADD	
Cord Lock	Top Down-Bottom Up	\$64	
Cordless Lift & Lock	Bottom Up	No Charge	
	Top Down-Bottom Up	\$83	
Cordless Ultra	Bottom Up	\$83	
	Top Down-Bottom Up	\$166	
Cord Loop	Bottom Up	\$83	
	Top Down-Bottom Up	\$166	
DESIGNER UPGRADE OPTIONS (Add to any Lift System Upgrade Above)		ADD	
Metallic Hardware or Fabric Wrapped Hardware		\$22	
Scotchgard Stain Protection		\$35	
MOTORIZATION		MORE INFO	ADD
PowerTouch Rechargeable		Pg 76	\$110
Simplicity - Motor and Battery Wand		Pg 70	\$334
Simplicity Rechargeable Motorization - Motor with Integrated Battery		Pg 72	\$334
Plug-In Charger for Li-Lon Battery Pack (used for PowerTouch and Simplicity Rechargeable and is required)		Pg 76	\$27
Simplicity 5 Channel Remote		Pg 74	\$40
Simplicity 6 Channel Remote with Timer		Pg 74	\$65
Simplicity Smart Controller (NEO)		Pg 75	\$330
Motorized Pricing Examples		Pg 9	
ADDITIONAL OPTIONS			
Insulating SlumberShades	\$134 See Page 80 For More Information		
Two-On-One Head Rail	\$50 Add to Cord Lock Shade and add lift system upgrade		
Cut Outs	\$52 Per side		
Day-Night	Price each panel as separate shade and add together		
Highlights Cornice Valance	See Page 121 For More Information		

Natural Linen Flax 1/2" Sheer

(Not in 2017 Sample Book)

**Price Group 4
Cord Lock
Cordless Lift & Lock**

Standard Rectangular

		Width In Inches														
		24	30	36	42	48	54	60	66	72	84	96	108	120	132	144
Length In Inches	36	181	204	233	260	288	313	340	364	391	450	506	561	622	678	735
	42	195	223	251	284	313	342	374	402	432	497	560	623	690	755	815
	48	207	239	273	306	340	373	405	441	474	543	613	683	757	827	896
	54	221	254	291	328	365	401	437	475	514	589	668	743	824	902	978
	60	235	272	313	350	389	431	469	512	554	634	718	803	887	973	1059
	66	247	288	333	374	417	460	503	548	592	680	773	864	957	1045	1138
	72	260	302	350	399	444	491	539	585	631	726	827	924	1024	1120	1220
	78	273	322	370	416	471	517	568	620	671	772	880	982	1088	1193	1295
	84	282	334	388	441	494	543	598	652	705	812	926	1033	1148	1257	1369
	90	296	349	405	460	518	574	629	686	748	861	976	1093	1211	1329	1446
	96	306	364	425	481	542	600	660	720	779	901	1025	1147	1274	1393	1518
	108	334	393	460	523	594	655	721	786	855	987	1123	1257	1396	1531	1666
120	356	426	499	568	646	714	785	859	929	1074	1224	1371	1519	1669	1816	

Widths over 108" will be built as Two-On-One Shades.

LIFT SYSTEM AND DESIGN UPGRADES		ADD	
Cord Lock	Top Down-Bottom Up	\$64	
Cordless Lift & Lock	Bottom Up	No Charge	
	Top Down-Bottom Up	\$83	
Cordless Ultra	Bottom Up	\$83	
	Top Down-Bottom Up	\$166	
Cord Loop	Bottom Up	\$83	
	Top Down-Bottom Up	\$166	
DESIGNER UPGRADE OPTIONS (Add to any Lift System Upgrade Above)		ADD	
Metallic Hardware or Fabric Wrapped Hardware		\$22	
Scotchgard Stain Protection		\$35	
MOTORIZATION		MORE INFO	ADD
PowerTouch Rechargeable		Pg 76	\$110
Simplicity - Motor and Battery Wand		Pg 70	\$334
Simplicity Rechargeable Motorization - Motor with Integrated Battery		Pg 72	\$334
Plug-In Charger for Li-Lon Battery Pack (used for PowerTouch and Simplicity Rechargeable and is required)		Pg 76	\$27
Simplicity 5 Channel Remote		Pg 74	\$40
Simplicity 6 Channel Remote with Timer		Pg 74	\$65
Simplicity Smart Controller (NEO)		Pg 75	\$330
Motorized Pricing Examples		Pg 9	
ADDITIONAL OPTIONS			
Two-On-One Head Rail		\$50 Add to Cord Lock Shade and add lift system upgrade	
Cut Outs		\$52 Per side	
Day-Night		Price each panel as separate shade and add together	
Highlights Cornice Valance		See Page 121 For More Information	

Natural Linen Flax Cellular Fabric Characteristics

Natural Linen Flax fabrics are sheer and are created from flax fibers which allow the most amount light into the room. Interior shade cords and objects in the room may be clearly seen through the shades. Variations in the fabric weave, slubs, and texture are all enhancements that add to the beauty and character of the shade; no two shades will look exactly the same. See page 121 for photos of these characteristics.

Premiere 1/2" Light Filtering

Price Group 5
Cord Lock
Cordless Lift & Lock

Standard Rectangular

		Width In Inches														
		24	30	36	42	48	54	60	66	72	84	96	108	120	132	144
Length In Inches	36	135	151	173	193	214	233	252	270	290	334	376	416	461	503	545
	42	145	165	186	211	233	253	278	299	321	369	415	462	512	560	604
	48	153	178	203	227	252	277	301	327	351	403	455	506	561	613	665
	54	164	189	216	244	271	297	324	352	381	437	495	552	611	669	725
	60	174	202	233	260	289	319	348	380	411	470	533	596	658	722	786
	66	183	214	247	278	310	341	373	406	439	504	574	641	710	775	844
	72	193	224	260	296	329	365	400	434	468	538	613	686	759	831	905
	78	203	239	274	308	349	383	422	460	498	572	653	729	807	885	961
	84	209	248	288	327	367	403	444	483	523	602	687	766	852	932	1016
	90	219	259	301	341	384	426	467	509	555	638	724	811	898	986	1073
	96	227	270	315	357	402	445	490	534	578	668	761	851	945	1033	1126
	108	248	292	341	388	440	486	535	583	634	732	833	932	1036	1136	1236
120	264	316	370	422	479	530	582	637	689	797	908	1017	1127	1238	1347	

 Cord Loop Hardware is recommended on sizes within the shaded area.
Motorized Lift Systems are not offered within the shaded area.

Widths over 108" will be built as Two-On-One Shades.

LIFT SYSTEM AND DESIGN UPGRADES		ADD	
Cord Lock	Top Down-Bottom Up	\$64	
Cordless Lift & Lock	Bottom Up	No Charge	
	Top Down-Bottom Up	\$83	
Cordless Ultra	Bottom Up	\$83	
	Top Down-Bottom Up	\$166	
Cord Loop	Bottom Up	\$83	
	Top Down-Bottom Up	\$166	
DESIGNER UPGRADE OPTIONS (Add to any Lift System Upgrade Above)		ADD	
Metallic Hardware or Fabric Wrapped Hardware		\$22	
Scotchgard Stain Protection		\$35	
MOTORIZATION		MORE INFO	ADD
PowerTouch Rechargeable		Pg 76	\$110
Simplicity - Motor and Battery Wand		Pg 70	\$334
Simplicity Rechargeable Motorization - Motor with Integrated Battery		Pg 72	\$334
Plug-In Charger for Li-Lon Battery Pack (used for PowerTouch and Simplicity Rechargeable and is required)		Pg 76	\$27
Simplicity 5 Channel Remote		Pg 74	\$40
Simplicity 6 Channel Remote with Timer		Pg 74	\$65
Simplicity Smart Controller (NEO)		Pg 75	\$330
Motorized Pricing Examples		Pg 9	
ADDITIONAL OPTIONS			
Insulating SlumberShades		\$134 See Page 80 For More Information	
Two-On-One Head Rail		\$50 Add to Cord Lock Shade and add lift system upgrade	
Cut Outs		\$52 Per side	
Day-Night		Price each panel as separate shade and add together	
Highlights Cornice Valance		See Page 121 For More Information	
Prints & Custom Graphics		Add 20% - Includes Anna Cote, Gradients, Spheres, Tuscan Scroll and Custom Graphics	

Premiere 1/2" Blackout

Price Group 6
Cord Lock
Cordless Lift & Lock

Standard Rectangular

		Width In Inches														
		24	30	36	42	48	54	60	66	72	84	96	108	120	132	144
Length In Inches	36	176	197	225	251	279	303	328	351	377	435	489	541	600	654	709
	42	189	215	242	275	303	329	362	389	418	480	540	601	666	728	786
	48	199	232	264	296	328	361	392	426	457	524	592	658	730	797	865
	54	214	246	281	318	353	387	422	458	496	569	644	718	795	870	943
	60	227	263	303	338	376	415	453	494	535	611	693	775	856	939	1022
	66	238	279	322	362	403	444	485	528	571	656	747	834	923	1008	1098
	72	251	292	338	385	428	475	520	565	609	700	797	892	987	1081	1177
	78	264	311	357	401	454	498	549	598	648	744	849	948	1050	1151	1250
	84	272	323	375	426	478	524	578	628	680	783	894	996	1108	1212	1321
	90	285	337	392	444	500	554	608	662	722	830	942	1055	1168	1282	1395
	96	296	351	410	465	523	579	637	695	752	869	990	1107	1229	1343	1464
	108	323	380	444	505	572	632	696	758	825	952	1083	1212	1347	1477	1607
120	344	411	481	549	623	689	757	829	896	1037	1181	1323	1466	1610	1752	

 Cord Loop Hardware is recommended on sizes within the shaded area. Motorized Lift Systems are not offered within the shaded area.

Widths over 108" will be built as Two-On-One Shades.

LIFT SYSTEM AND DESIGN UPGRADES		ADD	
Cord Lock	Top Down-Bottom Up	\$64	
Cordless Lift & Lock	Bottom Up	No Charge	
	Top Down-Bottom Up	\$83	
Cordless Ultra	Bottom Up	\$83	
	Top Down-Bottom Up	\$166	
Cord Loop	Bottom Up	\$83	
	Top Down-Bottom Up	\$166	
DESIGNER UPGRADE OPTIONS (Add to any Lift System Upgrade Above)		ADD	
Metallic Hardware or Fabric Wrapped Hardware		\$22	
Scotchgard Stain Protection		\$35	
MOTORIZATION		MORE INFO	ADD
PowerTouch Rechargeable		Pg 76	\$110
Simplicity - Motor and Battery Wand		Pg 70	\$334
Simplicity Rechargeable Motorization - Motor with Integrated Battery		Pg 72	\$334
Plug-In Charger for Li-Lon Battery Pack (used for PowerTouch and Simplicity Rechargeable and is required)		Pg 76	\$27
Simplicity 5 Channel Remote		Pg 74	\$40
Simplicity 6 Channel Remote with Timer		Pg 74	\$65
Simplicity Smart Controller (NEO)		Pg 75	\$330
Motorized Pricing Examples		Pg 9	
ADDITIONAL OPTIONS			
Insulating SlumberShades	\$134 See Page 80 For More Information		
Two-On-One Head Rail	\$50 Add to Cord Lock Shade and add lift system upgrade		
Cut Outs	\$52 Per side		
Day-Night	Price each panel as separate shade and add together		
Highlights Cornice Valance	See Page 121 For More Information		
Prints & Custom Graphics	Add 20% - Includes Anna Cote, Gradients, Spheres, Tuscan Scroll, Homespun, Florence, Strata, Blossom, Country Woven and Custom Graphics		

Premiere 3/4" Light Filtering

Price Group 7
Cord Lock
Cordless Lift & Lock

Standard Rectangular

		Width In Inches														
		24	30	36	42	48	54	60	66	72	84	96	108	120	132	144
Length In Inches	36	149	167	191	213	236	257	278	297	319	368	414	458	508	554	600
	42	160	182	205	233	257	279	306	329	354	406	457	509	564	616	665
	48	169	196	224	250	278	305	332	360	387	444	501	557	618	675	732
	54	181	208	238	269	299	327	357	388	420	481	545	608	673	736	798
	60	192	223	257	286	318	351	383	418	453	517	587	656	724	795	865
	66	202	236	272	306	341	376	411	447	483	555	632	706	781	853	929
	72	213	247	286	326	362	402	440	478	515	592	675	755	835	915	996
	78	224	263	302	339	384	422	465	506	548	630	719	802	888	974	1058
	84	230	273	317	360	404	444	489	532	576	663	756	843	938	1026	1118
	90	241	285	332	376	423	469	514	560	611	702	797	893	988	1085	1181
	96	250	297	347	393	443	490	539	588	636	735	838	937	1040	1137	1239
108	273	322	376	427	484	535	589	642	698	806	917	1026	1140	1250	1360	
120	291	348	407	465	527	583	641	701	758	877	999	1119	1240	1362	1482	

 Cord Loop Hardware is recommended on sizes within the shaded area. Motorized Lift Systems are not offered within the shaded area.

Widths over 108" will be built as Two-On-One Shades.

LIFT SYSTEM AND DESIGN UPGRADES		ADD	
Cord Lock	Top Down-Bottom Up	\$64	
Cordless Lift & Lock	Bottom Up	No Charge	
	Top Down-Bottom Up	\$83	
Cordless Ultra	Bottom Up	\$83	
	Top Down-Bottom Up	\$166	
Cord Loop	Bottom Up	\$83	
	Top Down-Bottom Up	\$166	
DESIGNER UPGRADE OPTIONS (Add to any Lift System Upgrade Above)		ADD	
Metallic Hardware or Fabric Wrapped Hardware		\$22	
Scotchgard Stain Protection		\$35	
MOTORIZATION		MORE INFO	ADD
PowerTouch Rechargeable		Pg 76	\$110
Simplicity - Motor and Battery Wand		Pg 70	\$334
Simplicity Rechargeable Motorization - Motor with Integrated Battery		Pg 72	\$334
Plug-In Charger for Li-Lon Battery Pack (used for PowerTouch and Simplicity Rechargeable and is required)		Pg 76	\$27
Simplicity 5 Channel Remote		Pg 74	\$40
Simplicity 6 Channel Remote with Timer		Pg 74	\$65
Simplicity Smart Controller (NEO)		Pg 75	\$330
Motorized Pricing Examples		Pg 9	
ADDITIONAL OPTIONS			
Insulating SlumberShades		\$134 See Page 80 For More Information	
Two-On-One Head Rail		\$50 Add to Cord Lock Shade and add lift system upgrade	
Cut Outs		\$52 Per side	
Day-Night		Price each panel as separate shade and add together	
Highlights Cornice Valance		See Page 121 For More Information	
Prints & Custom Graphics		Add 20% - Includes Anna Cote, Gradients, Spheres, Tuscan Scroll and Custom Graphics	

Premiere 3/4" Blackout

Price Group 8
Cord Lock
Cordless Lift & Lock

Standard Rectangular

		Width In Inches														
		24	30	36	42	48	54	60	66	72	84	96	108	120	132	144
Length In Inches	36	194	218	249	277	307	335	362	387	415	479	539	596	661	721	780
	42	208	237	267	303	335	363	398	428	461	528	595	662	734	801	865
	48	220	255	292	325	362	397	432	468	504	578	652	725	804	878	952
	54	236	271	310	350	389	426	465	505	546	626	709	791	875	957	1038
	60	250	290	335	372	414	457	498	544	589	673	764	853	942	1034	1125
	66	263	307	354	398	444	489	535	582	628	722	822	918	1016	1109	1208
	72	277	322	372	424	471	523	572	622	670	770	878	982	1086	1190	1295
	78	292	342	393	441	500	549	605	658	713	819	935	1043	1155	1267	1376
	84	299	355	413	468	526	578	636	692	749	862	983	1096	1220	1334	1454
	90	314	371	432	489	550	610	669	728	795	913	1037	1161	1285	1411	1536
	96	325	387	452	511	576	637	701	765	827	956	1090	1219	1352	1479	1611
	108	355	419	489	556	630	696	766	835	908	1048	1193	1334	1482	1625	1768
120	379	453	530	605	686	758	834	912	986	1141	1299	1455	1612	1771	1927	

 Cord Loop Hardware is recommended on sizes within the shaded area. Motorized Lift Systems are not offered within the shaded area.

Widths over 108" will be built as Two-On-One Shades.

LIFT SYSTEM AND DESIGN UPGRADES			ADD
Cord Lock	Top Down-Bottom Up		\$64
Cordless Lift & Lock	Bottom Up		No Charge
	Top Down-Bottom Up		\$83
Cordless Ultra	Bottom Up		\$83
	Top Down-Bottom Up		\$166
Cord Loop	Bottom Up		\$83
	Top Down-Bottom Up		\$166
DESIGNER UPGRADE OPTIONS (Add to any Lift System Upgrade Above)			ADD
Metallic Hardware or Fabric Wrapped Hardware			\$22
Scotchgard Stain Protection			\$35
MOTORIZATION			MORE INFO
			ADD
PowerTouch Rechargeable		Pg 76	\$110
Simplicity - Motor and Battery Wand		Pg 70	\$334
Simplicity Rechargeable Motorization - Motor with Integrated Battery		Pg 72	\$334
Plug-In Charger for Li-Ion Battery Pack (used for PowerTouch and Simplicity Rechargeable and is required)		Pg 76	\$27
Simplicity 5 Channel Remote		Pg 74	\$40
Simplicity 6 Channel Remote with Timer		Pg 74	\$65
Simplicity Smart Controller (NEO)		Pg 75	\$330
Motorized Pricing Examples		Pg 9	
ADDITIONAL OPTIONS			
Insulating SlumberShades	\$134 See Page 80 For More Information		
Two-On-One Head Rail	\$50 Add to Cord Lock Shade and add lift system upgrade		
Cut Outs	\$52 Per side		
Day-Night	Price each panel as separate shade and add together		
Highlights Cornice Valance	See Page 121 For More Information		
Prints & Custom Graphics	Add 20% - Includes Anna Cote, Gradients, Spheres, Tuscan Scroll, Homespun, Florence, Strata, Blossom, Country Woven and Custom Graphics		

Debut 1/2" Single Cell

Price Group 9
Cord Lock
Cordless Lift & Lock

Standard Rectangular

		Width In Inches														
		24	30	36	42	48	54	60	66	72	84	96	108	120	132	144
Length In Inches	36	129	144	165	184	204	222	241	258	277	319	359	397	440	480	520
	42	138	158	178	201	222	242	265	285	306	352	396	441	489	535	577
	48	146	170	194	217	241	264	287	312	335	385	434	483	536	585	635
	54	157	180	206	233	259	284	309	336	364	417	473	527	583	639	692
	60	166	193	222	248	276	305	332	363	392	449	509	569	628	689	750
	66	175	204	236	265	296	326	356	388	419	481	548	612	678	740	806
	72	184	214	248	283	314	348	382	414	447	514	585	655	725	793	864
	78	194	228	262	294	333	366	403	439	475	546	623	696	770	845	917
	84	200	237	275	312	350	385	424	461	499	575	656	731	813	890	970
	90	209	247	287	326	367	407	446	486	530	609	691	774	857	941	1024
	96	217	258	301	341	384	425	468	510	552	638	726	812	902	986	1075
	108	237	279	326	370	420	464	511	557	605	699	795	890	989	1084	1180
120	252	302	353	403	457	506	556	608	658	761	867	971	1076	1182	1286	

Widths over 108" will be built as Two-On-One Shades.

LIFT SYSTEM AND DESIGN UPGRADES			ADD
Cord Lock	Top Down-Bottom Up		\$64
Cordless Lift & Lock	Bottom Up		No Charge
	Top Down-Bottom Up		\$83
Cordless Ultra	Bottom Up		\$83
	Top Down-Bottom Up		\$166
Cord Loop	Bottom Up		\$83
	Top Down-Bottom Up		\$166
DESIGNER UPGRADE OPTIONS (Add to any Lift System Upgrade Above)			ADD
Metallic Hardware or Fabric Wrapped Hardware			\$22
Scotchgard Stain Protection			\$35
MOTORIZATION			MORE INFO
PowerTouch Rechargeable			Pg 76 \$110
Simplicity - Motor and Battery Wand			Pg 70 \$334
Simplicity Rechargeable Motorization - Motor with Integrated Battery			Pg 72 \$334
Plug-In Charger for Li-Ion Battery Pack (used for PowerTouch and Simplicity Rechargeable and is required)			Pg 76 \$27
Simplicity 5 Channel Remote			Pg 74 \$40
Simplicity 6 Channel Remote with Timer			Pg 74 \$65
Simplicity Smart Controller (NEO)			Pg 75 \$330
Motorized Pricing Examples			Pg 9
ADDITIONAL OPTIONS			
Insulating SlumberShades		\$134 See Page 80 For More Information	
Two-On-One Head Rail		\$50 Add to Cord Lock Shade and add lift system upgrade	
Cut Outs		\$52 Per side	
Day-Night		Price each panel as separate shade and add together	
Highlights Cornice Valance		See Page 121 For More Information	
Prints & Custom Graphics		Add 20% - Includes solid colors, Homespun, Country Woven, Florance, Strata, Angel Hair, Blossom, Strie and Terrazzo.	

Debut 3/4" Single Cell
Debut 1/2" Double Cell

Price Group 10
Cord Lock
Cordless Lift & Lock

Standard Rectangular

		Width In Inches														
		24	30	36	42	48	54	60	66	72	84	96	108	120	132	144
Length In Inches	36	142	159	182	203	225	245	266	284	305	351	395	437	484	528	572
	42	152	174	196	222	245	267	292	314	337	388	436	486	538	589	635
	48	161	187	214	239	266	291	316	344	369	424	478	532	590	644	699
	54	173	198	227	257	285	313	340	370	401	459	521	580	642	703	762
	60	183	213	245	273	304	336	366	400	432	494	560	626	691	758	825
	66	193	225	260	292	326	359	392	427	461	530	603	674	746	814	887
	72	203	236	273	312	346	383	421	456	492	566	644	721	798	873	951
	78	214	251	289	324	367	403	444	483	523	601	686	766	847	930	1009
	84	220	261	303	344	385	424	467	508	549	633	722	805	895	979	1067
	90	230	272	316	359	404	448	491	535	583	670	761	852	943	1036	1127
	96	239	284	332	376	423	468	515	561	608	702	799	894	993	1085	1183
	108	261	307	359	407	462	511	563	613	666	769	875	979	1088	1193	1298
120	278	333	389	444	503	557	612	669	724	838	954	1069	1184	1301	1415	

Widths over 108" will be built as Two-On-One Shades.

LIFT SYSTEM AND DESIGN UPGRADES		ADD	
Cord Lock	Top Down-Bottom Up	\$64	
Cordless Lift & Lock	Bottom Up	No Charge	
	Top Down-Bottom Up	\$83	
Cordless Ultra	Bottom Up	\$83	
	Top Down-Bottom Up	\$166	
Cord Loop	Bottom Up	\$83	
	Top Down-Bottom Up	\$166	
DESIGNER UPGRADE OPTIONS (Add to any Lift System Upgrade Above)		ADD	
Metallic Hardware or Fabric Wrapped Hardware		\$22	
Scotchgard Stain Protection		\$35	
MOTORIZATION		MORE INFO	ADD
PowerTouch Rechargeable		Pg 76	\$110
Simplicity - Motor and Battery Wand		Pg 70	\$334
Simplicity Rechargeable Motorization - Motor with Integrated Battery		Pg 72	\$334
Plug-In Charger for Li-Ion Battery Pack (used for PowerTouch and Simplicity Rechargeable and is required)		Pg 76	\$27
Simplicity 5 Channel Remote		Pg 74	\$40
Simplicity 6 Channel Remote with Timer		Pg 74	\$65
Simplicity Smart Controller (NEO)		Pg 75	\$330
Motorized Pricing Examples		Pg 9	
ADDITIONAL OPTIONS			
Insulating SlumberShades		\$134 See Page 80 For More Information	
Two-On-One Head Rail		\$50 Add to Cord Lock Shade and add lift system upgrade	
Cut Outs		\$52 Per side	
Day-Night		Price each panel as separate shade and add together	
Highlights Cornice Valance		See Page 121 For More Information	
Prints & Custom Graphics		Add 20% - Includes solid colors, Homespun, Country Woven, Florance, Strata, Angel Hair, Blossom, Strie and Terrazzo.	

Symphony 3/8" Light Filtering

Price Group 11
Cord Lock
Cordless Lift & Lock

Standard Rectangular

Length In Inches	Width In Inches														
	24	30	36	42	48	54	60	66	72	84	96	108	120	132	144
36	122	137	157	175	194	211	229	245	263	303	341	378	419	457	495
42	131	150	169	191	211	230	252	271	291	335	377	420	465	509	549
48	139	161	184	206	229	251	273	297	319	366	413	460	510	557	604
54	149	171	196	221	246	270	294	320	346	397	450	501	555	608	659
60	158	183	211	236	262	290	316	345	373	427	484	541	598	656	714
66	166	194	224	252	281	310	339	369	399	458	521	582	645	704	767
72	175	203	236	269	299	331	363	394	425	489	557	623	690	755	822
78	184	217	249	280	317	348	383	418	452	520	593	662	733	804	873
84	190	225	261	297	333	366	403	439	475	547	624	696	774	847	923
90	199	235	273	310	349	387	424	462	504	580	658	737	816	896	975
96	206	245	286	324	365	404	445	485	525	607	691	773	859	939	1023
108	225	265	310	352	400	441	486	530	576	665	757	847	941	1032	1123
120	240	287	336	383	435	481	529	579	626	724	825	924	1024	1125	1224

 Cord Loop Hardware is recommended on sizes within the shaded area.
Motorized Lift Systems are not offered within the shaded area.

Widths over 108" will be built as Two-On-One Shades.

FABRIC SURCHARGES		ADD	
Prints and Duotones		20%	
Flame Resistant 3/8" double cell		30%	
Flame Resistant 3/4" single cell		30%	
LIFT SYSTEM AND DESIGN UPGRADES		ADD	
Cord Lock	Top Down-Bottom Up	\$64	
Cordless Lift & Lock	Bottom Up	No Charge	
	Top Down-Bottom Up	\$83	
Cordless Ultra	Bottom Up	\$83	
	Top Down-Bottom Up	\$166	
Cord Loop	Bottom Up	\$83	
	Top Down-Bottom Up	\$166	
DESIGNER UPGRADE OPTIONS (Add to any Lift System Upgrade Above)		ADD	
Metallic Hardware or Fabric Wrapped Hardware		\$22	
Scotchgard Stain Protection		\$35	
MOTORIZATION		MORE INFO	ADD
PowerTouch Rechargeable		Pg 76	\$110
Simplicity - Motor and Battery Wand		Pg 70	\$334
Simplicity Rechargeable Motorization - Motor with Integrated Battery		Pg 72	\$334
Plug-In Charger for Li-Lon Battery Pack (used for PowerTouch and Simplicity Rechargeable and is required)		Pg 76	\$27
Simplicity 5 Channel Remote		Pg 74	\$40
Simplicity 6 Channel Remote with Timer		Pg 74	\$65
Simplicity Smart Controller (NEO)		Pg 75	\$330
Motorized Pricing Examples		Pg 9	
ADDITIONAL OPTIONS			
Insulating SlumberShades		\$134 See Page 80 For More Information	
Two-On-One Head Rail		\$50 Add to Cord Lock Shade and add lift system upgrade	
Cut Outs		\$52 Per side	
Day-Night		Price each panel as separate shade and add together	
Highlights Cornice Valance		See Page 121 For More Information	

Symphony 3/8" Blackout

Price Group 12
Cord Lock
Cordless Lift & Lock

Standard Rectangular

		Width In Inches														
		24	30	36	42	48	54	60	66	72	84	96	108	120	132	144
Length In Inches	36	159	179	205	228	253	275	298	319	342	394	444	492	545	595	644
	42	171	195	220	249	275	299	328	353	379	436	491	546	605	662	714
	48	181	210	240	268	298	327	355	387	415	476	537	598	663	725	786
	54	194	223	255	288	320	351	383	416	450	517	585	652	722	791	857
	60	206	238	275	307	341	377	411	449	485	556	630	704	778	853	929
	66	216	253	292	328	366	403	441	480	519	596	678	757	839	916	998
	72	228	264	307	350	389	431	472	513	553	636	725	810	897	982	1069
	78	240	283	324	364	413	453	498	544	588	676	771	861	953	1046	1135
	84	247	293	340	387	433	476	524	571	618	712	812	905	1007	1102	1200
	90	259	306	355	403	454	504	552	601	656	754	856	959	1061	1165	1268
	96	268	319	372	422	475	526	579	631	683	790	899	1005	1117	1221	1330
	108	293	345	403	458	520	574	632	689	749	865	985	1102	1224	1342	1460
120	312	374	437	498	566	626	688	753	814	942	1073	1202	1332	1463	1592	

 Cord Loop Hardware is recommended on sizes within the shaded area.
Motorized Lift Systems are not offered within the shaded area.

Widths over 120" will be built as Two-On-One Shades.

LIFT SYSTEM AND DESIGN UPGRADES		ADD	
Cord Lock	Top Down-Bottom Up	\$64	
Cordless Lift & Lock	Bottom Up	No Charge	
	Top Down-Bottom Up	\$83	
Cord Loop	Bottom Up	\$83	
	Top Down-Bottom Up	\$166	
DESIGNER UPGRADE OPTIONS (Add to any Lift System Upgrade Above)		ADD	
Metallic Hardware or Fabric Wrapped Hardware		\$22	
Scotchgard Stain Protection		\$35	
MOTORIZATION		MORE INFO	ADD
PowerTouch Rechargeable		Pg 76	\$110
Simplicity - Motor and Battery Wand		Pg 70	\$334
Simplicity Rechargeable Motorization - Motor with Integrated Battery		Pg 72	\$334
Plug-In Charger for Li-Ion Battery Pack (used for PowerTouch and Simplicity Rechargeable and is required)		Pg 76	\$27
Simplicity 5 Channel Remote		Pg 74	\$40
Simplicity 6 Channel Remote with Timer		Pg 74	\$65
Simplicity Smart Controller (NEO)		Pg 75	\$330
Motorized Pricing Examples		Pg 9	
ADDITIONAL OPTIONS			
Insulating SlumberShades		\$134 See Page 80 For More Information	
Two-On-One Head Rail		\$50 Add to Cord Lock Shade and add lift system upgrade	
Cut Outs		\$52 Per side	
Day-Night		Price each panel as separate shade and add together	
Highlights Cornice Valance		See Page 121 For More Information	

Baritone 3/4" Light Filtering*
(Not in 2017 Sample Book)

Price Group 13
Cord Lock
Cordless Lift & Lock

Standard Rectangular

		Width In Inches														
		24	30	36	42	48	54	60	66	72	84	96	108	120	132	144
Length In Inches	36	129	144	165	184	204	222	241	258	277	319	359	397	440	480	520
	42	138	158	178	201	222	242	265	285	306	352	396	441	489	535	577
	48	146	170	194	217	241	264	287	312	335	385	434	483	536	585	635
	54	157	180	206	233	259	284	309	336	364	417	473	527	583	639	692
	60	166	193	222	248	276	305	332	363	392	449	509	569	628	689	750
	66	175	204	236	265	296	326	356	388	419	481	548	612	678	740	806
	72	184	214	248	283	314	348	382	414	447	514	585	655	725	793	864
	78	194	228	262	294	333	366	403	439	475	546	623	696	770	845	917
	84	200	237	275	312	350	385	424	461	499	575	656	731	813	890	970
	90	209	247	287	326	367	407	446	486	530	609	691	774	857	941	1024
	96	217	258	301	341	384	425	468	510	552	638	726	812	902	986	1075
108	237	279	326	370	420	464	511	557	605	699	795	890	989	1084	1180	
120	252	302	353	403	457	506	556	608	658	761	867	971	1076	1182	1286	

 Cord Loop Hardware is recommended on sizes within the shaded area.
Motorized Lift Systems are not offered within the shaded area.

Widths over 120" will be built as Two-On-One Shades.

* The following Baritone colors are available up to 120" width: 1051, 1052, 1053, 1054, 1055, 1084, 1465, 1469 and 1857. All other colors not listed here are available in a maximum width of 108".

LIFT SYSTEM AND DESIGN UPGRADES		ADD	
Cord Lock	Top Down-Bottom Up	\$64	
Cordless Lift & Lock	Bottom Up	No Charge	
	Top Down-Bottom Up	\$83	
Cordless Ultra	Bottom Up	\$83	
	Top Down-Bottom Up	\$166	
Cord Loop	Bottom Up	\$83	
	Top Down-Bottom Up	\$166	
DESIGNER UPGRADE OPTIONS (Add to any Lift System Upgrade Above)		ADD	
Metallic Hardware or Fabric Wrapped Hardware		\$22	
Scotchgard Stain Protection		\$35	
MOTORIZATION		MORE INFO	ADD
PowerTouch Rechargeable		Pg 76	\$110
Simplicity - Motor and Battery Wand		Pg 70	\$334
Simplicity Rechargeable Motorization - Motor with Integrated Battery		Pg 72	\$334
Plug-In Charger for Li-Lon Battery Pack (used for PowerTouch and Simplicity Rechargeable and is required)		Pg 76	\$27
Simplicity 5 Channel Remote		Pg 74	\$40
Simplicity 6 Channel Remote with Timer		Pg 74	\$65
Simplicity Smart Controller (NEO)		Pg 75	\$330
Motorized Pricing Examples		Pg 9	
ADDITIONAL OPTIONS			
Insulating SlumberShades		\$134 See Page 80 For More Information	
Two-On-One Head Rail		\$50 Add to Cord Lock Shade and add lift system upgrade	
Cut Outs		\$52 Per side	
Day-Night		Price each panel as separate shade and add together	
Highlights Cornice Valance		See Page 121 For More Information	

Baritone 3/4" Blackout*

(Not in 2017 Sample Book)

**Price Group 14
Cord Lock
Cordless Lift & Lock**

Standard Rectangular

		Width In Inches														
		24	30	36	42	48	54	60	66	72	84	96	108	120	132	144
Length In Inches	36	168	188	215	240	266	289	314	336	361	415	467	517	572	624	676
	42	180	206	232	262	289	315	345	371	398	458	515	574	636	696	751
	48	190	221	253	283	314	344	374	406	436	501	565	628	697	761	826
	54	205	234	268	303	337	370	402	437	474	543	615	686	758	831	900
	60	216	251	289	323	359	397	432	472	510	584	662	740	817	896	975
	66	228	266	307	345	385	424	463	505	545	626	713	796	882	962	1048
	72	240	279	323	368	409	453	497	539	582	669	761	852	943	1031	1124
	78	253	297	341	383	433	476	524	571	618	710	810	905	1001	1099	1193
	84	260	309	358	406	455	501	552	600	649	748	853	951	1057	1157	1261
	90	272	322	374	424	478	530	580	632	689	792	899	1007	1115	1224	1332
96	283	336	392	444	500	553	609	663	718	830	944	1056	1173	1282	1398	
108	309	363	424	481	546	604	665	725	787	909	1034	1157	1286	1410	1534	
120	328	393	459	524	595	658	723	791	856	990	1128	1263	1399	1537	1672	

■ Cord Loop Hardware is recommended on sizes within the shaded area.
Motorized Lift Systems are not offered within the shaded area.

Widths over 120" will be built as Two-On-One Shades.

* The following colors are available up to 120" width: 1951, 1952, 1953, 1955, 1784, 1964, 1965, 1969 and 1959.
All other colors not listed here are available in a maximum width of 108".

LIFT SYSTEM AND DESIGN UPGRADES		ADD	
Cord Lock	Top Down-Bottom Up	\$64	
Cordless Lift & Lock	Bottom Up	No Charge	
	Top Down-Bottom Up	\$83	
Cordless Ultra	Bottom Up	\$83	
	Top Down-Bottom Up	\$166	
Cord Loop	Bottom Up	\$83	
	Top Down-Bottom Up	\$166	
DESIGNER UPGRADE OPTIONS (Add to any Lift System Upgrade Above)		ADD	
Metallic Hardware or Fabric Wrapped Hardware		\$22	
Scotchgard Stain Protection		\$35	
MOTORIZATION		MORE INFO	ADD
PowerTouch Rechargeable		Pg 76	\$110
Simplicity - Motor and Battery Wand		Pg 70	\$334
Simplicity Rechargeable Motorization - Motor with Integrated Battery		Pg 72	\$334
Plug-In Charger for Li-Lon Battery Pack (used for PowerTouch and Simplicity Rechargeable and is required)		Pg 76	\$27
Simplicity 5 Channel Remote		Pg 74	\$40
Simplicity 6 Channel Remote with Timer		Pg 74	\$65
Simplicity Smart Controller (NEO)		Pg 75	\$330
Motorized Pricing Examples		Pg 9	
ADDITIONAL OPTIONS			
Insulating SlumberShades	\$134 See Page 80 For More Information		
Two-On-One Head Rail	\$50 Add to Cord Lock Shade and add lift system upgrade		
Cut Outs	\$52 Per side		
Day-Night	Price each panel as separate shade and add together		
Highlights Cornice Valance	See Page 121 For More Information		

Virtuoso 1/2" Light Filtering*
(Not in 2017 Sample Book)

Price Group 15
Cord Lock
Cordless Lift & Lock

Standard Rectangular

		Width In Inches														
		24	30	36	42	48	54	60	66	72	84	96	108	120	132	144
Length In Inches	36	116	131	150	167	185	201	218	233	250	288	324	360	399	435	471
	42	125	143	161	182	201	219	240	258	277	319	359	399	442	484	522
	48	133	153	175	196	218	239	260	283	304	348	393	437	485	530	574
	54	142	163	187	210	234	257	280	304	329	378	428	476	528	578	627
	60	151	174	201	225	249	276	301	328	355	406	460	514	569	624	679
	66	158	185	213	240	267	295	323	351	380	436	495	553	613	669	729
	72	167	193	225	256	285	315	345	375	404	465	530	592	656	718	781
	78	175	207	237	266	302	331	364	398	430	494	564	629	697	764	830
	84	181	214	248	283	317	348	383	418	452	520	593	662	736	805	877
	90	190	224	260	295	332	368	403	439	479	551	626	701	776	852	927
	96	196	233	272	308	347	384	423	461	499	577	657	735	817	893	972
108	214	252	295	335	380	419	462	504	548	632	720	805	894	981	1067	
120	228	273	320	364	414	457	503	551	595	688	784	878	973	1069	1163	

* The following Virtuoso colors are available up to 120" width: 400, 401, 408, 423, 424 and 431. All other colors not listed here are available in a maximum width of 108".

Widths over 120" will be built as Two-On-One Shades.

LIFT SYSTEM AND DESIGN UPGRADES		ADD	
Cord Lock	Top Down-Bottom Up	\$64	
Cordless Lift & Lock	Bottom Up	No Charge	
	Top Down-Bottom Up	\$83	
Cordless Ultra	Bottom Up	\$83	
	Top Down-Bottom Up	\$166	
Cord Loop	Bottom Up	\$83	
	Top Down-Bottom Up	\$166	
DESIGNER UPGRADE OPTIONS (Add to any Lift System Upgrade Above)		ADD	
Metallic Hardware or Fabric Wrapped Hardware		\$22	
Scotchgard Stain Protection		\$35	
MOTORIZATION		MORE INFO	ADD
PowerTouch Rechargeable		Pg 76	\$110
Simplicity - Motor and Battery Wand		Pg 70	\$334
Simplicity Rechargeable Motorization - Motor with Integrated Battery		Pg 72	\$334
Plug-In Charger for Li-Lon Battery Pack (used for PowerTouch and Simplicity Rechargeable and is required)		Pg 76	\$27
Simplicity 5 Channel Remote		Pg 74	\$40
Simplicity 6 Channel Remote with Timer		Pg 74	\$65
Simplicity Smart Controller (NEO)		Pg 75	\$330
Motorized Pricing Examples		Pg 9	
ADDITIONAL OPTIONS			
Insulating SlumberShades		\$134 See Page 80 For More Information	
Two-On-One Head Rail		\$50 Add to Cord Lock Shade and add lift system upgrade	
Cut Outs		\$52 Per side	
Day-Night		Price each panel as separate shade and add together	
Highlights Cornice Valance		See Page 121 For More Information	

Virtuoso 1/2" Blackout

(Not in 2017 Sample Book)

**Price Group 16
Cord Lock
Cordless Lift & Lock**

Standard Rectangular

		Width In Inches														
		24	30	36	42	48	54	60	66	72	84	96	108	120	132	144
Length In Inches	36	151	171	195	218	241	262	284	303	325	375	422	468	519	566	613
	42	163	186	210	237	262	285	312	336	361	415	467	519	575	630	679
	48	173	199	228	255	284	311	338	368	396	453	511	569	631	689	747
	54	185	212	244	273	305	335	364	396	428	492	557	619	687	752	816
	60	197	227	262	293	324	359	392	427	462	528	598	669	740	812	883
	66	206	241	277	312	348	384	420	457	494	567	644	719	797	870	948
	72	218	251	293	333	371	410	449	488	526	605	689	770	853	934	1016
	78	228	270	309	346	393	431	474	518	559	643	734	818	907	994	1079
	84	236	279	323	368	413	453	498	544	588	676	771	861	957	1047	1141
	90	247	292	338	384	432	479	524	571	623	717	814	912	1009	1108	1206
96	255	303	354	401	452	500	550	600	649	751	855	956	1063	1161	1264	
108	279	328	384	436	494	545	601	656	713	822	936	1047	1163	1276	1388	
120	297	355	416	474	539	595	654	717	774	895	1020	1142	1265	1390	1512	

■ Cord Loop Hardware is recommended on sizes within the shaded area.
 ■ Motorized Lift Systems are not offered within the shaded area.

Widths over 120" will be built as Two-On-One Shades.

LIFT SYSTEM AND DESIGN UPGRADES		ADD	
Cord Lock	Top Down-Bottom Up	\$64	
Cordless Lift & Lock	Bottom Up	No Charge	
	Top Down-Bottom Up	\$83	
Cordless Ultra	Bottom Up	\$83	
	Top Down-Bottom Up	\$166	
Cord Loop	Bottom Up	\$83	
	Top Down-Bottom Up	\$166	
DESIGNER UPGRADE OPTIONS (Add to any Lift System Upgrade Above)		ADD	
Metallic Hardware or Fabric Wrapped Hardware		\$22	
Scotchgard Stain Protection		\$35	
MOTORIZATION		MORE INFO	ADD
PowerTouch Rechargeable		Pg 76	\$110
Simplicity - Motor and Battery Wand		Pg 70	\$334
Simplicity Rechargeable Motorization - Motor with Integrated Battery		Pg 72	\$334
Plug-In Charger for Li-Lon Battery Pack (used for PowerTouch and Simplicity Rechargeable and is required)		Pg 76	\$27
Simplicity 5 Channel Remote		Pg 74	\$40
Simplicity 6 Channel Remote with Timer		Pg 74	\$65
Simplicity Smart Controller (NEO)		Pg 75	\$330
Motorized Pricing Examples		Pg 9	
ADDITIONAL OPTIONS			
Insulating SlumberShades	\$134 See Page 80 For More Information		
Two-On-One Head Rail	\$50 Add to Cord Lock Shade and add lift system upgrade		
Cut Outs	\$52 Per side		
Day-Night	Price each panel as separate shade and add together		
Highlights Cornice Valance	See Page 121 For More Information		

Prelude 3/4" Light Filtering

Price Group 17
Cord Lock
Cordless Lift & Lock

		Width In Inches												
		24	30	36	42	48	54	60	66	72	84	96	108	120
Length In Inches	36	110	124	142	158	175	190	207	221	237	273	307	341	378
	42	118	135	153	172	190	207	227	244	262	302	340	378	419
	48	126	145	166	186	207	226	246	268	288	330	372	414	459
	54	135	154	177	199	222	243	265	288	312	358	405	451	500
	60	143	165	190	213	236	261	285	311	336	385	436	487	539
	66	150	175	202	227	253	279	306	333	360	413	469	524	581
	72	158	183	213	243	270	298	327	355	383	441	502	561	621
	78	166	196	225	252	286	314	345	377	407	468	534	596	660
	84	171	203	235	268	300	330	363	396	428	493	562	627	697
	90	180	212	246	279	315	349	382	416	454	522	593	664	735
	96	186	221	258	292	329	364	401	437	473	547	622	696	774
108	203	239	279	317	360	397	438	477	519	599	682	763	847	
120	216	259	303	345	392	433	477	522	564	652	743	832	922	

■ Cord Loop Hardware is recommended on sizes within the shaded area.
Motorized lift systems are not offered within the shaded area.

Prelude Cellular Shades

LIFT SYSTEM AND DESIGN UPGRADES		ADD	
Cord Lock	Top Down-Bottom Up	\$64	
Cordless Lift & Lock	Bottom Up	No Charge	
	Top Down-Bottom Up	\$83	
Cordless Ultra	Bottom Up	\$83	
	Top Down-Bottom Up	\$166	
Cord Loop	Bottom Up	\$83	
	Top Down-Bottom Up	\$166	
DESIGNER UPGRADE OPTIONS (Add to any Lift System Upgrade Above - Not available on Cord Lock)		ADD	
Metallic Hardware (Not available on Lift & Lock or Cord Lock) or Fabric Wrapped Hardware (Not available on Cord Lock)		\$22	
MOTORIZATION		MORE INFO	ADD
Simplicity - Motor and Battery Wand (Simplicity Rechargeable not available with Prelude)		Pg 70	\$334
Simplicity 5 Channel Remote		Pg 70	\$40
Motorized Pricing Examples		Pg 9	
ADDITIONAL OPTIONS AND ACCESSORIES			
Insulating SlumberShades		Not Available	
Two-On-One Head Rail		\$50 Add to Cord Lock Shade and add lift system upgrade	
Highlights Cornice Valance		See Page 121 For More Information	
5 foot expandable pole		\$37	

Prelude 3/4" Blackout

Price Group 18
Cord Lock
Cordless Lift & Lock

Prelude Cellular Shades

		Width In Inches												
		24	30	36	42	48	54	60	66	72	84	96	108	120
Length In Inches	36	149	168	192	214	237	257	280	299	320	369	415	461	511
	42	160	183	207	233	257	280	307	330	354	408	459	511	566
	48	171	196	225	252	280	306	333	362	389	446	503	559	620
	54	183	208	239	269	300	329	358	389	422	484	547	609	675
	60	194	223	257	288	319	353	385	420	454	520	589	658	728
	66	203	237	273	307	342	377	414	450	486	558	634	708	785
	72	214	248	288	329	365	403	442	480	518	596	678	758	839
	78	225	265	304	341	387	424	466	509	550	632	721	805	891
	84	231	275	318	362	405	446	491	535	578	666	759	847	941
	90	243	287	333	377	426	472	516	562	613	705	801	897	993
	96	252	299	349	395	445	492	542	590	639	739	840	940	1045
	108	275	323	377	428	486	536	592	644	701	809	921	1031	1144
	120	292	350	410	466	530	585	644	705	762	881	1004	1124	1245

■ Cord Loop Hardware is recommended on sizes within the shaded area.
Motorized lift systems are not offered within the shaded area.

LIFT SYSTEM AND DESIGN UPGRADES		ADD	
Cord Lock	Top Down-Bottom Up	\$64	
Cordless Lift & Lock	Bottom Up	No Charge	
	Top Down-Bottom Up	\$83	
Cordless Ultra	Bottom Up	\$83	
	Top Down-Bottom Up	\$166	
Cord Loop	Bottom Up	\$83	
	Top Down-Bottom Up	\$166	
DESIGNER UPGRADE OPTIONS (Add to any Lift System Upgrade Above - Not available on Cord Lock)		ADD	
Metallic Hardware (Not available on Lift & Lock or Cord Lock) or Fabric Wrapped Hardware (Not available on Cord Lock)		\$22	
MOTORIZATION		MORE INFO	ADD
Simplicity - Motor and Battery Wand (Simplicity Rechargeable not available with Prelude)		Pg 70	\$334
Simplicity 5 Channel Remote		Pg 70	\$40
Motorized Pricing Examples		Pg 9	
ADDITIONAL OPTIONS AND ACCESSORIES			
Insulating SlumberShades		Not Available	
Two-On-One Head Rail		\$50 Add to Cord Lock Shade and add lift system upgrade	
Highlights Cornice Valance		See Page 121 For More Information	
5 foot expandable pole		\$37	

Privada Privacy Pleated Light Filtering

Price Group 19
Cord Lock
Cordless Lift & Lock

Standard Rectangular

		Width In Inches														
		24	30	36	42	48	54	60	66	72	84	96	108	120	132	144
Length In Inches	36	104	117	134	149	165	180	195	209	224	258	290	322	357	389	421
	42	112	128	144	163	180	196	215	231	248	285	321	357	396	433	467
	48	119	137	157	176	195	214	233	253	272	312	352	391	434	474	514
	54	127	146	167	188	210	230	250	272	295	338	383	426	472	517	561
	60	135	156	180	201	223	247	269	294	318	363	412	460	509	558	607
	66	142	165	191	215	239	264	289	314	340	390	443	495	549	599	652
	72	149	173	201	229	255	282	309	335	362	416	474	530	587	642	699
	78	157	185	212	238	270	296	326	356	385	442	505	563	624	684	743
	84	162	192	222	253	284	312	343	374	404	465	531	592	658	720	785
	90	170	200	233	264	297	329	361	393	429	493	560	627	694	762	829
	96	176	209	244	276	311	344	379	413	447	516	588	658	731	799	870
108	192	226	264	300	340	375	414	451	490	566	644	720	800	878	955	
120	204	244	286	326	370	409	450	493	533	616	702	786	871	957	1041	

Motorized lift systems are not offered within the shaded area.

Widths over 108" will be built as Two-On-One Shades.

FABRIC SURCHARGES			
Strie Light Filtering		Add 20%	
Linen		Add 30%	
LIFT SYSTEM AND DESIGN UPGRADES		ADD	
Cord Lock	Top Down-Bottom Up	\$64	
Cordless Ultra	Bottom Up	\$83	
	Top Down-Bottom Up	\$166	
Cord Loop	Bottom Up	\$83	
	Top Down-Bottom Up	\$166	
DESIGNER UPGRADE OPTIONS (Add to any Lift System Upgrade Above)		ADD	
Metallic Hardware or Fabric Wrapped Hardware		\$22	
Scotchgard Stain Protection		\$35	
MOTORIZATION		MORE INFO	ADD
Simplicity - Motor and Battery Wand		Pg 70	\$334
Simplicity 5 Channel Remote		Pg 74	\$40
Simplicity 6 Channel Remote with Timer		Pg 74	\$65
Simplicity Smart Controller (NEO)		Pg 75	\$330
Motorized Pricing Examples		Pg 9	
ADDITIONAL OPTIONS			
Insulating SlumberShades		Not Available	
Two-On-One Head Rail		\$50 Add to Cord Lock Shade and add lift system upgrade	
Cut Outs		\$52 Per side	
Highlights Cornice Valance		See Page 121 For More Information	

Privada Privacy Pleated Fabric Characteristics

Privada fabrics have an inherent wave in the pleat when viewing the shade from the back. This wave does not appear on the front of the shade.

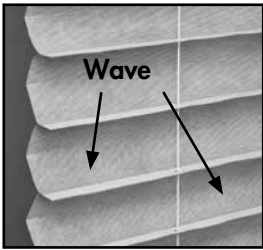

Privada Privacy Pleated Shade Stack

Privada fabrics stack in a curve due to the cords being located along the back of the shade. This effects the shade's stack height and the stack may appear to be larger than the measurements provided on pages 15-16.



Ovation Cellular Slider Shade Size Standards



Ovation Cellular Slider Standard

ALL FABRICS	Minimum Width	12"
	Minimum Length	24"



Light Filtering	Price Group	Page		Ovation Cellular Slider
Debut 1/2" Single Debut 1/2" Double Premiere 1/2" Silk Essence 1/2" Symphony 3/8" Virtuoso 1/2"	20	38	Maximum Width & Length	120"* x 108"
Verona 3/4" Boutique 3/4" Baritone 3/4" Debut 3/4" Linen Weave 3/4" Premiere 3/4"	20	38	Maximum Width & Length	168"* x 120"
Prelude 3/4"	21	38	Maximum Width & Length	168"* x 120"



Room Darkening & Blackout	Price Group	Page		Ovation Cellular Slider
Symphony 3/8"	22	39	Maximum Width & Length	120"* x 108"
Verona 3/4" Boutique 3/4" Baritone 3/4" Linen Weave 3/4" Premiere 3/4"	22	39	Maximum Width & Length	168"* x 120"
Prelude 3/4"	23	39	Maximum Width & Length	168"* x 120"

Maximum Square Footage Side=100"
Split=140"

	Ovation Cellular Slider
More Information On Page	Page 78

- * Split stack sliders are available in widths up to 240"; however, if the width exceeds 120", it will be fabricated as two separate sliders. The supplied valance will create the appearance of a single slider.
- ** Split stack sliders are available to 336", however if the width exceeds 168", the shade will be fabricated as two separate sliders. Supplied valance will create the appearance of a single slider. Please call customer service for assistance.
- *** Prelude split stack can go up to 190" wide on one head rail.

LIGHT FILTERING FABRICS

Baritone 3/4"
 Boutique 3/4"
 Debut 1/2 Single Cell
 Debut 1/2" Double Cell

Debut 3/4" Single Cell
 Linen Weave 3/4"
 Premiere 1/2"
 Premiere 3/4"

Silk Essence 1/2"
 Symphony 3/8"
 Verona 3/4"
 Virtuoso 1/2"

**Price Group 20
 Ovation Cellular Slider**

		Width In Inches																	
		24	30	36	42	48	54	60	66	72	78	84	96	108	120	132	144	156	168
Length In Inches	36	447	484	527	567	601	641	682	719	758	799	834	904	973	1047	1118	1192	1265	1338
	42	477	521	568	614	653	697	744	785	831	875	913	995	1071	1158	1242	1328	1413	1498
	48	508	554	611	658	702	751	802	854	902	946	996	1088	1172	1267	1360	1455	1547	1642
	54	536	591	649	704	753	806	858	918	973	1023	1076	1177	1273	1377	1481	1583	1689	1791
	60	566	625	688	748	802	862	922	984	1041	1099	1155	1268	1373	1485	1601	1713	1828	1943
	66	598	663	730	796	854	917	978	1052	1111	1177	1231	1360	1473	1594	1714	1836	1957	2078
	72	632	699	769	842	910	974	1040	1117	1183	1253	1314	1456	1571	1709	1845	1982	2118	2253
	78	663	736	813	890	961	1032	1102	1185	1256	1329	1394	1543	1670	1815	1960	2104	2249	2393
	84	697	773	853	939	1015	1088	1165	1251	1329	1406	1474	1634	1773	1923	2078	2231	2384	2536
	90	726	809	899	987	1064	1146	1229	1322	1402	1483	1559	1727	1870	2039	2208	2378	2547	2715
	96	757	845	940	1033	1116	1201	1294	1388	1474	1561	1641	1820	1972	2147	2319	2493	2669	2842
	108	786	879	981	1082	1166	1256	1356	1452	1546	1641	1722	1914	2075	2254	2431	2611	2789	2968
114	828	923	1032	1136	1226	1318	1432	1529	1628	1730	1814	2017	2188	2372	2548	2726	2902	3080	
120	867	968	1085	1192	1285	1383	1504	1605	1711	1819	1907	2121	2302	2490	2673	2858	3042	3227	

Prelude 3/4" Light Filtering

**Price Group 21
 Ovation Cellular Slider**

		Width In Inches																	
		24	30	36	42	48	54	60	66	72	78	84	96	108	120	132	144	156	168
Length In Inches	36	333	360	392	422	447	477	507	534	564	594	621	672	723	778	831	886	941	995
	42	354	387	423	457	486	518	553	584	618	650	679	739	796	861	924	988	1051	1114
	48	378	412	454	489	522	558	596	635	671	703	740	810	872	942	1011	1081	1151	1221
	54	398	440	483	523	559	599	639	683	723	761	801	875	946	1024	1101	1178	1256	1332
	60	421	465	512	557	596	640	685	731	774	818	859	943	1021	1105	1190	1274	1359	1445
	66	444	493	542	592	635	682	728	783	827	875	916	1011	1096	1186	1275	1366	1456	1546
	72	469	520	572	626	676	724	774	830	880	932	977	1082	1169	1270	1372	1474	1575	1675
	78	493	548	604	662	714	767	819	882	934	989	1036	1147	1242	1350	1458	1565	1673	1780
	84	518	575	634	698	755	810	866	930	989	1045	1097	1215	1318	1431	1546	1659	1773	1886
	90	540	602	668	734	792	852	914	982	1043	1103	1160	1285	1391	1516	1642	1768	1894	2019
	96	563	629	699	768	829	892	963	1032	1097	1161	1220	1353	1467	1596	1725	1854	1985	2114
	102	585	654	729	804	867	934	1008	1080	1150	1220	1280	1423	1543	1676	1809	1942	2074	2207
108	615	686	767	845	911	981	1064	1137	1211	1287	1350	1500	1628	1764	1895	2027	2159	2291	
114	645	720	807	886	955	1028	1118	1194	1272	1352	1418	1577	1711	1852	1989	2125	2262	2400	
120	675	754	845	927	1001	1076	1175	1251	1334	1419	1485	1654	1796	1939	2082	2224	2366	2510	

PRODUCT INFORMATION

See Page 78 for detailed information.

DESIGN UPGRADES

Left or Right Stack	Included, specify when ordering
Center Stack	Add \$84
Split Stack*	Price by dividing the full width measurement in half. Price as two separate units and add together.
Dual Panel**	Price as two separate units and add together.

* Split stack sliders are available in widths up to 240". If the width exceeds 120", it will be fabricated as two separate sliders. The supplied valance will create the appearance of a single slider.

** A Dual Panel Stack Slider has a center opening design with a different fabric on each side, each of which can span the full width of the window. Both panels will be of equal width unless otherwise specified.

ROOM DARKENING & BLACKOUT FABRICS

Baritone 3/4"
Boutique 3/4"

Linen Weave 3/4"
Premiere 3/4"

Verona 3/4"

**Price Group 22
Ovation Cellular Slider**

		Width In Inches																	
		24	30	36	42	48	54	60	66	72	78	84	96	108	120	132	144	156	168
Length In Inches	36	582	630	686	738	782	834	887	935	986	1039	1085	1176	1265	1362	1454	1550	1645	1740
	42	621	678	739	799	849	907	968	1021	1081	1138	1187	1294	1393	1506	1615	1727	1837	1948
	48	661	721	795	856	913	977	1043	1111	1173	1230	1295	1415	1524	1648	1768	1892	2012	2135
	54	697	769	844	916	979	1048	1116	1194	1265	1330	1399	1531	1655	1791	1926	2058	2196	2329
	60	736	813	895	973	1043	1121	1199	1280	1354	1429	1502	1649	1785	1931	2082	2227	2377	2526
	66	778	862	949	1035	1111	1193	1272	1368	1445	1531	1601	1768	1915	2073	2229	2387	2545	2702
	72	822	909	1000	1095	1183	1267	1352	1453	1538	1629	1709	1893	2043	2222	2399	2577	2754	2929
	78	862	957	1057	1157	1250	1342	1433	1541	1633	1728	1813	2006	2171	2360	2548	2736	2924	3111
	84	907	1005	1109	1221	1320	1415	1515	1627	1728	1828	1917	2125	2305	2500	2702	2901	3100	3297
	90	944	1052	1169	1284	1384	1490	1598	1719	1823	1928	2027	2246	2431	2651	2871	3092	3312	3530
	96	985	1099	1222	1343	1451	1562	1683	1805	1917	2030	2134	2366	2564	2792	3015	3241	3470	3695
108	1022	1143	1276	1407	1516	1633	1763	1888	2010	2134	2239	2489	2698	2931	3161	3395	3626	3859	
114	1077	1200	1342	1477	1594	1714	1862	1988	2117	2249	2359	2623	2845	3084	3313	3544	3773	4004	
120	1128	1259	1411	1550	1671	1798	1956	2087	2225	2365	2480	2758	2993	3237	3475	3716	3955	4196	

Prelude 3/4" Blackout

**Price Group 23
Ovation Cellular Slider**

		Width In Inches																	
		24	30	36	42	48	54	60	66	72	78	84	96	108	120	132	144	156	168
Length In Inches	36	450	486	530	570	604	644	685	721	762	802	839	908	977	1051	1122	1197	1271	1344
	42	478	523	572	617	657	700	747	789	835	878	917	998	1075	1163	1248	1334	1419	1504
	48	511	557	613	661	705	754	805	858	906	950	999	1094	1178	1272	1365	1460	1554	1649
	54	538	594	653	707	755	809	863	923	977	1028	1082	1182	1278	1383	1487	1591	1696	1799
	60	569	628	692	752	805	864	925	987	1045	1105	1160	1274	1379	1492	1607	1720	1835	1951
	66	600	666	732	800	858	921	983	1058	1117	1182	1237	1365	1480	1602	1722	1845	1966	2088
	72	634	702	773	846	913	978	1045	1121	1188	1259	1319	1461	1579	1715	1853	1990	2127	2262
	78	666	740	816	894	964	1036	1106	1191	1261	1336	1399	1549	1677	1823	1969	2113	2259	2403
	84	700	777	856	943	1020	1094	1170	1256	1336	1411	1481	1641	1780	1932	2088	2240	2394	2547
	90	729	813	902	991	1070	1151	1234	1326	1409	1490	1566	1735	1878	2047	2217	2387	2557	2726
	96	761	850	944	1037	1120	1205	1301	1394	1481	1568	1647	1827	1981	2155	2329	2503	2680	2854
102	790	883	985	1086	1171	1261	1361	1458	1553	1647	1728	1922	2084	2263	2443	2622	2800	2980	
108	831	927	1036	1141	1230	1325	1437	1535	1635	1738	1823	2025	2198	2382	2559	2737	2915	3093	
114	871	972	1090	1197	1290	1388	1510	1612	1718	1826	1915	2129	2310	2501	2686	2869	3054	3240	
120	912	1018	1141	1252	1352	1453	1587	1689	1801	1916	2005	2233	2425	2618	2811	3003	3195	3389	

PRODUCT INFORMATION

See Page 78 for detailed information.

DESIGN UPGRADES

Left or Right Stack	Standard
Center Stack	Add \$84
Split Stack*	Price by dividing the full width measurement in half. Price as two separate units and add together.
Dual Panel**	Price as two separate units and add together.

* Split stack sliders are available in widths up to 240". If the width exceeds 120", it will be fabricated as two separate sliders. The supplied valance will create the appearance of a single slider.

** A Dual Panel Stack Slider has a center opening design with a different fabric on each side, each of which can span the full width of the window. Both panels will be of equal width unless otherwise specified.

Specialty Shaped Shades



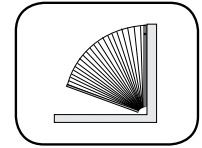
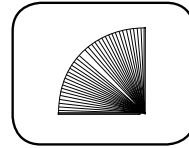
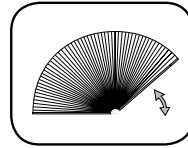
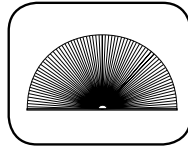

		Starburst Non-Movable Arch	Starburst Movable Arch	Quarter Round Non-Movable	Quarter Round Movable
ALL FABRICS (except 3/4" Prelude)	Minimum Width	18"	18"	9"	9"
	Minimum Length	9"	9"	9"	9"
Prelude 3/4"	Minimum Width	12"	12"	12"	12"
	Minimum Length	12"	12"	12"	12"

Light Filtering	Price Group	Page		Starburst Non-Movable Arch	Starburst Movable Arch	Quarter Round Non-Movable	Quarter Round Movable
Verona 3/4"	24	43	Maximum Width & Length	72" x 36"	72" x 36"	48" x 48"	48" x 48"
Boutique 3/4"				72" x 36"	72" x 36"	48" x 48"	48" x 46"
Baritone 3/4"				72" x 36"	72" x 36"	48" x 48"	48" x 48"
Debut 1/2" Double				60" x 48"	72" x 36"	48" x 48"	48" x 48"
Debut 1/2" Single				60" x 48"	72" x 36"	52" x 52"	48" x 48"
Debut 3/4"				60" x 48"	72" x 36"	48" x 48"	48" x 48"
Linen Weave 3/4"				72" x 36"	72" x 36"	48" x 48"	48" x 48"
Natural Linen Flax				60" x 48"	NA	NA	NA
Premiere 1/2"				60" x 48"	72" x 36"	48" x 48"	48" x 48"
Premiere 3/4"				72" x 36"	72" x 36"	48" x 48"	48" x 48"
Silk Essence 1/2"				60" x 48"	72" x 36"	52" x 52"	48" x 48"
Symphony 3/8"				96" x 48"	72" x 36"	52" x 52"	48" x 48"
Virtuoso 1/2"	60" x 48"	72" x 36"	52" x 52"	48" x 48"			
Prelude 3/4"	25	43	Max Width & Length	84" x 42"	84" x 42"	42" x 42"	42" x 42"

Room Darkening & Blackout	Price Group	Page #		Starburst Non-Movable Arch	Starburst Movable Arch	Quarter Round Non-Movable	Quarter Round Movable
Verona 3/4"	26	44	Maximum Width & Length	72" x 36"	72" x 36"	48" x 48"	48" x 48"
Boutique 3/4"				72" x 36"	72" x 36"	48" x 48"	48" x 48"
Baritone 3/4" Single				NA	NA	NA	NA
Linen Weave 3/4"				72" x 36"	72" x 36"	48" x 48"	48" x 48"
Premiere 1/2"				60" x 48"	72" x 36"	48" x 48"	48" x 48"
Premiere 3/4"				72" x 36"	72" x 36"	48" x 48"	48" x 48"
Symphony 3/8"				96" x 48"	72" x 36"	52" x 52"	48" x 48"
Virtuoso 1/2"				NA	NA	NA	NA
Prelude 3/4"	27	44	Max Width & Length	84" x 42"	84" x 42"	42" x 42"	42" x 42"

	Starburst Non-Movable Arch	Starburst Movable Arch	Quarter Round Non-Movable	Quarter Round Movable
More Information On Page	Page 82	Page 82	Page 85	Page 85

* Starburst Movable Arches are available as inside mount only.

** Through our maximum width is 84" and our maximum is 72" on Sunset Arches, there are limitations on some larger sizes due to excessive weight. If the Sunset width exceeds 66", the maximum length is 60". If the Sunset width exceeds 72", the maximum length is 48".

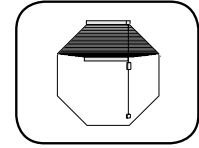
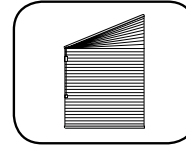
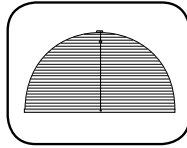

		Sunset Arch	Trapezoid	Octagon
ALL FABRICS (except 3/4" Prelude)	Minimum Width	18"	12"	12"
	Minimum Length	6"	12"	12"
Prelude 3/4"	Minimum Width	18"	12"	8"
	Minimum Length	6"	12"	8"

Light Filtering	Price Group	Page		Sunset Arch	Price Group	Page	Trapezoid	Octagon
Verona 3/4"	28	45	Maximum Width & Length	72" x 60"	32	47	48" x 72"	48" x 48"
Boutique 3/4"				72" x 60"			48" x 72"	48" x 48"
Baritone 3/4"				84" x 72"			48" x 72"	48" x 48"
Debut 1/2" Double				84" x 72"			60" x 72"	48" x 48"
Debut 1/2" Single				84" x 72"			60" x 72"	48" x 48"
Debut 3/4"				84" x 72"			60" x 72"	48" x 48"
Linen Weave 3/4"				72" x 60"			48" x 72"	48" x 48"
Natural Linen Flax				NA			NA	NA
Premiere 1/2"				84" x 72"			60" x 72"	48" x 48"
Premiere 3/4"				84" x 72"			48" x 72"	48" x 48"
Silk Essence 1/2"				84" x 72"			60" x 72"	48" x 48"
Symphony 3/8"				84" x 72"			60" x 72"	48" x 48"
Virtuoso 1/2"			84" x 72"	NA	48" x 48"			
Prelude 3/4"	29	45	Max Width & Length	84" x 48"	33	47	48" x 84"	30" x 30"

Room Darkening & Blackout	Price Group	Page		Sunset Arch	Price Group	Page	Trapezoid	Octagon
Verona 3/4"	30	46	Maximum Width & Length	60" x 60"	34	49	48" x 72"	48" x 48"
Boutique 3/4"				60" x 60"			48" x 72"	48" x 48"
Baritone 3/4" Single				60" x 60"			NA	NA
Linen Weave 3/4"				60" x 60"			48" x 72"	48" x 48"
Premiere 1/2"				60" x 60"			48" x 72"	48" x 48"
Premiere 3/4"				60" x 60"			48" x 72"	48" x 48"
Symphony 3/8"				NA			60" x 72"	48" x 48"
Virtuoso 1/2"				60" x 60"			NA	NA
Prelude 3/4"	31	46	Max Width & Length	84" x 48"	35	49	48" x 84"	30" x 30"

	Sunset Arch	Trapezoid	Octagon
More Information On Page	Page 83	Page 87	Page 87

*Starburst Movable Arches are available as inside mount only.

**Through our maximum width is 84" and our maximum is 72" on Sunset Arches, there are limitations on some larger sizes due to excessive weight. If the Sunset width exceeds 66", the maximum length is 60". If the Sunset width exceeds 72", the maximum length is 48".

LIGHT FILTERING FABRICS

Baritone 3/4"

Boutique 3/4"

Debut 1/2" Single Cell

Debut 1/2" Double Cell

Debut 3/4" Single Cell

Linen Weave 3/4"

Natural Linen Flax 3/4"

Premiere 1/2"

Premiere 3/4"

Silk Essence 1/2"

Symphony 3/8"

Verona 3/4"

Virtuoso 1/2"

**Price Group 24
Starburst Arches
Quarter Rounds**

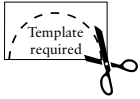

For widths wider than 58"

Width In Inches

	24	30	36	42	48	54	60	66	72	78	84	90	96
Non-Movable Starburst	240	273	311	354	425	486	549	620	698	781	868	963	1070
Movable Starburst	341	386	440	497	595	666	750	839	937				
Non-Movable Quarter Rounds	311	354	404	461	524	597							
Movable Quarter Rounds	425	482	547	618	698								

Product Information: All fabrics are not available in all widths, lengths and hardware options. Refer to Size Specifications on page 41 and 42 for availability. See pages 82 and 85-86 for detailed information. Templates required on non-perfect non-movable Starburst Arches and Quarter Rounds. Movable Starburst Arch shades are for inside and shallow mount applications only.

Prelude 3/4" Light Filtering

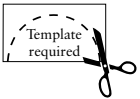

For widths wider than 58"

**Price Group 25
Starburst Arches
Quarter Rounds**

Width In Inches

	24	30	36	42	48	54	60	66	72	78	84
Stationary Starburst	216	246	280	319	383	438	495	558	629	703	782
Movable Starburst	307	348	396	448	536	600	675	756	844	929	1022
Stationary Quarter Round	281	320	364	415							
Movable Quarter Round	Not Available										

FABRIC SURCHARGES		ADD
Scotchgard Stain Protector		\$35
Debut 1/2" Single Cell Print Fabric	Includes: Homespun, Country Woven, Florance, Strata, Angel Hair, Blossom, Terrazzo and Strie	20%
Debut 1/2" Double Cell Print Fabric Debut 3/4" Single Cell Print Fabric	Includes: Homespun, Country Woven, Florance, Strata and Angel Hair	20%
Premiere Fabric	Includes: Homespun, Country Woven, Florance, Spheres, Strata, Tuscan Scroll, Angel Hair, Blossom, and Gradients	20%
Symphony Fabric	Symphony Prints and Duotones	20%
	Symphony Double Cell Flame Resistant	30%
PRICING INFORMATION		
Starburst Arches	Price according to the largest radius measurement. If the height is greater than the width, take height X 2 and use that number to determine pricing. Metallic rails available.	
Quarter Rounds	Price according to the largest radius measurement.	
HARDWARE UPGRADE SURCHARGES* AND ACCESSORIES		ADD
6 Foot Expandable Pole		\$37
12 Foot Expandable Pole		\$46

ROOM DARKENING & BLACKOUT FABRICS

Boutique 3/4"
Linen Weave 3/4"

Premiere 1/2"
Premiere 3/4"

Symphony 3/8"
Verona 3/4"

Price Group 26
Starburst Arches
Quarter Round

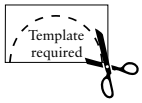

For widths wider than 58"

	Width In Inches												
	24	30	36	42	48	54	60	66	72	78	84	90	96
Non-Movable Starburst	312	355	404	460	553	632	714	806	907	1015	1128	1252	1391
Movable Starburst	443	502	572	646	774	866	975	1091	1218				
Non-Movable Quarter Rounds	404	460	525	599	681	776							
Movable Quarter Rounds	553	627	711	803	907								

Product Information: All fabrics are not available in all widths, lengths and hardware options. Refer to Size Specifications on page 41 and 42 for availability. See pages 82 and 85-86 for detailed information. Templates required on non-perfect non-movable Starburst Arches and Quarter Rounds. Movable Starburst Arch shades are for inside and shallow mount applications only.

Prelude 3/4" Blackout

Price Group 27
Starburst Arches
Quarter Rounds

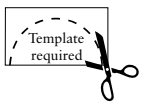

For widths wider than 58"

	Width In Inches												
	24	30	36	42	48	54	60	66	72	78	84		
Stationary Starburst	292	333	378	431	518	592	669	754	850	950	1056		
Movable Starburst	415	470	535	605	724	810	912	1021	1140	1255	1380		
Stationary Quarter Round	380	432	492	561									
Movable Quarter Round	Not Available												

Product Information: See pages 112 and 115 for detailed information. Templates required on non-perfect non-movable Starburst Arches and Quarter Rounds. Movable Starburst Arch shades are for inside and shallow mount applications only.

FABRIC SURCHARGES		ADD
Scotchgard Stain Protector		\$35
Premiere Fabric	Includes: Homespun, Country Woven, Florance, Spheres, Strata, Tuscan Scroll, Angel Hair, Blossom, and Gradients	20%
PRICING INFORMATION		
Starburst Arches	Price according to the largest radius measurement. If the height is greater than the width, take height X 2 and use that number to determine pricing. Metallic rails available.	
Quarter Rounds	Price according to the largest radius measurement.	
HARDWARE UPGRADE SURCHARGES* AND ACCESSORIES		ADD
6 Foot Expandable Pole		\$37
12 Foot Expandable Pole		\$46

Please note: On the Stationary Starburst Arches when the fabric wrapped hardware is selected, the fabric wrap will be spliced in the center of the base rail.

LIGHT FILTERING

Baritone 3/4"

Boutique 3/4"

Debut 1/2" Single Cell

Debut 1/2" Double Cell

Debut 3/4" Single Cell

Linen Weave 3/4"

Premiere 1/2"

Premiere 3/4"

Silk Essence 1/2"

Symphony 3/8"

Verona 3/4"

Virtuoso 1/2"

**Price Group 28
Sunset Movable Arches**

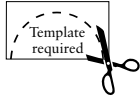

For widths wider than 58"

		Width In Inches										
		24	30	36	42	48	54	60	66	72	78	84
Length In Inches	Half Round	312	347	368	414	442	496	526	579	633	684	754
	36	404	443	464	497	519	557	574	604	633	661	686
	42	426	471	490	540	558	601	621	657	686	722	754
	48	452	497	524	572	594	629	668	704	742	779	821
	60	495	557	584	646	675	733	763	808	852		
72	543	611	648	718	754	823	863	912				

Product Information: All fabrics are not available in all widths, lengths and hardware options. Refer to Size Specifications on page 42 for availability. See pages 83-84 for detailed information. Templates required on non-perfect Sunset Arches.

Prelude 3/4" Light Filtering

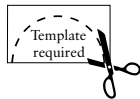

For widths wider than 58"

**Price Group 29
Sunset Movable Arches**

		Width In Inches										
		24	30	36	42	48	54	60	66	72	78	84
Length In Inches	Half Round	281	313	332	373	398	447	474	522	570	616	679
	36	364	399	418	448	468	502	517	544	570	595	618
	42	384	424	441	486	503	541	559	592	618	650	679
	48	407	448	472	515	535	567	602	634	668	702	739

FABRIC SURCHARGES		ADD
Scotchgard Stain Protector		\$35
Debut 1/2" Single Cell Print Fabric	Includes: Homespun, Country Woven, Florance, Strata, Angel Hair, Blossom, Terrazzo and Strie	20%
Debut 1/2" Double Cell Print Fabric Debut 3/4" Single Cell Print Fabric	Includes: Homespun, Country Woven, Florance, Strata and Angel Hair	20%
Premiere Fabric	Includes: Homespun, Country Woven, Florance, Spheres, Strata, Tuscan Scroll, Angel Hair, Blossom, and Gradients	20%
Symphony Fabric	Symphony Prints and Duotones	20%
	Symphony Double Cell Flame Resistant	30%
HARDWARE UPGRADE SURCHARGES AND ACCESSORIES		ADD
6 Foot Expandable Pole		\$37
12 Foot Expandable Pole		\$46

ROOM DARKENING & BLACKOUT FABRICS

Baritone 3/4"
 Boutique 3/4"
 Linen Weave 3/4"

Premiere 1/2"
 Premiere 3/4"
 Verona 3/4"

Virtuoso 1/2"

Price Group 30 Sunset Movable Arches

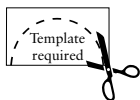

For widths wider than 58"

		Width In Inches						
		24	30	36	42	48	54	60
Length In Inches	Half Round	406	451	478	538	575	645	684
	36	525	576	603	646	675	724	746
	42	554	612	637	702	725	781	807
	48	588	646	681	744	772	818	868
	60	644	724	759	840	878	953	992

Product Information: All fabrics are not available in all widths, lengths and hardware options. Refer to Size Specifications on page 42 for availability. See pages 83-84 for detailed information. Templates required on non-perfect Sunset Arches.

Prelude 3/4" Blackout

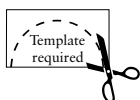

For widths wider than 58"

Price Group 31 Sunset Movable Arches

		Width In Inches										
		24	30	36	42	48	54	60	66	72	78	84
Length In Inches	Half Round	380	423	449	504	538	604	640	705	770	832	917
	36	492	539	565	605	632	678	698	735	770	804	835
	42	519	573	596	657	680	731	755	800	835	878	917
	48	550	605	638	696	723	766	813	856	902	948	998

Product Information: See pages 113-114 for detailed information. Templates required on non-perfect Sunset Arches.

FABRIC SURCHARGES		ADD
Scotchgard Stain Protector		\$35
Premiere Fabric	Includes: Homespun, Country Woven, Florance, Spheres, Strata, Tuscan Scroll, Angel Hair, Blossom, and Gradients	20%
HARDWARE UPGRADE SURCHARGES AND ACCESSORIES		ADD
6 Foot Expandable Pole		\$37
12 Foot Expandable Pole		\$46

LIGHT FILTERING

Baritone 3/4"
 Boutique 3/4"
 Debut 1/2" Single Cell
 Debut 1/2" Double Cell

Debut 3/4" Single Cell
 Linen Weave 3/4"
 Premiere 1/2"
 Premiere 3/4"

Silk Essence 1/2"
 Symphony 3/8"
 Verona 3/4"
 Virtuoso 1/2"*

Price Group 32
Trapezoids and Octagons

		Width In Inches						
		24	30	36	42	48	54	60
Length In Inches	36	430	457	488	523	553	582	611
	42	446	477	512	549	582	616	652
	48	460	496	537	576	611	649	688
	54	476	514	558	600	640	683	723
	60	492	534	581	626	669	719	763
	66	508	553	604	653	702	752	797
	72	523	571	626	680	733	785	839

All fabrics are not available in all widths, lengths and applications. Refer to Size Specifications on page 42 for availability. **Product Information:** See pages 87-88 for detailed information. Width, length and one side are required measurements for Octagon Shades. **Trapezoid orders must be emailed in with a diagram that includes the measurements for 4 sides.** No templates are required for Trapezoid Shades. * Virtuoso fabrics are available as Octagons only.

Prelude 3/4" Light Filtering

Price Group 33
Trapezoids and Octagons

		Width In Inches						
		24	30	36	42	48	54	60
Length In Inches	36	387	412	440	471	498	524	550
	42	402	430	461	495	524	555	587
	48	414	447	484	519	550	585	620
	54	429	463	503	540	576	615	651
	60	443	481	523	564	603	648	687
	66	458	498	544	588	632	677	718
	72	471	514	564	612	660	707	756

Product Information: See page 116-117 for detailed information. Templates required on all Octagon orders.

FABRIC SURCHARGES		ADD
Scotchgard Stain Protector		\$35
Debut 1/2" Single Cell Print Fabric	Includes: Homespun, Country Woven, Florance, Strata, Angel Hair, Blossom, Terrazzo and Strie	20%
Debut 1/2" Double Cell Print Fabric Debut 3/4" Single Cell Print Fabric	Includes: Homespun, Country Woven, Florance, Strata and Angel Hair	20%
Premiere Fabric	Includes: Homespun, Country Woven, Florance, Spheres, Strata, Tuscan Scroll, Angel Hair, Blossom, and Gradients	20%
Symphony Fabric	Symphony Prints and Duotones	20%
	Symphony Double Cell Flame Resistant	30%
HARDWARE UPGRADE SURCHARGES AND ACCESSORIES		ADD
6 Foot Expandable Pole		\$37
12 Foot Expandable Pole		\$46

ROOM DARKENING & BLACKOUT FABRICS

Boutique 3/4"
Linen Weave 3/4"

Premiere 1/2"
Premiere 3/4"

Symphony 3/8"
Verona 3/4"

**Price Group 34
Trapezoids and Octagons**

	Width In Inches							
	24	30	36	42	48	54	60	
Length In Inches	36	559	594	634	680	719	757	794
42	580	620	666	714	757	801	848	
48	598	645	698	749	794	844	894	
54	619	668	725	780	832	888	940	
60	640	694	755	814	870	935	992	
66	660	719	785	849	913	978	1036	
72	680	742	814	884	953	1021	1091	

All fabrics are not available in all widths, lengths and applications. Refer to Size Specifications on page 42 for availability. Product Information: See page 87-88 for detailed information. Templates required on all Octagon orders. Width, length and one side are required measurements for Octagon Shades. Trapezoid orders must be faxed in with a diagram that includes the measurements for 4 sides. No templates are required for Trapezoid Shades.

Prelude 3/4" Blackout

**Price Group 35
Trapezoids and Octagons**

	Width In Inches							
	24	30	36	42	48	54	60	
Length In Inches	36	523	557	594	636	673	708	743
42	543	581	623	669	708	750	793	
48	559	604	654	701	743	790	837	
54	580	626	680	729	778	831	879	
60	599	650	707	762	815	875	928	
66	619	673	735	794	854	914	970	
72	636	694	762	827	891	955	1021	

Product Information: See page 116-117 for detailed information. Templates required on all Octagon orders. Width, length and one side are required measurements for Octagon Shades. Trapezoid orders must be faxed in with a diagram that includes the measurements for 4 sides. No templates are required for Trapezoid Shades.

FABRIC SURCHARGES		ADD
Scotchgard Stain Protector		\$35
Premiere Fabric	Includes: Homespun, Country Woven, Florance, Spheres, Strata, Tuscan Scroll, Angel Hair, Blossom, and Gradients	20%
HARDWARE UPGRADE SURCHARGES AND ACCESSORIES		ADD
6 Foot Expandable Pole		\$37
12 Foot Expandable Pole		\$46

Comfortex Skylight and Greenhouse Shades Size Standards

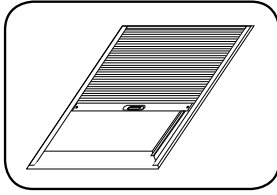

	Minimum	Balcony* 0°-15° 15°-75° 75°-90°**	Soprano*** Skylight/Greenhouse	Mezzo	Pleated Skylight****
ALL FABRICS (except ¼" Prelude)	Min Width	15"	11"	18"	12"
	Min Length	12"	11"	12"	12"
Prelude ¼"	Min Width	18"			
	Min Length	12"			

Light Filtering		Price Group Page	Balcony			Soprano Skylight/ Greenhouse	Price Group Page	Mezzo	Price Group Page	Pleated Skylight	Price Group Page
			0°-15°	15°-75°	75°-90°						
Verona ¼"	Max Width & Length	Grid 37 Page 51	NA	NA	NA	NA	Grid 36 Page 50	48" x 72"	Grid 39 Page 53	NA	Grid 43 Page 56
Boutique ¼"			NA	NA	NA	NA		48" x 72"		NA	
Baritone ¼"			NA	NA	NA	NA		48" x 72"		NA	
Debut ½" Double			NA	NA	NA	NA		48" x 72"		NA	
Debut ½" Single			36" x 96"	48" x 96"	48" x 72"	36" x 144" SL 29" x 180" GH		48" x 72"		NA	
Debut ¾"			NA	NA	NA	NA		48" x 72"		NA	
Linen Weave ¾"			NA	NA	NA	NA		48" x 72"		NA	
Premiere ½"			NA	NA	NA	NA		48" x 72"		NA	
Premiere ¾"			NA	NA	NA	NA		48" x 72"		NA	
Silk Essence ½"			36" x 96"	48" x 96"	48" x 72"	36" x 144" SL 29" x 180" GH		48" x 72"		NA	
Symphony ¾"			36" x 96"	48" x 96"	48" x 72"	48" x 144" SL 36" x 180" GH		48" x 72"		NA	
Virtuoso ½"			36" x 96"	48" x 96"	48" x 72"	36" x 144" SL 29" x 180" GH		48" x 72"		NA	
Prelude ¼"	Max Width & Length	41 Pg55	60" x 72" 25 sqft								
Privada Pleated			43 Pg56	NA	NA	NA	NA	NA	36" x 72"		

Room Darkening & Blackout		Price Group Page	Balcony			Soprano Skylight/ Greenhouse	Price Group Page	Mezzo	Price Group Page	Pleated Skylight	Grid Page
			0°-15°	15°-75°	75°-90°						
Verona ¼"	Max Width & Length	Grid 38 Page 52	NA	NA	NA	NA	Grid 36 Page 50	48" x 72"	Grid 40 Page 54	NA	NA
Boutique ¼"			NA	NA	NA	NA		48" x 72"		NA	
Baritone ¼" Single			NA	NA	NA	NA		48" x 72"		NA	
Linen Weave ¾"			NA	NA	NA	NA		48" x 72"		NA	
Premiere ½"			NA	NA	NA	NA		48" x 72"		NA	
Premiere ¾"			NA	NA	NA	NA		48" x 72"		NA	
Symphony ¾"			36" x 96"	48" x 96"	48" x 72"	NA		48" x 72"		NA	
Virtuoso ½"			36" x 96"	48" x 96"	48" x 72"	NA		48" x 72"		NA	
Prelude ¼"	Max Width & Length	42 Pg55	60" x 72" 25 sqft								

More Information On Page	Page 91	Page 89	Page 93	Page 96
--------------------------	---------	---------	---------	---------

*Total Balcony shade area not to exceed 24 square feet. **Total Balcony shade area not to exceed 18 square feet. Balcony shades can be mounted on their side. Use vertical measurement as your width (max 36") and the horizontal measurement as your length (max 48"). ***Soprano Skylight minimum installation angle of 5 degrees. Maximum installation angle of 85 degrees. Horizontal (0 degrees) and vertical (90 degrees) applications are not recommended. ***All Soprano Greenhouse shade orders require a completed and signed greenhouse shade order form. Orders must be faxed to Comfortex for processing. Download a copy of the order form at www.comfortexdealers.com. ****Total Privada Skylight Shading Systems shade are not to exceed 18 square feet.

LIGHT FILTERING FABRICS

- Debut 1/2" Single Cell
- Silk Essence 1/2"
- Symphony 3/8"
- Virtuoso 1/2"

**Price Group 36
Soprano Skylights and Greenhouses**

	Width In Inches					
	26	30	34	38	42	48
30	482	514	547	578	610	647
36	521	558	594	629	665	703
42	560	602	640	680	721	762
48	602	647	690	730	773	822
54	640	693	737	781	827	878
60	683	737	784	833	880	936
72	765	821	878	935	991	1056
84	847	911	977	1038	1100	1173
96	932	1000	1071	1140	1211	1294
108	1014	1090	1164	1239	1315	1406
120	1100	1177	1262	1344	1427	1525
132	1179	1268	1357	1446	1536	1640
144	1256	1358	1454	1550	1643	1760
156	1336	1448	1550	1652		
168	1415	1540	1646	1753		
180	1492	1631	1740	1855		

All fabrics are not available in all widths, lengths and applications. Refer to Size Specifications on page 49 for availability. Product Information: See page 89 for detailed information. All greenhouse orders require a completed and signed greenhouse shade order form. Orders must be mailed or faxed to Comfortex for processing. Download a copy at www.comfortexdealers.com or from the OnDemand Mobile Library.

FABRIC SURCHARGES		ADD
Scotchgard Stain Protector		\$35
Debut 1/2" Single Cell Print Fabric	Includes: Honespun, Country Woven, Florance, Strata, Angel Hair, Blossom, Terrazzo and Strie	20%
Symphony Fabric	Symphony Prints and Duotones	20%
	Symphony Double Cell Flame Resistant	30%
HARDWARE UPGRADE SURCHARGES* AND ACCESSORIES		ADD
Two Moving Rails		\$129
6 Foot Expandable Pole		\$37
12 Foot Expandable Pole		\$46

- Rail Colors Available:**
Please specify when ordering
- White head and bottom rail with white geartrack retainer.
 - Bronze head and bottom rails and bronze geartrack retainer.

LIGHT FILTERING FABRICS

- Debut 1/2" Single Cell**
- Silk Essence 1/2"**
- Symphony 3/8"**
- Virtuoso 1/2"**

**Price Group 37
Balcony Skylight Shading System**

		Width In Inches				
		24	30	36	42	48
Length In Inches	36	308	350	391	438	477
	42	325	372	425	471	523
	48	342	400	450	505	561
	54	366	424	481	537	609
	60	378	448	509	571	654
	66	400	469	536	600	696
	72	424	495	559	626	735
	78	448	514	585	654	
	84	473	539	610	680	
	90	504	559	636		
96	528	582	662			

All fabrics are not available in all widths, lengths and applications. Refer to Size Specifications on page 49 for availability.

Product Information: See page 91 for detailed information.

- Shades are built with color coordinating hardware and white track.
- Designer metallic and fabric wrapped rails are available.

FABRIC SURCHARGES		ADD
Scotchgard Stain Protector		\$35
Debut 1/2" Single Cell Print Fabric	Includes: Homespun, Country Woven, Florance, Strata, Angel Hair, Blossom, Terrazzo and Strie	20%
Symphony Fabric	Symphony Prints and Duotones	20%
	Symphony Double Cell Flame Resistant	30%
HARDWARE UPGRADE SURCHARGES AND ACCESSORIES		ADD
Metallic Hardware or Fabric Wrapped Rails		\$22
6 Foot Expandable Pole		\$37
12 Foot Expandable Pole		\$46

BLACKOUT FABRICS

Symphony $\frac{3}{8}$ "

Virtuoso $\frac{1}{2}$ "

Price Group 38 Balcony Skylight Shading System

		Width In Inches				
		24	30	36	42	48
Length In Inches	36	400	455	508	569	620
	42	423	484	553	612	680
	48	445	520	585	657	729
	54	476	551	625	698	792
	60	491	582	662	742	850
	66	520	610	697	780	905
	72	551	644	727	814	956
	78	582	668	761	850	
	84	615	701	793	884	
	90	655	727	827		
96	686	757	861			

Product Information: See page 91 for detailed information.

- Shades are built with color coordinating hardware and white track.
- Designer metallic and fabric wrapped rails are available.

FABRIC SURCHARGES		ADD
Scotchgard Stain Protector		\$35
Debut $\frac{1}{2}$ " Single Cell Print Fabric	Includes: Homespun, Country Woven, Florance, Strata, Angel Hair, Blossom, Terrazzo and Strie	Add 20%
Symphony Fabric	Symphony Prints and Duotones	Add 20%
	Symphony Double Cell Flame Resistant	Add 30%
HARDWARE UPGRADE SURCHARGES AND ACCESSORIES		ADD
Metallic Hardware or Fabric Wrapped Rails		\$22
6 Foot Expandable Pole		\$37
12 Foot Expandable Pole		\$46

LIGHT FILTERING FABRICS

Baritone 3/4"
 Boutique 3/4"
 Debut 1/2" Single Cell
 Debut 1/2" Double Cell

Debut 3/4" Single Cell
 Linen Weave 3/4"
 Premiere 1/2"
 Premiere 3/4"

Silk Essence 1/2"
 Symphony 3/8"
 Verona 3/4"
 Virtuoso 1/2"

Price Group 39

Mezzo Motorized Skylights - White Rail and White Tracks

Width In Inches

	24	30	36	42	48	
Length In Inches	36	384	437	488	548	596
	42	407	465	530	588	655
	48	429	500	563	630	702
	54	456	529	601	671	760
	60	473	559	635	714	816
	66	500	585	668	751	870
	72	529	620	698	781	919

Be sure to add the Simplicity motor surcharges and upgrades to the grid above. Shades and motors are priced separately to ensure that percent surcharges apply only to the shade and not the motor.

Product Information: See page 93 for detailed information.

- Mezzo Shades are built with white rail and white track.

FABRIC SURCHARGES		ADD
Scotchgard Stain Protector		\$35
Debut 1/2" Single Cell Print Fabric	Includes: Homespun, Country Woven, Florance, Strata, Angel Hair, Blossom, Terrazzo and Strie	20%
Debut 1/2" Double Cell Print Fabric Debut 3/4" Single Cell Print Fabric	Includes: Homespun, Country Woven, Florance, Strata and Angel Hair	20%
Premiere Fabric	Includes: Homespun, Country Woven, Florance, Spheres, Strata, Tuscan Scroll, Angel Hair, Blossom, and Gradients	20%
Symphony Fabric	Symphony Prints and Duotones	20%
	Symphony Double Cell Flame Resistant	30%
MOTORIZATION - HARDWARE UPGRADE SURCHARGES AND ACCESSORIES		MORE INFO
Simplicity - Motor and Battery Wand		Pg 70
Simplicity 5 Channel Remote		Pg 70
Simplicity 6 Channel Remote with Timer		Pg 70
48" Extension Wire:		Pg 70
Simplicity Smart Controller (NEO)		Pg 75
Solar Panel Recharge Kit : Includes Solar Panel with brackets, rechargeable battery wand with clips and Y cable		Pg 94
Plug In Charger: for rechargeable battery wand in Solar Recharge Kit		Pg 94
		ADD
		\$334
		\$40
		\$65
		\$18
		\$330
		\$173
		\$54

ROOM DARKENING & BLACKOUT FABRICS

Baritone 3/4"
 Boutique 3/4"
 Linen Weave 3/4"

Premiere 1/2"
 Premiere 3/4"
 Symphony 3/8"

Verona 3/4"
 Virtuoso 1/2"

Price Group 40

Mezzo Motorized Skylights - White Rail and White Tracks

		Width In Inches				
		24	30	36	42	48
Length In Inches	36	499	568	634	712	775
	42	529	605	689	764	852
	48	558	650	732	819	913
	54	593	688	781	872	988
	60	615	727	826	928	1061
	66	650	761	868	976	1131
	72	688	806	907	1015	1195

Be sure to add the Simplicity motor surcharges and upgrades to the grid above.

Product Information: See page 93 for detailed information.

- Mezzo Shades are built with white rail and white track.

FABRIC SURCHARGES		ADD
Scotchgard Stain Protector		\$35
Premiere Fabric	Includes: Homespun, Country Woven, Florance, Spheres, Strata, Tuscan Scroll, Angel Hair, Blossom, and Gradients	Add 20%
MOTORIZATION - HARDWARE UPGRADE SURCHARGES AND ACCESSORIES		MORE INFO
		ADD
Simplicity - Motor and Battery Wand		Pg 70 \$334
Simplicity 5 Channel Remote		Pg 70 \$40
Simplicity 6 Channel Remote with Timer		Pg 70 \$65
48" Extension Wire:		Pg 70 \$18
Simplicity Smart Controller (NEO)		Pg 75 \$330
Solar Panel Recharge Kit : Includes Solar Panel with brackets, rechargeable battery wand with clips and Y cable		Pg 94 \$173
Plug In Charger: for rechargeable battery wand in Solar Recharge Kit		Pg 94 \$54

Prelude 3/4" Light Filtering

**Price Group 41
Skylight Shading System**

		Width In Inches						
		24	30	36	42	48	54	60
Length In Inches	36	278	315	352	395	430	495	570
	42	293	335	383	424	471	542	624
	48	308	360	405	455	505	581	669
	54	330	382	433	484	549	632	727
	60	341	404	459	514	589	678	780
	66	360	423	483	540	627	722	831
	72	382	446	504	564	662	762	877

Prelude 3/4" Blackout

**Price Group 42
Skylight Shading System**

		Width In Inches						
		24	30	36	42	48	54	60
Length In Inches	36	376	426	476	534	581	669	770
	42	396	453	518	573	636	732	843
	48	416	486	547	615	682	785	904
	54	446	516	585	654	742	854	982
	60	461	546	620	694	796	916	1053
	66	486	572	653	729	847	975	1122
	72	516	603	681	762	894	1029	1184

Product Information: See page 118 for detailed information.

HARDWARE UPGRADE SURCHARGES AND ACCESSORIES		ADD
5 Foot Expandable Pole		\$37

Privada Privacy Pleated Light Filtering

**Price Group 43
Skylight Shading System - Off-White Rails**

Specialty Shaped Shades

		Width In Inches		
		24	30	36
Length In Inches	36	262	298	333
	42	277	317	362
	48	291	340	383
	54	312	361	409
	60	322	381	433
	66	340	399	456
	72	361	421	476

Size Specifications: See page 49.

Product Information: See page 96 for detailed information. Privada Skylight Shading System shades will have off-white cord with off-white rails (standard).

FABRIC SURCHARGES		ADD
Strie Light Filtering		20%
Linen		30%
HARDWARE UPGRADE SURCHARGES* AND ACCESSORIES		ADD
6 Foot Expandable Pole		\$37
12 Foot Expandable Pole		\$46

Bottom Rail Gap

The handle creates a gap between the moving rail and the stationary bottom rails on Privada Skylight Shading Systems. To minimize this gap, white fuzz bar is applied to the moving and bottom rail.



French Door Décor Shades Size Standards

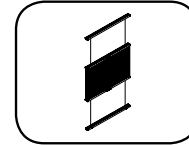
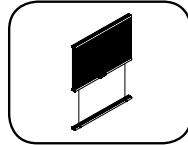
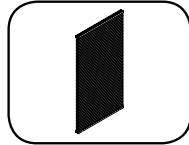

		Door Decor Non-Movable	Door Decor Movable		Door Decor Top Down-Bottom Up
ALL FABRICS	Minimum Width	6"	6"		6"
	Minimum Length	12"	12"		12"

Light Filtering	Price Group	Page		Door Decor Non-Movable	Door Decor Movable	Price Group Page	Door Decor Top Down-Bottom Up	Price Group Page
Verona 3/4"	44	58	Maximum Width & Length	36" x 96"	36" x 96"	45 Page 59	36" x 96"	45 Page 59
Boutique 3/4"				36" x 96"	36" x 96"		36" x 96"	
Baritone 3/4"				36" x 96"	36" x 96"		36" x 96"	
Debut 1/2" Single				36" x 96"	36" x 96"		36" x 96"	
Debut 1/2" Double				36" x 96"	36" x 96"		36" x 96"	
Debut 3/4"				36" x 96"	36" x 96"		36" x 96"	
Linen Weave 3/4"				36" x 96"	36" x 96"		36" x 96"	
Natural Linen Flax				36" x 96"	36" x 96"		36" x 96"	
Premiere 1/2"				36" x 96"	36" x 96"		36" x 96"	
Premiere 3/4"				36" x 96"	36" x 96"		36" x 96"	
Silk Essence 1/2"				36" x 96"	36" x 96"		36" x 96"	
Symphony 3/8"				36" x 96"	36" x 96"		36" x 96"	
Virtuoso 1/2"	36" x 96"	36" x 96"	36" x 96"					

Room Darkening & Blackout	Price Group Page	Page		Door Decor Non-Movable	Door Decor Movable	Price Group Page	Door Decor Top Down-Bottom Up	Price Group Page
Verona 3/4"	46	60	Maximum Width & Length	36" x 96"	36" x 96"	47 Page 61	36" x 96"	47 Page 61
Boutique 3/4"				36" x 96"	36" x 96"		36" x 96"	
Baritone 3/4"				36" x 96"	36" x 96"		36" x 96"	
Linen Weave 3/4"				36" x 96"	36" x 96"		36" x 96"	
Premiere 1/2"				36" x 96"	36" x 96"		36" x 96"	
Premiere 3/4"				36" x 96"	36" x 96"		36" x 96"	
Symphony 3/8"				36" x 96"	36" x 96"		36" x 96"	
Virtuoso 1/2"				36" x 96"	36" x 96"		36" x 96"	

	Door Decor Non-Movable	Door Decor Movable	Door Decor Top Down-Bottom Up
More Information On Page	Page 97	Page 97	Page 97

LIGHT FILTERING FABRICS

Baritone 3/4"
 Boutique 3/4"
 Debut 1/2" Single Cell
 Debut 1/2" Double Cell
 Debut 3/4" Single Cell

Linen Weave 3/4"
 Natural Linen Flax 3/4"
 Premiere 1/2"
 Premiere 3/4"
 Silk Essence 1/2"

Symphony 3/8"
 Verona 3/4"
 Virtuoso 1/2"

**Price Group 44
 Non-Movable French Door Décor**

		Width In Inches		
		24	30	36
Length In Inches	36	98	111	126
	42	105	120	135
	48	112	129	147
	54	118	136	158
	60	127	146	168
	66	134	156	180
	72	140	163	190
	78	147	172	199
	84	153	181	209
	90	160	189	219
96	165	196	229	

Product Information: See page 97 for detailed information.

FABRIC SURCHARGES		ADD
Scotchgard Stain Protector		\$35
Debut 1/2" Single Cell Print Fabric	Includes: Honespun, Country Woven, Florance, Strata, Angel Hair, Blossom, Terrazzo and Strie	20%
Premiere Fabric	Includes: Honespun, Country Woven, Florance, Spheres, Strata, Tuscan Scroll, Angel Hair, Blossom, and Gradients	20%
Symphony Fabric	Symphony Prints and Duotones	20%
	Symphony Double Cell Flame Resistant	30%
HARDWARE UPGRADE SURCHARGES AND ACCESSORIES		ADD
Metallic Hardware or Fabric Wrapped Rails		\$22
6 Foot Expandable Pole		\$37
12 Foot Expandable Pole		\$46

LIGHT FILTERING FABRICS

Baritone 3/4"
 Boutique 3/4"
 Debut 1/2" Single Cell
 Debut 1/2" Double Cell
 Debut 3/4" Single Cell

Linen Weave 3/4"
 Natural Linen Flax 3/4"
 Premiere 1/2"
 Premiere 3/4"
 Silk Essence 1/2"

Symphony 3/8"
 Verona 3/4"
 Virtuoso 1/2"

**Price Group 45
 Movable French Door Décor**

		Width In Inches		
		24	30	36
Length In Inches	36	176	199	227
	42	190	216	245
	48	201	232	265
	54	214	247	284
	60	229	263	305
	66	242	280	324
	72	254	295	342
	78	265	312	360
	84	275	325	377
	90	289	340	396
96	299	353	412	

Product Information: See page 97 for detailed information.

FABRIC SURCHARGES		ADD
Scotchgard Stain Protector		\$35
Debut 1/2" Single Cell Print Fabric	Includes: Homespun, Country Woven, Florance, Strata, Angel Hair, Blossom, Terrazzo and Strie	20%
Premiere Fabric	Includes: Homespun, Country Woven, Florance, Spheres, Strata, Tuscan Scroll, Angel Hair, Blossom, and Gradients	20%
Symphony Fabric	Symphony Prints and Duotones	20%
	Symphony Double Cell Flame Resistant	30%
HARDWARE UPGRADE SURCHARGES AND ACCESSORIES		ADD
Top Down-Bottom Up		\$166
Metallic Hardware or Fabric Wrapped Rails		\$22
6 Foot Expandable Pole		\$37
12 Foot Expandable Pole		\$46

ROOM DARKENING & BLACKOUT FABRICS

Baritone 3/4"
 Boutique 3/4"
 Linen Weave 3/4"

Premiere 1/2"
 Premiere 3/4"
 Symphony 3/8"

Verona 3/4"
 Virtuoso 1/2"

**Price Group 46
 Non-Movable French Door Décor**

		Width In Inches		
		24	30	36
Length In Inches	36	127	144	164
	42	137	156	176
	48	146	168	191
	54	153	177	205
	60	165	190	218
	66	174	203	234
	72	182	212	247
	78	191	224	259
	84	199	235	272
	90	208	246	285
96	215	255	298	

Product Information: See page 97 for detailed information.

FABRIC SURCHARGES		ADD
Scotchgard Stain Protector		\$35
Premiere Fabric	Includes: Homespun, Country Woven, Florance, Spheres, Strata, Tuscan Scroll, Angel Hair, Blossom, and Gradients	20%
Symphony Fabric	Symphony Prints and Duotones	20%
	Symphony Double Cell Flame Resistant	30%
HARDWARE UPGRADE SURCHARGES AND ACCESSORIES		ADD
Metallic Hardware or Fabric Wrapped Rails		\$22
6 Foot Expandable Pole		\$37
12 Foot Expandable Pole		\$46

ROOM DARKENING & BLACKOUT FABRICS

Baritone 3/4"
 Boutique 3/4"
 Linen Weave 3/4"

Premiere 1/2"
 Premiere 3/4"
 Symphony 3/8"

Verona 3/4"
 Virtuoso 1/2"

**Price Group 47
 Movable French Door Décor**

		Width In Inches		
		24	30	36
Length In Inches	36	229	259	295
	42	247	281	319
	48	261	302	345
	54	278	321	369
	60	298	342	397
	66	315	364	421
	72	330	384	445
	78	345	406	468
	84	358	423	490
	90	376	442	515
96	389	459	536	

Product Information: See page 97 for detailed information.

FABRIC SURCHARGES		ADD
Scotchgard Stain Protector		\$35
Premiere Fabric	Includes: Homespun, Country Woven, Florance, Spheres, Strata, Tuscan Scroll, Angel Hair, Blossom, and Gradients	20%
Symphony Fabric	Symphony Prints and Duotones	20%
	Symphony Double Cell Flame Resistant	30%
HARDWARE UPGRADE SURCHARGES AND ACCESSORIES		ADD
Top Down-Bottom Up		\$166
Metallic Hardware or Fabric Wrapped Rails		\$22
6 Foot Expandable Pole		\$37
12 Foot Expandable Pole		\$46

Cellular Shade Head Rail Options

STANDARD CORD LOCK SHADES | Prelude Hardware Page 102

Hardware

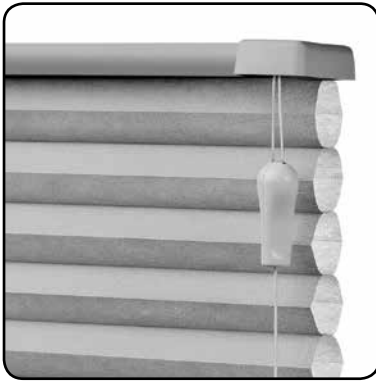

Standard Cord Lock Rail

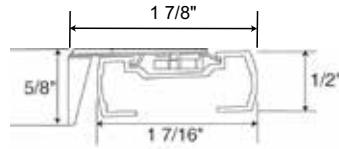

Deluxe Cord Lock Rail

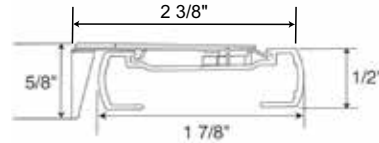

Standard Cord Lock Rail

- Depth of rail: 1 7/16"
- Depth of rail and bracket: 1 7/8"
- Height of rail: 1/2"
- Height of bracket: 5/8"

Deluxe Cord Lock Rail

- Depth of rail: 1 7/8"
- Depth of rail and bracket: 2 3/8"
- Height: 1/2"
- Height of bracket: 5/8"

Hardware Features

Hardware colors for all Cellular and Pleated fabrics	Color coordinated head, middle and bottom rails with white cord and tassel
Standard Hardware for all Custom Graphics	White head, middle and bottom rails with white cord and tassel

Upgrades

Fabric Wrapped Upgrade	Fabric used is same fabric as the shade. Back of rail is white to outside. Color coordinated end caps.
Designer Metallic Upgrade	<ul style="list-style-type: none"> • Oil Rubbed Bronze head and bottom rails with bronze colored tassel, end caps and white cord. • Brushed Nickel head and bottom rails and end caps with coordinating tassel and white cord.

Mounting Dimensions	Standard Cord Lock Rail	Deluxe Cord Lock Rail
Minimum Shallow Mount	3/4"	3/4"
Minimum Flush Inside Mount	2"	2 3/8"
Minimum Outside Mount	3/4"	3/4"
Minimum Side Mount	1 1/8"	1 3/8"
Minimum Flush Side Mount	1 5/8"	1 7/8"
Recommended Side Mounting Method	<ul style="list-style-type: none"> • See figure B for recommended mounting method for side mount shades • Width limit for side mount brackets is 48" 	

Finished Dimensions

Inside and Side Mount	
	<ul style="list-style-type: none"> • Fabric will measure ordered width less: 3/8" • Head rail* will measure ordered width less: 3/16"
Outside Mount	
	<ul style="list-style-type: none"> • Fabric will measure ordered width • Head rail* will measure ordered width plus: 3/16"
Exact (End Cap to End Cap) Mount	
	<ul style="list-style-type: none"> • Fabric will measure ordered width less: 3/16" • Head rail* will measure ordered width

* Head rail measurements include endcaps. Width and length measurements may vary +/- 1/8"

Cellular Shade

STANDARD CORD LOCK SHADES | *Prelude Hardware Page 102*

There are two sizes of the cord lock hardware: **Standard and Deluxe.**

Standard size hardware is used on all fabrics except 3/4" Premiere, Linen Weave, Debut, Baritone, Verona and Boutique Fabrics which use the Deluxe size.

- Standard Rectangular
- Two-On-One Head Rail
- Door Decor
- SlumberShades
- Top Down - Bottom Up
- Day-Night
- Specialty Shapes
- Balcony

Deluxe Hardware is standard on 3/4" Premiere, Linen Weave, Debut, Baritone, Verona and Boutique Fabrics.

- Standard Rectangular
- SlumberShades
- Two-On-One Head Rail
- Top Down - Bottom Up
- Specialty Shapes

Highlights Cornice Valance

Add a designer finishing touch to a cellular shade with a Highlights Cornice Valance. See page 121 for details.

Two-On-One Head Rail with Splicer

- Two-On-One Head Rail shades can also be made using two standard rectangular shades joined by a 6" splicer. (See Figure A below). A retail surcharge does not apply to Two-On-One shades with a splicer.

Two-On-One Headrail with Splicer

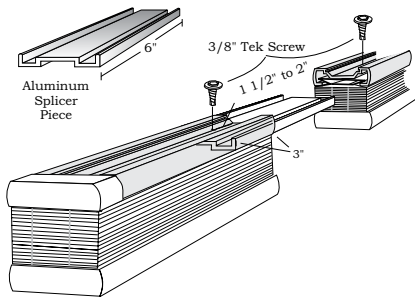

Figure A

Recommended Mounting Method for Side Mount Shades | Maximum Width 48"

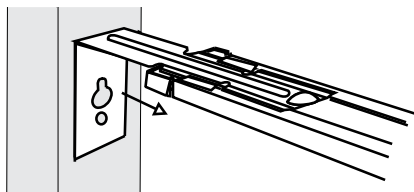

Figure B

EZ Level on Cellular Shades

EZ Level makes quick work of leveling without cords to cut or tuck into a rail. See page 122 for details.

Things to Consider

- If child safety is a concern, consider cordless options: Cordless Ultra, Cordless Lift & Lock or Motorization.
- Larger shades can be difficult to operate. Consider Cord Loop, Cordless Ultra or Motorization hardware.
- If privacy is an issue, consider Top Down-Bottom Up options.

Ordering Information Standard Cord Lock Shades

Standard Rectangular

- Specify IB or OB mount, rail color and left or right lift cord.

Top Down - Bottom Up

- Specify IB or OB mount and rail color. Middle rail will match the head and bottom rails.
- Top Down - Bottom Up Shades are made with two operating cord locks, one on the left and one on the right side of shade. The right cord operates the middle rail and left cord operates the bottom.

Two-On-One Head Rail and Two-On-One Head Rail with Splicer

Two-On-One Head Rail Shades operate as two separate shades on one head rail.

- Specify IB or OB mount.
- Specify panel sizes.
- Maximum width in a single panel depends on fabric type. See page 11 for maximum single panel width.
- 3/8" Space between panels.
- Fabric wrapped Two-On-One Shades will have a seam in the center of the rail due to the wide width.
- Two-On-One Head Rail shades can also be made using two standard rectangular shades joined by a 6" splicer. (See Figure A). A retail surcharge does not apply to Two-On-One shades with a splicer.

Specialties (Arches, Trapezoids, Octagons and Quarter Rounds)

See pages 82-88 for more information.

Balcony Skylight Shading System

See pages 91-92 for more information.

Door Decor

See pages 97-98 for more information.

Insulating SlumberShades

See pages 80-81 for more information.

Day-Night Shades

See pages 99-100 for more information.

Cellular Shade Head Rail Options

CORD LOOP HARDWARE SYSTEM | Prelude Hardware Page 104

Hardware

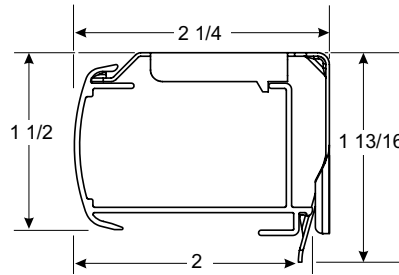

Cord Loop Rail Dimensions

- Depth of rail: 2"
- Depth of rail and bracket: 1 1/4"
- Height of rail: 1 1/2"
- Height of bracket: 1 13/16"

Hardware Features	
Hardware colors for all Cellular and Pleated fabrics	Color coordinated head, middle, bottom rails and end caps with a white cord and tensioner
Standard Hardware for all Custom Graphics	White head, middle and bottom rails with white cord and tassel
Upgrades	
Fabric Wrapped Upgrade	Fabric used is same fabric as the shade. Back of rail is white to outside. Color coordinated end caps for rails, head rail has white end caps
Designer Metallic Upgrade	<ul style="list-style-type: none"> • Smooth faced Oil Rubbed Bronze head, middle, bottom rails and end caps with bronze tensioner and bronze cord. • Smooth faced Brushed Nickel head, middle, bottom rails and end caps with silver tensioner and silver cord.

Mounting Dimensions	Cord Loop Hardware System
Minimum Shallow Mount	1/2"
Minimum Flush Inside Mount	2 1/4"
Minimum Outside Mount	7/8"
Minimum Side Mount	1 1/4"
Minimum Flush Side Mount	2 1/4"
Recommended Side Mounting Method	<ul style="list-style-type: none"> • See figure A for recommended mounting method for side mount shades • Width limit for side mount brackets is 48"

Finished Dimensions	
Inside Mount	
	<ul style="list-style-type: none"> • Fabric will measure ordered width less: 3/8" • Head rail* will measure ordered width less: 3/16"
Outside Mount	
	<ul style="list-style-type: none"> • Fabric will measure ordered width • Head rail* will measure ordered width plus: 3/16"
Side Mount	
	<ul style="list-style-type: none"> • Fabric will measure ordered width less: 7/8" • Head rail* will measure ordered width less: 1 1/16"
Exact (End Cap to End Cap) Mount	
	<ul style="list-style-type: none"> • Fabric will measure ordered width less: 3/16" • Head rail* will measure ordered width

* Head rail measurements include endcaps. Width and length measurements may vary +/- 1/8"

Cellular Shade

CORD LOOP HARDWARE SYSTEM | Prelude Hardware Page 104

Applications

- Standard Rectangular
- Two-On-One Head Rail
- Top Down - Bottom Up
- SlumberShades

Cord Loop Hardware System Features

Cord loops are available 2' to 15' lengths in 1' intervals. Please specify length when ordering. Standard loop sizes are as follows:

Shade Length	Standard Loop
Up to and including 26 ⁷ / ₈ "	1' (12")
27" to 39 ⁷ / ₈ "	2' (24")
40" to 59 ⁷ / ₈ "	3' (36")
60" to 83 ⁷ / ₈ "	4' (48")
84" to 107 ⁷ / ₈ "	5' (60")
108" and greater	6' (72")

Recommended Mounting Method for Side Mounting Shades

Width limit for side mount brackets is 48".

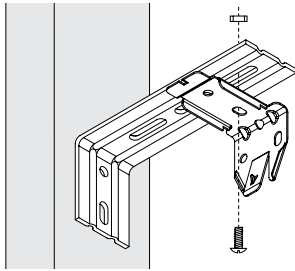

Figure A

Refer to the installation instructions on Comfortexdealers.com or the OnDemand Mobile Library for further details on side mounting shades.

Cord Loop Hardware
Cordless Ultra Hardware
Cordless Ultra Top Down -
Bottom Up Hardware

Ordering Information for Cord Loop Hardware Shades

Standard Rectangular

- Specify IB or OB mount, rail color and left or right lift cord.
- Specify cord loop length when ordering.

Top Down - Bottom Up

- Specify IB or OB mount and rail color. Middle rail will match the top and bottom rails.
- Specify cord loop length when ordering.
- Controls are the right cord loop operates the middle rail and left cord loop operates the bottom. Reverse controls are not available.

Two-On-One Head Rail

- Two-On-One Head Rail Shades operate as two separate shades on one head rail.
- Specify IB or OB mount and rail color.
- Specify panel sizes.
- Specify cord loop length when ordering.
- Maximum width in a single panel depends on fabric type. See page 11 for maximum single panel width.
- ³/₈" Space between panels.
- Fabric wrapped Two-On-One Shades will have a seam in the center of the rail due to the wide width.

Insulating SlumberShades

See pages 80-81 for more information.

EZ Level on Cellular Shades

EZ Level makes quick work of leveling without cords to cut or tuck into a rail. See page 122 for details.

Cellular Shade Head Rail Options

CORDLESS ULTRA HARDWARE SYSTEM | Prelude Hardware Page 106

Hardware

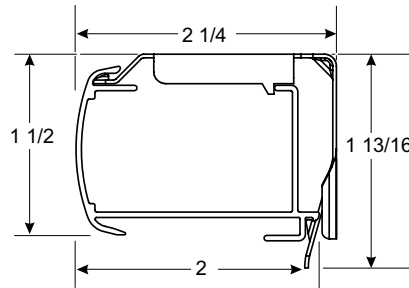

Cord Loop Rail Dimensions

- Depth of rail: 2"
- Depth of rail and bracket: 2 1/4"
- Height of rail: 1 1/2"
- Height of bracket: 1 13/16"

Hardware Features

Hardware colors for all Cellular and Pleated fabrics (Symphony Blackout Not Available)	Color coordinated head, middle, bottom rails and end caps
Standard Hardware for all Custom Graphics	White head, middle and bottom rails and end caps

Upgrades

Fabric Wrapped Upgrade	Fabric used is same fabric as the shade. Back of rail is white to outside. End caps on fabric wrapped head, middle and bottom rails are color coordinated
Designer Metallic Upgrade	<ul style="list-style-type: none"> • Smooth faced Oil Rubbed Bronze head, middle, bottom rails and end caps • Smooth faced Brushed Nickel head, middle, bottom rails and end caps

Mounting Dimensions | **Cord Loop Hardware System**

Minimum Shallow Mount	1/2"
Minimum Flush Inside Mount	2 1/4"
Minimum Outside Mount	7/8"
Minimum Side Mount	1 1/4"
Minimum Flush Side Mount	2 1/4"

Recommended Side Mounting Method	<ul style="list-style-type: none"> • See figure A on page 65 for recommended mounting method for side mount shades • Width limit for side mount brackets is 48"
---	---

Finished Dimensions

Inside Mount

	<ul style="list-style-type: none"> • Fabric will measure ordered width less: 3/8" • Head rail* will measure ordered width less: 3/16"
--	---

Outside Mount

	<ul style="list-style-type: none"> • Fabric will measure ordered width • Head rail* will measure ordered width plus: 3/16"
--	--

Side Mount

	<ul style="list-style-type: none"> • Fabric will measure ordered width less: 7/8" • Head rail* will measure ordered width less: 1 1/16"
--	---

Exact (End Cap to End Cap) Mount

	<ul style="list-style-type: none"> • Fabric will measure ordered width less: 3/16" • Head rail* will measure ordered width
--	--

* Head rail measurements include endcaps. Width and length measurements may vary +/- 1/8"

Cellular Shade

CORDLESS ULTRA HARDWARE SYSTEM | Prelude Hardware Page 106

Applications

- Standard Rectangular
- Top Down - Bottom Up
- Insulating SlumberShades

Highlights Cornice Valance

Add a designer finishing touch to a cellular shade with a Highlights Cornice Valance. See page 121 for details.

Things to Consider

- Is the top of your window out of reach? You can order an extension pole to reach but it can still be tricky. You may want to consider Cord Loop or Motorized hardware.
- For shades mounted on doors, you may want to order hold down brackets.
- If privacy is an issue, consider Top Down-Bottom Up options.

Ordering Information for Cordless Ultra Hardware Shades

Standard Rectangular

- Specify IB or OB mount and rail color.

Top Down - Bottom Up

- Specify IB or OB mount and rail color. Middle rail will match the head and bottom rails.

Insulating SlumberShades

See pages 80-81 for more information.

Accessories

- 6' Expandable Pole: \$37.00
- 12' Expandable Pole: \$46.00

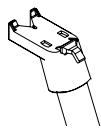

Specially designed pole end fits into the handle on the bottom rail and allows for easy operation.

Cordless Ultra and Cordless Ultra Top Down - Bottom Up Hardware Features

- Children and pets have safer surroundings in homes that have window shades without operating cords, reducing the risk of strangulation.
- Cordless Ultra and Cordless Ultra Top Down - Bottom Up Shades can be raised or lowered with a gentle push or pull on the rail handle.
- Cordless Ultra Top Down - Bottom Up Shades feature two moving rails.
- Order an operating pole for out of reach applications.

Cordless Ultra Shade Operation

Cordless shades should be operated from the handle located in the center of the bottom rail. Using the handle will aid in smooth and easy shade operation. Two handles are supplied on wider width shades.

To lower the shade, pull down on the handle which is secured to the bottom rail and guide the rail to desired position (Figure A). For out of reach applications, an optional extension pole should be used.

To raise the shade, push the bottom rail up using the handle on the bottom rail and guide the rail to the desired position. The shade will hold any position when the bottom rail is released. Raise the shade slowly and steadily to allow the shade to stack evenly (Figure B).

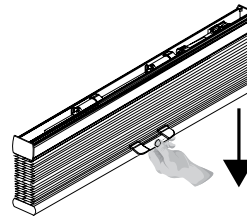

Figure A

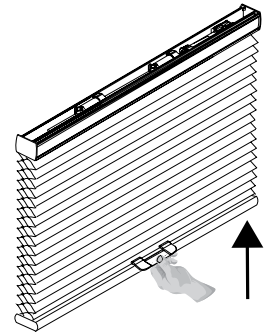

Figure B



Clear Cordless Handle

Recommended Mounting Method for Side Mounting Shades

See Page 65.

EZ Level on Cellular Shades

EZ Level makes quick work of leveling without cords to cut or tuck into a rail. See page 122 for details.

Cellular Shade Head Rail Options

CORDLESS LIFT & LOCK SHADES | Prelude Hardware Page 108

Hardware



Standard Head Rail

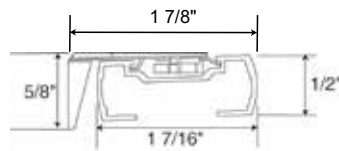

Deluxe Head Rail

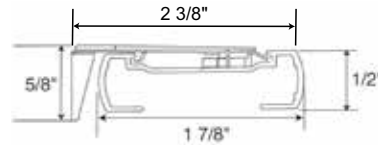

Standard Top Rail

- Depth of rail: 1 7/16"
- Depth of rail and bracket: 1 7/8"
- Height of rail: 1/2"
- Height of bracket: 5/8"

Deluxe Top Rail

- Depth of rail: 1 7/8"
- Depth of rail and bracket: 2 3/8"
- Height: 1/2"
- Height of bracket: 5/8"

Hardware Features

Hardware colors for all Cellular fabrics	Color coordinated head, middle and bottom rails with color coordinated push button/handle on the middle or bottom rails
Standard Hardware for all Custom Graphics	White head, middle and bottom rails with white cord and tassel

Upgrades

Fabric Wrapped Upgrade	Fabric used is same fabric as the shade. Back of rail is white to outside. All shades will have a color coordinated push button and handle on the middle /bottom rail. Color coordinated end caps.
Designer Metallic Upgrade	<ul style="list-style-type: none"> • Oil Rubbed Bronze head, middle, bottom rails and end caps. • Oil Rubbed Bronze push button/handle on the middle or bottom rails.

Mounting Dimensions	Standard Head Rail	Deluxe Head Rail
Minimum Shallow Mount	3/4"	3/4"
Minimum Flush Inside Mount	2"	2 1/2"
Minimum Outside Mount	3/4"	3/4"
Minimum Side Mount	1 1/8"	1 3/8"
Minimum Flush Side Mount	1 5/8"	1 7/8"
Recommended Side Mounting Method	<ul style="list-style-type: none"> • See figure A (pg 65) for recommended mounting method for side mount shades • Width limit for side mount brackets is 48" 	

Finished Dimensions

Inside and Side Mount	
	<ul style="list-style-type: none"> • Fabric will measure ordered width less: 3/8" • Head rail* will measure ordered width less: 3/16"
Outside Mount	
	<ul style="list-style-type: none"> • Fabric will measure ordered width • Head rail* will measure ordered width plus: 3/16"
Exact (End Cap to End Cap) Mount	
	<ul style="list-style-type: none"> • Fabric will measure ordered width less: 3/16" • Head rail* will measure ordered width

* Head rail measurements include endcaps. Width and length measurements may vary +/- 1/8"

Cellular Shade

CORDLESS LIFT & LOCK SHADES | Prelude Hardware Page 108

Cordless Lift & Lock Shades Hardware System Bottom Rail Dimensions

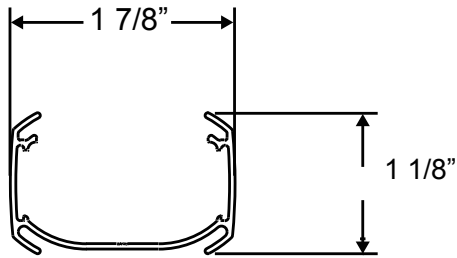

- Depth of rail: 1 7/8"
- Height of rail: 1 1/8"

Applications

- Standard Rectangular
- Top Down-Bottom Up

Standard size head rail hardware is used on 1/2" and 3/8" fabrics. These fabrics include: 1/2" Debut (all), Natural Linen Flax, 1/2" Premiere, Silk Essence, Symphony, Symphony Blackout, Virtuoso, Virtuoso Blackout.

Deluxe size head rail hardware is used on 3/4" Premiere, Linen Weave, Verona, Boutique and 3/4" Debut and Baritone fabrics.

The bottom rail is the same size for all fabrics.

Highlights Cornice Valance

Add a designer finishing touch to a cellular shade with a Highlights Cornice Valance. See page 121 for details.

Important Operating Note on Cordless Lift & Lock Shades

- To operate a Cordless Lift & Lock Shade, the middle or bottom rails must be accessible. An extension pole is not available for Cordless Lift & Lock Shades.

Cordless Lift & Lock Hardware Features

- Children and pets have safer surroundings in homes that have window shades without operating cords, reducing the risk of strangulation.
- Cordless Lift & Lock Shades can be raised or lowered by pressing the button located on the bottom rail and guiding the rail into the desired location.

Leveling the Bottom Rails

Each Cordless Lift & Lock Shade includes a skew adjustment leveling tool hidden in the bottom rail of each shade.

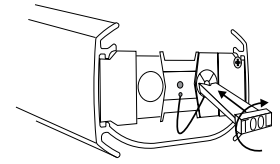

To level the bottom rail, remove the bottom rail end cap to access the tool which allows you to adjust the bottom rail. Adjustment instructions are supplied with each shade.

Things to Consider

- Is the top of your window out of reach? To operate a Cordless Lift & Lock Shade, the bottom rail must be accessible. If the bottom or middle rail is not accessible, you may want to consider Cord Loop, Cordless Ultra or Motorized hardware. An extension pole is not available for Cordless Lift & Lock Shades.
- For shades mounted on doors, you may want to order hold down brackets.

Ordering Information for Cordless Lift & Lock Shades

Standard Rectangular

- Specify IB or OB mount and rail color.

Cordless Lift & Lock Shade Operation

Cordless Lift & Lock Shades are operated using the push button handle located in the center of the bottom rail.

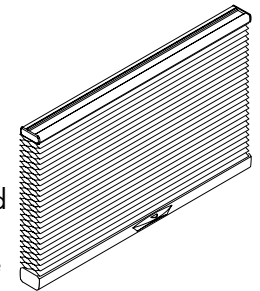

To raise or lower the shade; press the button on the shade handle, and guide the rail to desired position. Release the button to lock the shade into place.

The shade will in hold any position when the button is released. Raise the shade slowly and steadily to allow the shade to stack evenly.

Cellular Shade Head Rail Options

SIMPLICITY MOTORIZED CELLULAR SHADES | *Prelude Hardware Page 119*

Hardware

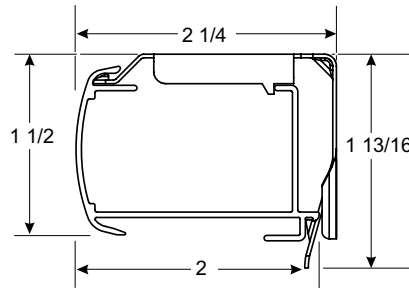

Simplicity Motorized Rail Dimensions

- Depth of rail: 2"
- Depth of rail and bracket: 2 1/4"
- Height of rail: 1 1/2"
- Height of bracket: 1 13/16"

Hardware Features

Hardware colors for all Cellular and Pleated fabrics	Color coordinated head, middle, bottom rails and end caps
Standard Hardware for all Custom Graphics	White head, middle and bottom rails and end caps
Simplicity Remote	Upper and lower limit stops pre-programmed, Intermediate stop "favorites" position can be set on-site.

Upgrades

Fabric Wrapped Upgrade	Fabric used is same fabric as the shade. Back of rail is white to outside. End caps on fabric wrapped head, middle and bottom rails are color coordinated
Designer Metallic Upgrade	<ul style="list-style-type: none"> • Smooth faced Oil Rubbed Bronze head, middle, bottom rails and end caps • Smooth faced Brushed Nickel head, middle, bottom rails and end caps

Mounting Dimensions

Simplicity Motorized Hardware System

Minimum Shallow Mount	1/2"
Minimum Flush Inside Mount	2 1/4"
Minimum Outside Mount	7/8"
Minimum Side Mount	1 1/4"

Recommended Side Mounting Method	<ul style="list-style-type: none"> • See page 65 for recommended mounting method for side mount shades • Width limit for side mount brackets is 48"
---	---

Finished Dimensions

Inside Mount

	<ul style="list-style-type: none"> • Fabric will measure ordered width less: 3/8" • Head rail* will measure ordered width less: 3/16"
--	---

Outside Mount

	<ul style="list-style-type: none"> • Fabric will measure ordered width • Head rail* will measure ordered width plus: 3/16"
--	--

Side Mount

	<ul style="list-style-type: none"> • Fabric will measure ordered width less: 7/8" • Head rail* will measure ordered width less: 1 1/16"
--	---

Exact (End Cap to End Cap) Mount

	<ul style="list-style-type: none"> • Fabric will measure ordered width less: 3/16" • Head rail* will measure ordered width
--	--

* Head rail measurements include endcaps. Width and length measurements may vary +/- 1/8"

Cellular Shade

SIMPLICITY MOTORIZED CELLULAR SHADES | Prelude Hardware Page 119

Simplicity Motors

The Simplicity Motor program features a battery powered motor utilizing a single battery wand or plug-in DC transformer. Simplicity motors are compact and use a radio frequency remote to raise or lower the shades.

Motorized Lift Systems are not offered on sizes within the shaded area on the Standard Rectangular price grids.

- Length measurements may vary +/- 1/8".

Applications

- Standard Rectangular

EZ Level

Learn about the EZ Level feature on page 122.

Simplicity Motorization Surcharges

The standard Simplicity Motorized Lift System surcharge includes a 12 volt battery wand with eight AA batteries. Remotes are needed to operate the shades. See pricing pages.

Important Simplicity Motorized Shade Operating and Installation Information

- Simplicity Motorized Shades installed into windows with metal casings may have a reduced radio frequency range, or may not operate at all, depending on the application.
- Do not let the antenna on the motor touch any metal objects. This may interfere with signals from the remote control.

SIMPLICITY MOTORIZATION PRICING EXAMPLE:	
Natural Linen Flax	
Light Filtering 42" x 60" Shade:	\$350.00
Simplicity Motor Surcharge:	\$334.00
Simplicity Remote Control:	\$40.00
Total List Price:	\$724.00

Simplicity Battery Wand

Batteries are needed to operate Simplicity motors. The battery wand can be clipped to the head rail or wall or ceiling mounted utilizing white battery wand clips. The 12 volt battery wand measures 17 1/4", and comes with eight AA alkaline batteries, and is white in color.

The battery wire is 10" long. A 48" extension wire is available.



Simplicity Motor Battery Life and Replacement

Eight alkaline batteries are included with the wand. The battery life will vary based on the type of window covering selected, the size and weight of the window covering and the number of times you operate the shade on a daily basis. For example, a 36" x 60" single honeycomb shade operated twice daily will commonly have a battery life which lasts up to 18 months.

Comfortex will warranty batteries for up to 3 months from date of purchase.

Simplicity Hand Held Remotes

The 5 Channel remote can operate up to five shades simultaneously, individually or 5 groups. **WHEN ORDERING PLEASE SPECIFY WHICH CHANNELS ARE ASSIGNED TO EACH SHADE OR GROUP OF SHADES.** For example; program line 1 to channel 1, line 2 and 3 to channel 2, etc. If no channels are assigned at time of order, all shades will be programmed to Channel 1. **To reprogram channel assignments, please refer to the installation instructions and/or view the video at comfortexdealers.com/products/motortechsupport.html.**



Simplicity remotes and holders are black or white in color. The remote comes with a holder which can be mounted to a wall for easy storage. The range of the remote is approximately 80 feet.

The Simplicity remote utilizes one 3V battery (CR2032). Batteries are included. Comfortex will warranty batteries for up to 3 months from date of purchase.

A **6 Channel (6C) timer remote** is also available. See page 74 for more information.

DC Power Supply/Transformer

12 Volt DC power supply/transformer is available and requires a standard power outlet to power the motor. The transformer is an alternative to a battery wand. Each transformer can power a single shading. The power supply must plug in to the motor. The DC power supply is white and comes with a 80" wire. The dimensions are 1 7/8" wide x 3 1/4" long x 1 1/4" deep



Cellular Shade Head Rail Options

RECHARGEABLE SIMPLICITY MOTORIZED CELLULAR SHADES

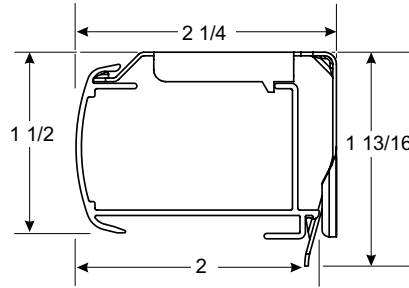

Rechargeable Simplicity Rail Dimensions

- Depth of rail: 2"
- Depth of rail and bracket: 2 1/4"
- Height of rail: 1 1/2"
- Height of bracket: 1 13/16"

Hardware Features	
Hardware colors for all Cellular and Pleated fabrics (Symphony Blackout Not Available)	Color coordinated head, middle, bottom rails and end caps
Standard Hardware for all Custom Graphics	White head, middle and bottom rails and end caps
Upgrades	
Fabric Wrapped Upgrade	Fabric used is same fabric as the shade. Back of rail is white to outside. End caps on fabric wrapped head, middle and bottom rails are color coordinated
Designer Metallic Upgrade	<ul style="list-style-type: none"> • Smooth faced Oil Rubbed Bronze head, middle, bottom rails and end caps • Smooth faced Brushed Nickel head, middle, bottom rails and end caps

Mounting Dimensions	Rechargeable Simplicity Motorization Hardware System
Minimum Shallow Mount	1/2"
Minimum Flush Inside Mount	2 1/4"
Minimum Outside Mount	7/8"
Minimum Side Mount	1 1/4"
Minimum Flush Side Mount	2 1/4"
Recommended Side Mounting Method	<ul style="list-style-type: none"> • See page 65 for recommended mounting method for side mount shades • Width limit for side mount brackets is 48"

Finished Dimensions	
Inside Mount	
	<ul style="list-style-type: none"> • Fabric will measure ordered width less: 3/8" • Head rail* will measure ordered width less: 3/16"
Outside Mount	
	<ul style="list-style-type: none"> • Fabric will measure ordered width • Head rail* will measure ordered width plus: 3/16"
Side Mount	
	<ul style="list-style-type: none"> • Fabric will measure ordered width less: 7/8" • Head rail* will measure ordered width less: 1 1/16"
Exact (End Cap to End Cap) Mount	
	<ul style="list-style-type: none"> • Fabric will measure ordered width less: 3/16" • Head rail* will measure ordered width

* Head rail measurements include endcaps. Width and length measurements may vary +/- 1/8"

Cellular Shade

RECHARGEABLE SIMPLICITY MOTORIZED CELLULAR SHADES

Rechargeable Simplicity Motors

The Simplicity Motor program features a battery powered motor utilizing a rechargeable battery hidden inside the shade head rail. Simplicity motors are compact and use a radio frequency remote to raise or lower the shades.

Rechargeable Motorized Lift Systems are not offered on sizes within the shaded area on the Standard Rectangular price grids.

Applications

- Standard Rectangular

EZ Level

Learn about the EZ Level feature on page 122.

Rechargeable Simplicity Motorization Surcharges

The Rechargeable Simplicity Motorized Lift System surcharge includes a rechargeable battery. Remotes are needed to operate the shades. Refer to pricing pages.

Important Simplicity Motorized Shade Operating and Installation Information

- Simplicity Motorized Shades installed into windows with metal casings may have a reduced radio frequency range, or may not operate at all, depending on the application.
- Do not let the antenna on the motor touch any metal objects. This may interfere with signals from the remote control.

SIMPLICITY RECHARGEABLE BATTERY WAND PRICING EXAMPLE:

Linen Weave	
Light Filtering 42" x 60" Shade:	\$350.00
Simplicity Rechargeable Surcharge:	\$334.00
Charger for Rechargeable :	\$27.00
Simplicity Remote Control:	\$40.00
Total List Price:	\$751.00

Simplicity Rechargeable Battery

The rechargeable battery is concealed in the head rail of the shade. A charger is required for the rechargeable battery. The rechargeable battery comes fully charged from the factory.

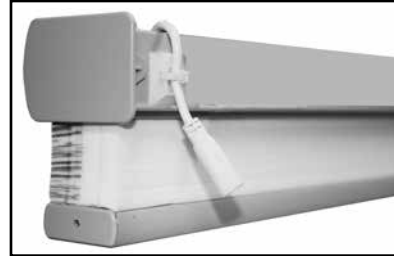

Charging Port on Back of Head rail.

Retrofit Existing Standard Simplicity Motorized Shades with Rechargeable Batteries

Cellular shades made with Standard Simplicity Motorization can be retrofitted with the Rechargeable Simplicity Motorization Battery Wand. The Rechargeable battery wand is 22" long, comes with 10 NiMH batteries, and is white in color. Battery wands are charged at the factory.

To retrofit the rechargeable battery wand to an existing shade with a cassette head rail, you must have at least 24" between bracket centerlines to fit the battery wand. Otherwise, the wand must be placed elsewhere along the window. Wall mounting clips are provided with the wand.

Retrofit Ordering Requirements:

- Rechargeable battery wand with clips (one per shade)
- Rechargeable battery charger (one or more per order, or as needed)
- Charge port mounting base (optional)

Please contact customer service for more information.



Battery Wand for Rechargeable Simplicity Retrofit



Rechargeable Battery Wand Concealed in Head rail. (Minimum width of 30" required) otherwise battery wand must be mounted externally.

Cellular Shade

RECHARGEABLE SIMPLICITY MOTORIZED CELLULAR SHADES

Simplicity Rechargeable Battery Life

Rechargeable batteries are included with the motor.

The average battery charge will last 6-12 months based on an average sized shade raised and lowered once per day. The life of the battery charge will vary based on the type of window covering selected, the size and weight of the window covering and the number of times the shade is operated on a daily basis.

The battery can be recharged up to 500 times. It takes approximately 5 hours to recharge the motor when fully depleted.

Ordering Information for Rechargeable Motorized Cellular Shades

Simplicity Motor Option

- Specify IB or OB mount and rail color.
- Specify remote and other accessories if needed.
- Specify one or more battery chargers.

Please Note:

- Not all motors run at the same rate of speed.
- Simplicity motors have a "Favorites" or "MY" position setting. If the homeowner wants to set several shades at the same intermediate position, follow instructions provided with installation manual.
- Simplicity Rechargeable Motorized Cellular Shades are programmed at the factory with the "up and down" limits. The shades are **UNLINKED** from the remote so they are not able to operate during shipping. Each shade should be installed **before** linking it to the remote.
- **REMEMBER: Order at least one charger if ordering rechargeable motors.**

Simplicity Motorized Shade Warranty

Please see pages 137-138 for complete Comfortex warranty information.

Battery Charger

8.4 Volt charger requires a standard power outlet to recharge the battery wand. Must specify charger when ordering a Simplicity Rechargeable Wand Shade. The charger plugs into the charger port. The charger is black and comes with a 156" wire. The dimensions are 1 7/8" wide x 3 1/4" length x 1 3/4" deep.



Simplicity Motor Hand Held Remotes 5 Channel Remote

The **5 Channel (5C) remote** can operate up to five shades simultaneously, individually or 5 groups. Simplicity Rechargeable Motorized Cellular Shades are programmed at the factory with the "up and down" limits. The shades are **UNLINKED** from the remote so they are not able to operate during shipping. Each shade should be installed **before** linking it to the remote.



Simplicity 5C remotes and holders are white or black in color. The remote comes with a holder which can be mounted to a wall for easy storage. The range of the remote is approximately 80 feet.

6 Channel Timer Remote

The **6 Channel (6C) timer remote** combines the functionality of a six channel hand-held control with the convenience of a programmable timer.

- The 6C timer remote allows for 18 different scheduled actions.
- Manual function disables the timer and the remote then operates as a held remote.

Simplicity 6C remotes and holders are white in color. The remote comes with a holder which can be mounted to a wall for easy storage. The range of the remote is approximately 80 feet.



Simplicity Rechargeable Motorized Cellular Shades are programmed at the factory with the "up and down" limits. The shades are **UNLINKED** from the remote so they are not able to operate during shipping. Each shade should be installed **before** linking it to the remote.

Simplicity Motor Hand Held Remotes Operation

Press the up or down button on the remote to raise or lower the shade to your desired position.

To reprogram channel assignments, please refer to the installation instructions and/or view the video at: comfortexdealers.com/products/motortechsupport.html.

The Simplicity remotes utilize one 3V battery. Batteries are included. Comfortex will warranty batteries for up to 3 months from date of purchase. Batteries are not covered by the warranty.

Cellular Shade Motorization Option SIMPLICITY SMART CONTROLLER

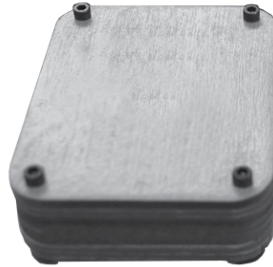

Simplicity Smart Controller Dimensions

- Width of controller: 2³/₈"
- Length of controller: 2¹/₁₆"
- Height of controller: 1¹/₈"

Simplicity Smart Controller

- Works with Apple and Android devices
- FREE Downloadable Application
- Compatible with previously installed Simplicity Remote Control Shades
- Powered by NEO Smart Blinds App

Simplicity Smart Controller

The Simplicity Smart Controller is a small device that you install in your home that allows you to set automatic opening and closing times for all Simplicity motorized shades as well as the ability to control your motorized shades from a phone, tablet or PC from anywhere in world.

The Simplicity Smart Controller will work with any Comfortex remote motorized shade with Simplicity remote control motors purchased after 2012.

The Simplicity Smart Controller plugs into a standard electrical outlet and connects to WiFi and sends signals to your shades using the same radio frequencies as a normal remote control.

How Does The NEO Smart Blinds App Work?

The app uses WiFi or cellular data to send commands over the internet to the Simplicity Smart Controller.

Do I Need Any Other Equipment?

Yes, The location where your shades are installed must have WiFi in order for the Simplicity Smart Controller to work. Additionally, you must have a smartphone or tablet running Android or iOS (eg. iPhone, iPad, Samsung Galaxy S7) and have the NEO Smart Blinds app. installed.

Why Would I Want A Simplicity Smart Controller?

There are two main ways the Simplicity Smart Controller adds additional value to your motorized shades. First, once all of your shades have been added, you can use your smartphone as a single remote for all of your shades that will work anywhere you are regardless of distance from the shade. Secondly, the device allows you to set schedules so your motorized shades automatically open and close without needing to do anything on a day to day basis.

Do I Need To Buy More Than 1 Controller?

The normal use for the Simplicity Smart Controller is to plug it in out of the way and forget it. Since it has roughly the same range as a remote you will want enough devices to allow all shades to be operated without moving the controller. So depending on the layout of the home and location of the shade, you might want multiple devices to have convenient full home coverage.

How Far Is The Range Of A Controller?

You should see a range of approximately 150 ft. However this number might be less depending on the layout of your home. In general we recommend one per a floor of a normal sized home.

Can I Control My Shades From Multiple Devices?

Yes! You can download the NEO Smart Blinds App. onto multiple devices, After installing the App. on a new device simply log in with the same email/password on each device and you will have access to control your shades.

Can It Be Used With Already Installed Shades?

Yes! Simply follow the directions in the NEO Smart Blinds app. to add a shade. At the pairing step you can put the shade in pairing mode using the primary remote control for it (or by accessing the button on the shades motor). Adding the shade to the NEO Smart Blinds App. will not affect the normal remote operation.

How Much Does The NEO Smart Blinds App Cost?

The app is a free download, However you must have at least one Simplicity Smart Controller (\$330) to serve as a bridge between the app and your shades.

Cellular Shade Head Rail Options

POWERTOUCHE RECHARGEABLE MOTORIZED CELLULAR SHADES

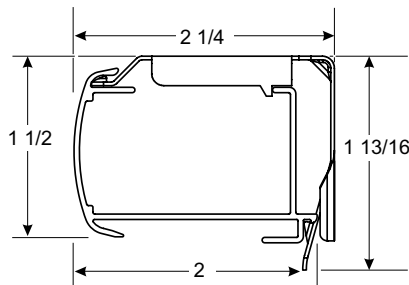
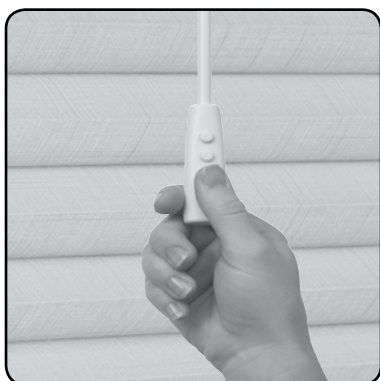

Simplicity Motorized Rail Dimensions

- Depth of rail: 2"
- Depth of rail and bracket: 2 1/4"
- Height of rail: 1 1/2"
- Height of bracket: 1 13/16"

Hardware Features	
Hardware colors for all Cellular and Pleated fabrics	Color coordinated head, middle, bottom rails and end caps
Standard Hardware for all Custom Graphics	White head, middle and bottom rails and end caps
Simplicity Remote	Upper and lower limit stops pre-programmed, Intermediate stop "favorites" position
Upgrades	
Fabric Wrapped Upgrade	Fabric used is same fabric as the shade. Back of rail is white to outside. End caps on fabric wrapped head, middle and bottom rails are color coordinated
Designer Metallic Upgrade	<ul style="list-style-type: none"> • Smooth faced Oil Rubbed Bronze head, middle, bottom rails and end caps • Smooth faced Brushed Nickel head, middle, bottom rails and end caps
Mounting Dimensions	Simplicity Motorized Hardware System
Minimum Shallow Mount	1/2"
Minimum Flush Inside Mount	2 1/4"
Minimum Outside Mount	7/8"
Minimum Side Mount	1 1/4"
Minimum Flush Side Mount	2 1/4"
Recommended Side Mounting Method	<ul style="list-style-type: none"> • See page 65 for recommended mounting method for side mount shades • Width limit for side mount brackets is 48"
Finished Dimensions	
Inside Mount	
	<ul style="list-style-type: none"> • Fabric will measure ordered width less: 3/8" • Head rail* will measure ordered width less: 3/16"
Outside Mount	
	<ul style="list-style-type: none"> • Fabric will measure ordered width • Head rail* will measure ordered width plus: 3/16"
Side Mount	
	<ul style="list-style-type: none"> • Fabric will measure ordered width less: 7/8" • Head rail* will measure ordered width less: 1 1/16"
Exact (End Cap to End Cap) Mount	
	<ul style="list-style-type: none"> • Fabric will measure ordered width less: 3/16" • Head rail* will measure ordered width
* Head rail measurements include endcaps. Width and length measurements may vary +/- 1/8"	

Cellular Shade Head Rail Options

POWERTOUCH RECHARGEABLE MOTORIZED CELLULAR SHADES

PowerTouch™ Rechargeable Shades

Cellular Shades can be fabricated with the PowerTouch Rechargeable Push Button Control option. The PowerTouch Rechargeable option is an easy, cord free motorized operation for the budget savvy homeowner. PowerTouch Rechargeable uses Simplicity motors and components.

PowerTouch Rechargeable Shades Operation

Press the up or down button on the pendant to raise or lower the shading to your desired position. When the shading is fully lowered to the factory programmed lower limit.

No programming is required with PowerTouch™, all programming is set at the factory. Upper and lower limits easily can be adjusted in the field if desired. Please refer to the installation instructions at comfortexdealers.com. A "favorites" or intermediate stop position can be set once installed.

PowerTouch Rechargeable Surcharges

See page 9.

PowerTouch Appearance

- The PowerTouch wand and pendant is attached to the head rail when installed.
- The wand and pendant hangs down the front of the shades from the head rail. The wand does not touch the fabric.
- Pendant is 2½" long.
- The pendant does not need to be mounted to the wall to operate the shade.



PowerTouch Rechargeable Color Options

- Shades with Black or Oil Rubbed Bronze hardware will be built with black wand and pendants standard. All other colors will use white wand and pendants.

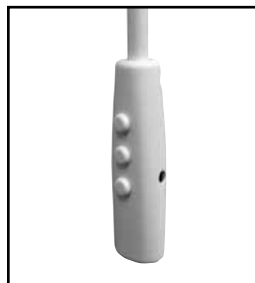

White



Black Shown with Plug-In Charger

PowerTouch Wand and Pendant Location

The standard location for the wand and pendant is on the right. Please specify location when ordering.

PowerTouch Rechargeable Wand Length

- The standard length of the wand will measure the indicated below unless otherwise specified.

Shading Length	Standard Wand Length
Up to 30"	1' (12")
>30" to 52"	2' (24")
>52" to 78"	3' (36")
>78" to 100"	4' (48")
>100" to 120"	5' (60")

Mounting Requirements for PowerTouch Rechargeable Shades

- No special installation hardware or wiring requirements are needed.

Battery Charger

8.4 Volt charger requires a standard power outlet to recharge the battery wand. Must specify charger when ordering a Simplicity Rechargeable Wand Shade. The charger plugs into the charger port. The charger is black and comes with a 156" wire. The dimensions are 1⅞" wide x 3¼" length x 1¼" deep.



PowerTouch Rechargeable Shades Warranty

Please see page 138 for complete warranty information.

Cellular Shade Head Rail Options

OVATION CELLULAR SLIDER | Prelude Hardware Page 110

Hardware

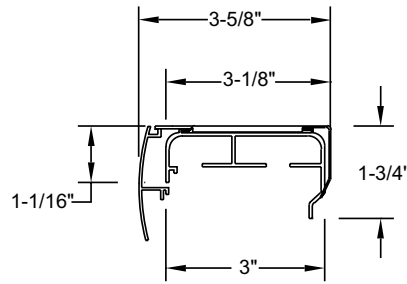

Ovation Hardware Rail Dimensions

- Depth of rail: 3"
- Depth of rail and bracket: 3 1/8"
- Depth of rail, bracket & valance: 3 5/8"
- Height: 1 3/4"

Hardware Features	
Standard Hardware Color	Aspen White #785
Optional Hardware Colors	Ivory, beige, tan and gray rails are available as an option. Visit comfortexdealers.com to view color options <ul style="list-style-type: none"> • Silverado #276 • Honey Bisque #882 • Camel #082 • Gardenia White #862
Mounting Dimensions	
Minimum Inside Mount	3/4"
Minimum Flush Mount	3 5/8"
Minimum Outside Mount	5/8"
Finished Dimensions	
Inside Flush Mount	
Track Width:	
Right or Left Stack	3/16" less than ordered width
Split Stack	3/16" less than ordered width
Center Stack	3/16" less than ordered width
Finished Slider Length	1/2" less than ordered width
Valance	3/16" less than ordered width
Outside Mount	
Track Width	Ordered width
Finished Slider Length	Ordered length - No reductions will be made
Valance	Ordered width plus 1 1/4"
Valance Returns	Will measure 3 1/8" (standard)

Cellular Shade

OVATION CELLULAR SLIDER | Prelude Hardware Page 110

Applications

- Standard Rectangular
- Opens and closes from side to side
- Four stacking options - see below.
- Dual Panel option with a center opening design with two fabrics, one on each side, each spanning the width of the window.

Ovation Stacking Options

Specify stacking configuration when ordering.

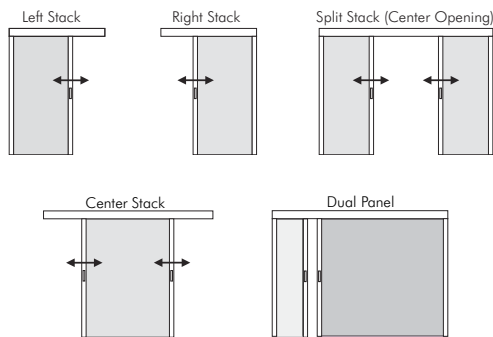

Left: Fabric stacks to the left side of the slider.

Right: Fabric stacks to the right side of the slider.

Center Stack: Center Stack Sliders fabric panels can move fully to the left or the right.

Split Stack: Fabric is split in the center of the slider forming two equal panels which open to opposite ends of the slider. Both panels will be of equal width unless otherwise specified. Split stack is not available with Gradient shades.

* Split stack sliders are available in maximum widths from 240" to 336" (maximum width depends on the fabric selected). If the width exceeds the maximum width of the fabric, it will be fabricated as two separate sliders. The supplied valance will create the appearance of a single slider. Call Customer Service for assistance.

Dual Panel: A Dual Panel Stack Slider has a center opening design with a different fabric on each side, each of which can span the full width of the window. Both panels will be of equal width unless otherwise specified. Specify which fabric stacks to left and which fabric stacks to the right.

Ordering Information for Ovation Cellular Sliders

- Specify IB or OB mount.
- Specify stacking configuration.
 - On Dual Panel Shades, specify which fabric stacks to the left and right.
 - On Split Stack Shades, both panels will be of equal width unless specified.
- Specify valance width and return length.

Ovation Valance Specifications

- Every Ovation Slider is supplied with a painted aluminum valance to match your hardware color choice.
- The valance attaches to the head rail using a durable plastic clip system.

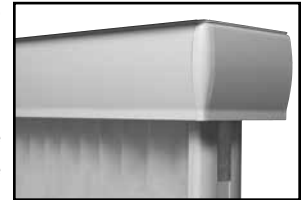

Ovation Valance Dimensions

All valance dimensions are measured on the flat, back side.

- Valance Height: 2 3/4"
- Standard Return Length (OB only): 3 1/8"
- For each spacer block, 1/2" will be added to the length of the valance returns. For extension brackets, 2" will be added unless otherwise instructed.
- If the slider requires a non-flush inside mount, you must order a custom valance. Exact valance width and exact valance return length (minimum 1 1/2") must be specified in the Special Instructions section of the order form.
- Custom returns are available for IB non-flush and OB Cellular Sliders. Please specify return length upon ordering.

Things to Consider

- Since most Ovations are sold in large sizes, the shade will have a large fabric stack. On an outside mount, you may want to order the shade a few inches wider so that the fabric stack can be clear of the window. For more information on Ovation's stack height, see page 16 for information.
- Premiere Custom Design fabrics will be turned 90 degrees on Ovation Shades. The pattern orientation will be left to right since Ovation shades open side to side. Split stack is not available with Gradient shades.
- Symphony double honeycomb fabric may require additional care when opening or closing the shade. Double honeycomb fabric is generally stiffer than single honeycomb material and may offer minor resistance when opening and closing. If this is a concern, Comfortex recommends selecting a coordinating fabric from the Virtuoso or Baritone collections.

The Ultimate Blackout Cellular Shade Head Rail Options

INSULATING SLUMBERSHADES



Standard Head Rail

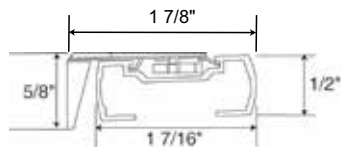

Deluxe Head Rail

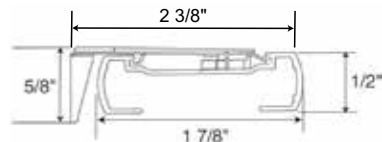

Cord Loop & Cordless Ultra Head Rail (Standard & Top Down-Bottom Up)

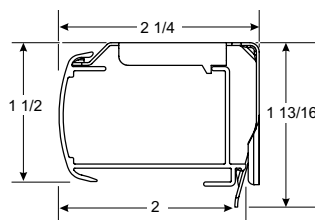

Standard Cord Lock Rail

- Depth of rail: 1 7/16"
- Depth of rail and bracket: 1 7/8"
- Height of rail: 1/2"
- Height of bracket: 5/8"

Deluxe Cord Lock Rail

- Depth of rail: 1 7/8"
- Depth of rail and bracket: 2 3/8"
- Height: 1/2"
- Height of bracket: 5/8"

Cord Loop & Cordless Ultra Rail

- Depth of rail: 2"
- Depth of rail and bracket: 2 1/4"
- Height of rail: 1 1/2"
- Height of bracket: 1 13/16"

Hardware Features		
Hardware colors for all Cellular fabrics	Color coordinated head, middle, bottom rails and end caps	
Blackout Sidetrack Colors Available	White, Tan and Bronze	
Upgrades		
Fabric Wrapped Upgrade	Fabric used is same fabric as the shade. Back of rail is white to outside.	
Designer Metallic Upgrade	• Oil Rubbed Bronze and Brushed Nickel head, middle, bottom rails and end caps.	
Mounting Dimensions (inside mount only)	Standard Head Rail	Deluxe Head Rail
Standard Cord Lock (Standard Retangular and Top Down-Bottom Up)		
Minimum Inside Mount	1 1/2"	1 1/2"
Minimum Flush Inside Mount	2"	2 3/8"
Cord Loop & Cordless Ultra (Standard Retangular and Top Down-Bottom Up)		
Minimum Inside Mount	1 5/8"	NA
Minimum Flush Inside Mount	2 1/4"	NA
Outside, shallow and side mounts are not available. The shade's light blocking ability is compromised by using any other mount than a fully flush mount application.		
Finished Dimensions		
Inside Mount		
	<ul style="list-style-type: none"> • Fabric will measure ordered width less: 7/8" • Head rail and bottom rail will measure ordered width less: 1 1/16" • Sidetrack length will measure ordered length less: 1/8" 	

The widest width of the window cannot exceed the narrowest width of the window by more than 1/4".

Precise width measurements are critical to proper performance of SlumberShade products. Make sure to measure to the nearest 1/16" and provide the **NARROWEST** width measurement along the length of the window. Be sure to measure the top, middle and bottom of the opening. It is very common for the width of a window to vary from top to bottom.

The Ultimate Blackout Cellular Shade Head Rail Options

INSULATING SLUMBERSHADE SHADES

Insulating SlumberShades Small Track Dimensions

Used with all fabrics standard size head rail.

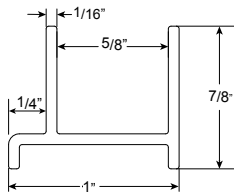

Small Track

- Width of track: 1"
- Height of track: 7/8"

Insulating SlumberShades Large Track Dimensions

Used with all fabrics that utilize the deluxe sized head rail.

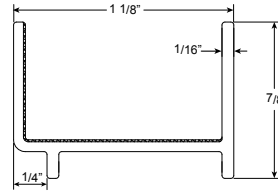

Large Track

- Width of track: 1 1/8"
- Height of track: 7/8"

Applications

- Standard Rectangular
- Top Down - Bottom Up
- Cordless and Cordless Top Down - Bottom Up
- Cord Loop and Top Down - Bottom Up

SlumberShades are for inside mount applications only.

Insulating SlumberShade Fabric

Light Filtering fabrics are available as SlumberShades, however the best light control is achieved by using a blackout cellular fabric.

Ordering Information for Insulating SlumberShades

SlumberShades are for inside mount applications only.

Precise width measurements are critical to proper performance of SlumberShade products. Make sure to measure to the nearest 1/16" and provide the **NARROWEST** width measurement along the length of the window. Be sure to measure the top, middle and bottom of the opening. It is very common for the width of a window to vary from top to bottom. The widest width of the window cannot exceed the narrowest width of the window by more than 1/4".

If you have questions about ordering SlumberShades, contact Comfortex Technical Services at 800-843-4151.

Accessories

- 6' Expandable Pole: \$37.00
- 12' Expandable Pole: \$46.00

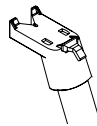

Specially designed pole end fits into the handle on the Cordless Ultra bottom rail and allows for easy operation.

Insulating SlumberShades Features

Use SlumberShades to provide the darkest sleeping environment by sealing out all the light

Energy Saving Blackout Sidetracks

Energy saving blackout sidetracks are made from a durable window grade PVC. The blackout sidetracks seal off the light gap between the blackout cellular shade and the window. The blackout sidetracks feature a black interior lining to absorb light and prevent it from entering the room.



SlumberShades are easy to install, and feature removable sidetracks that are attached to the window frame with magnets. The sidetracks can be removed for window cleaning. The UV stable, window grade PVC sidetracks are available in white, tan and bronze to match your existing trim.

Please Note: When properly installed, SlumberShades block 99% of all visible light. In certain installations with intense sunlight, a very small amount of light may reflect around the edges of the honeycomb fabric along each side of the shade. This is a normal attribute of the SlumberShade system.

Insulating SlumberShade End Caps

The specially designed notched bottom rail end caps fit over the blackout sidetracks and allow for smooth movement when raising and lowering the shade.

Head and Bottom Rail Seals

To ensure a perfectly dark sleeping environment, additional fuzzy seals are supplied to be placed along the shade's bottom rail and between the head rail and the window frame if needed. These barriers provide a complete light stop all the way around the window to keep all exterior light out. Also, these additional seals provide a very effective barrier against heat loss along your windows.

Magnets and fuzzy bar are standard on Cordless and Cordless Top Down-Bottom Up Shades to ensure closure between the bottom rail and window sill.

Energy Efficiency

Independent testing has shown SlumberShades provide an R-value greater than 7.0* when installed over a double paned vinyl window. The testing also indicates that the R-value of a SlumberShade is 2.5 to 3 times higher than that of the same shade without sidetracks. The insulating cellular fabric, sidetracks, and fuzzy seal all ensure that the SlumberShades provides superior energy efficiency.

* Independent testing provided by Consortium for Advanced Residential Buildings (CARB), a U.S. Department of Energy Building America research team. Learn more at comfortexdealers.com.

EZ Level

Learn about the EZ Level feature on page 122.

Cellular Specialty Shades

STARBURST ARCHES | Prelude Hardware Page 112

Hardware

Stationary Starburst

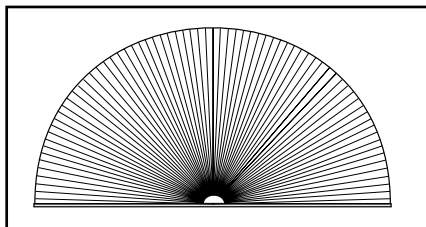

Figure A

Movable Starburst

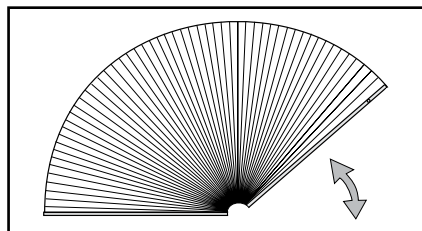

Figure B

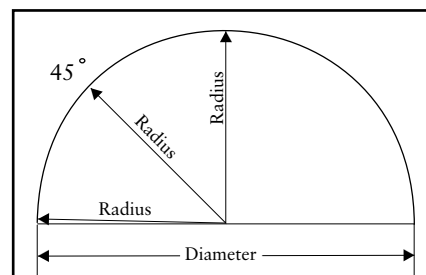

Figure C

Hardware Features | See Page 62 for Rail Dimensions

Hardware colors	Color coordinated rails
-----------------	-------------------------

Upgrades

Fabric Wrapped Upgrade	Fabric used is same fabric as the shade. Back of rail is white to outside. Color coordinated end caps. Please note: On Stationary Starburst Arches the fabric wrap will be spliced in the center of the base rail.
Designer Metallic Upgrade	<ul style="list-style-type: none"> • Oil Rubbed Bronze rails with bronze colored end caps. • Brushed Nickel rails and end caps.

Mounting Dimensions	Standard Cord Lock Rail	Deluxe Cord Lock Rail
Minimum Shallow Mount	3/4"	3/4"
Minimum Flush Inside Mount	2"	2 3/8"
Recommended Side Mounting Method	<ul style="list-style-type: none"> • See page 63 figure B for recommended mounting method for side mount shades • Width limit for side mount brackets is 48" 	

Finished Dimensions

Inside and Side Mount

<ul style="list-style-type: none"> • Fabric will measure ordered width less: 3/8" • Head rail* will measure ordered width less: 3/16" 	<ul style="list-style-type: none"> * Head rail measurements include endcaps. Width and length measurements may vary +/- 1/8"
---	--

Applications

- Stationary Fan Style Arch
 - Movable Fan Style Arch
- Movable Starburst Arch shades are for inside and shallow mount applications only.

Stationary Starburst Features (Figure A)

- **All non-perfect Stationary Starburst arches require a template made from brown craft paper.** Comfortex offers template kits. Please contact Customer Service to order. Stock number: 751000, See page 134
- A perfect arch is twice as wide as it is high.
- Stationary Starburst shades which are not perfect half circles must have a height that equals half the width +/- 5".
- Price according to the largest radius measurement. If the height is greater than the width, take height X 2 and use that number to determine pricing.
- When ordering arches as perfect half-circles make sure the radius of the arch remains constant to ensure a proper fit. (See Figure C)

Movable Starburst Features (Figure B)

- Starburst Movable archtop shades are cut to perfect half circles only and do not require a template. The height must be exactly 1/2 the diameter.
- A perfect arch is twice as wide as it is high.
- When ordering arches as perfect half circles make sure the radius of the arch remains constant to ensure a proper fit. (See Figure C)
- The hinge gap (gap between the two rails) is not centered in the window. The moving rail is always smaller than the stationary rail to provide proper movement within the window.

Accessories

- 6' Expandable Pole: \$37.00
- 12' Expandable Pole: \$46.00

Specially designed pole end fits into the handle on movable Starburst Shades for easy operation.



Cellular Specialty Shades

SUNSET ARCHES | Prelude Hardware Page 113

Movable Sunset

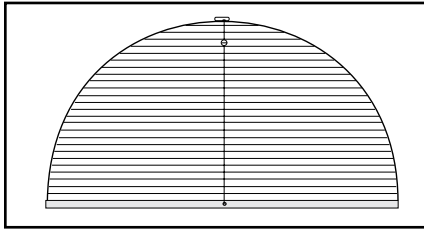

Figure A

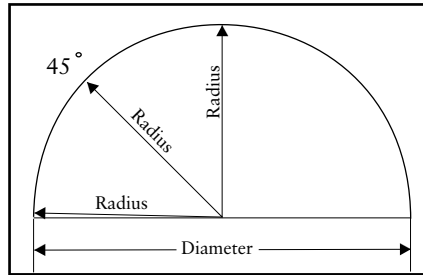

Figure B

Two-String Hanging Method

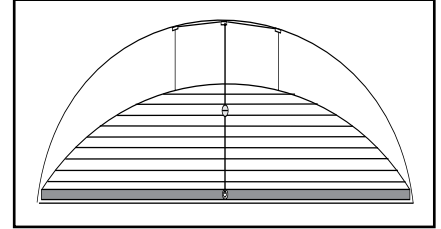

Figure C

Hardware Features See Page 62 for Rail Dimensions		
Hardware colors for all Cellular and Pleated fabrics	Color coordinated rails with white cord and silver tassel	
Upgrades		
Fabric Wrapped Upgrade	Fabric used is same fabric as the shade. Back of rail is white to outside. Color coordinated end caps.	
Designer Metallic Upgrade	<ul style="list-style-type: none"> • Oil Rubbed Bronze rails with bronze end caps, white cord and silver tassel. • Brushed Nickel rails and end caps with silver tassel and white cord. 	
Mounting Dimensions	Standard Cord Lock Rail	Deluxe Cord Lock Rail
Minimum Shallow Mount	3/4"	3/4"
Minimum Flush Inside Mount	2"	2 3/8"
Minimum Outside Mount	3/4"	3/4"
Minimum Side Mount	1 1/8"	1 3/8"
Minimum Flush Side Mount	1 5/8"	1 7/8"
Recommended Side Mounting Method	<ul style="list-style-type: none"> • See page 63 figure B for recommended mounting method for side mount shades • Width limit for side mount brackets is 48" 	
Finished Dimensions		
Inside and Side Mount		
	<ul style="list-style-type: none"> • Fabric will measure ordered width less: 3/8" • Head rail* will measure ordered width less: 3/16" 	
Outside Mount		
	<ul style="list-style-type: none"> • Fabric will measure ordered width • Head rail* will measure ordered width plus: 3/16" 	
Exact (End Cap to End Cap) Mount		
	<ul style="list-style-type: none"> • Fabric will measure ordered width less: 3/16" • Head rail* will measure ordered width 	
* Head rail measurements include endcaps. Width and length measurements may vary +/- 1/8"		

Applications

- Movable Arch

Ordering Information for Sunset Shades

- Specify IB or OB mount and rail color.
- Include a template if the shade is wider than 58".

Accessories

- 6' Expandable Pole: \$37.00
- 12' Expandable Pole: \$46.00



Specially designed pole end fits into the ball on Sunset Shades for easy operation.

Cellular Specialty Shades

SUNSET ARCHES | Prelude Hardware Page 113

Hardware

Sunset Features and Ordering Notes (Figure A)

- Sunset shades have horizontal pleats that stack at the bottom, on a stationary sill rail. Sunset shades are operated by a continuous cord that runs through a top mount guide block and back down through the stationary rail. A moving metal ball attached to the cord is used to raise and lower the shade. (See Figure E).
- **All Sunset arches which are not perfect half circles require a template if shade is wider than 58".** A perfect arch is twice as wide as it is high. See page 134 for template instructions.
- **All templates should be made from brown craft paper.** Comfortex offers template kits. Please contact Customer Service to order. Stock number: 751000
- Sunset shades which are not perfect half circles must have a height which is equal to or greater than 25% of the width.
- When ordering Sunset shades that are perfect half circles, make sure the radius of the arch remains constant to ensure a proper fit. (See Figure B) on page 83.
- **Size Limitations:** Though our maximum width is 84" and our maximum length is 72", there are limitations on some larger sizes due to excessive weight. If the Sunset width exceeds 66", the maximum length is 60". If the Sunset width exceeds 72", the maximum length is 48".
- **Stringing Method:** Depending on the curvature of a particular arch, it may be necessary to use the two string method (See Figure C) to ensure proper fit and operation of your Sunset shade. Comfortex will determine the best stringing method after examination of the template.
- **For Symphony (All), Silk Essence, Premiere 1/2" Fabrics, Virtuoso and Debut 1/2" single:** If Sunset shades exceed 65" in width or 50" in length, two pieces of mono filament cord are included to help stabilize the shade once installed.
- **For Debut 1/2" double, Debut 3/4" Fabrics, Baritone and Linen Weave fabrics:** If Sunset shades exceed 45" in width or in length, two pieces of mono filament cord are included to help stabilize the shade once installed.
- **Arch Styles:** Sunset arches are available in a variety of styles including: palladium, eyebrow and bullet shaped arches. (See Figure D).

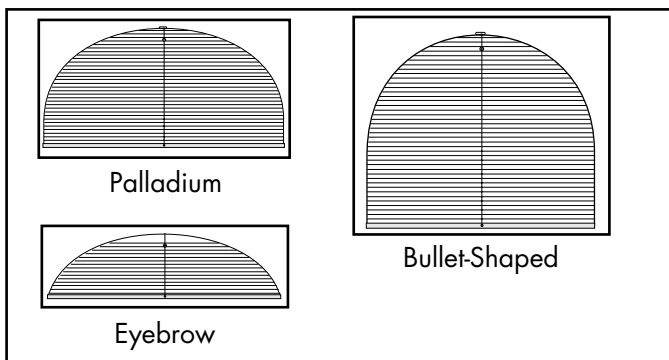

Figure D

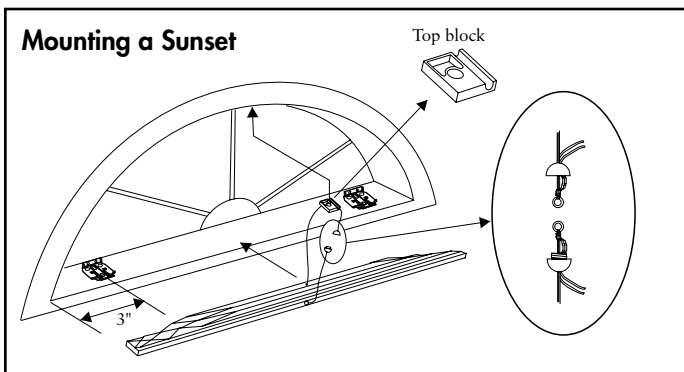

Figure E

Recommended Mounting Method for Side Mounting Shades

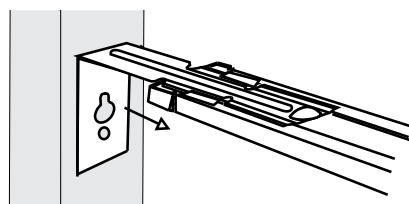

Figure F

Refer to the installation instructions on Comfortexdealers.com or the OnDemand Mobile Library for further details on side mounting shades.

Cellular Specialty Shades

QUARTER ROUNDS | Prelude Hardware Page 115

Movable Quarter Round

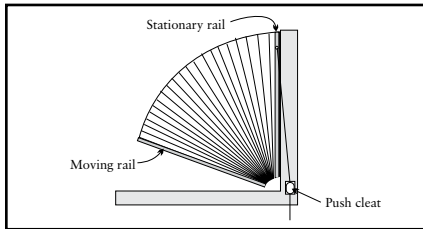

Figure A

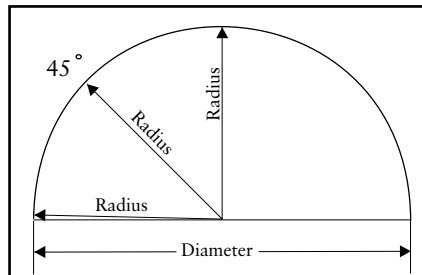

Figure B

Stationary Quarter Round

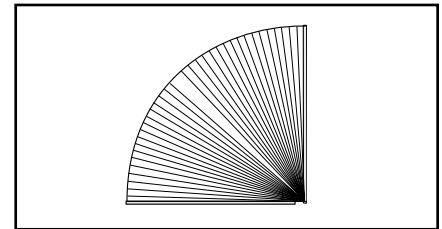

Figure C

Hardware Features See Page 62 for Rail Dimensions		
Hardware colors for all Cellular and Pleated fabrics	Color coordinated rails with white cord and tassel	
Upgrades		
Fabric Wrapped Upgrade	Fabric used is same fabric as the shade. Back of rail is white to outside. Color coordinated end caps.	
Designer Metallic Upgrade	<ul style="list-style-type: none"> • Oil Rubbed Bronze rails and endcaps, bronze colored tassel and white cord. • Brushed Nickel rails and end caps with coordinating tassel and white cord. 	
Mounting Dimensions		
Mounting Dimensions	Standard Rail	Deluxe Rail
Minimum Shallow Mount	3/4"	3/4"
Minimum Flush Inside Mount	2"	2 3/8"
Minimum Outside Mount	3/4"	3/4"
Minimum Side Mount	1 1/8"	1 3/8"
Minimum Flush Side Mount	1 5/8"	1 7/8"
Recommended Side Mounting Method	<ul style="list-style-type: none"> • See page 84 figure F for recommended mounting method for side mount shades 	
Finished Dimensions		
Inside and Side Mount		
	<ul style="list-style-type: none"> • Fabric will measure ordered width less: 3/8" • Head rail* will measure ordered width less: 3/16" 	
Outside Mount		
	<ul style="list-style-type: none"> • Fabric will measure ordered width • Head rail* will measure ordered width plus: 3/16" 	
Exact (End Cap to End Cap) Mount		
	<ul style="list-style-type: none"> • Fabric will measure ordered width less: 3/16" • Head rail* will measure ordered width 	
<p>* Head rail measurements include endcaps. Width and length measurements may vary +/- 1/8"</p>		

Applications

- Stationary Fan Style Quarter Round
- Movable Fan Style Quarter Round

Accessories

- 6' Expandable Pole: \$37.00
- 12' Expandable Pole: \$46.00



Ordering Information for Quarter Rounds Shades

- Specify IB or OB mount and rail color.
- Include a template if the shade is a non-perfect quarter round.

Specially designed pole end fits into the handle on movable Quarter Round Shades for easy operation.

Cellular Specialty Shades

QUARTER ROUNDS | *Prelude Hardware* Page 115

Quarter Rounds Features (Figure A)

- **All Quarter Round Shades which are not perfect quarter circles require a template.** Price according to the largest radius measurement.
- See page 134 for template instructions.
- **All templates should be made from brown craft paper.** Comfortex offers template kits. Please contact Customer Service to order. Stock number: 751000
- The horizontal (moving) rail of a Movable Quarter Round shade **must be smaller** than the vertical (stationary) rail to allow clearance for the moving rail. The shade will stack in the vertical position.
- When ordering arches as perfect quarter circles, make sure the radius of the arch remains constant to ensure a proper fit. (See Figure B)



Cellular Specialty Shades

TRAPEZOIDS AND OCTAGONS | Prelude Hardware Page 116

Movable Trapezoids

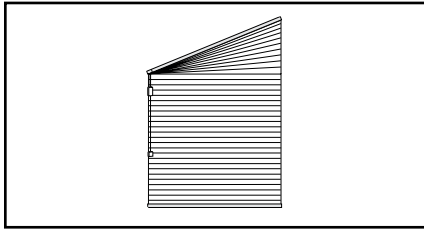

Movable Octagons

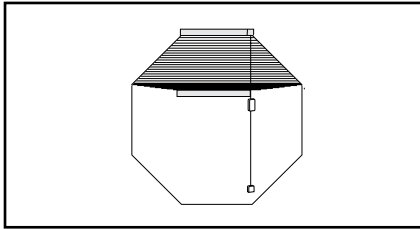

Hardware Features See Page 62 for Rail Dimensions		
Hardware colors for all Cellular and Pleated fabrics	Color coordinated head and bottom rails with white cord and tassel	
Upgrades		
Fabric Wrapped Upgrade	Fabric used is same fabric as the shade. Back of rail is white to outside. Color coordinated end caps.	
Designer Metallic Upgrade	<ul style="list-style-type: none"> • Oil Rubbed Bronze head and bottom rails with bronze colored tassel, end caps and white cord. • Brushed Nickel head and bottom rails and end caps with coordinating tassel and white cord. 	
Mounting Dimensions	Standard Cord Lock Rail	Deluxe Cord Lock Rail
Minimum Shallow Mount	3/4"	3/4"
Minimum Flush Inside Mount	2"	2 3/8"
Minimum Outside Mount	3/4"	3/4"
Minimum Side Mount	1 1/8"	1 3/8"
Minimum Flush Side Mount	1 5/8"	1 7/8"
Recommended Side Mounting Method	• See page 84 for recommended mounting method for side mount shades	
Finished Dimensions		
Inside and Side Mount		
	<ul style="list-style-type: none"> • Fabric will measure ordered width less: 3/8" • Head rail* will measure ordered width less: 3/16" 	
Outside Mount		
	<ul style="list-style-type: none"> • Fabric will measure ordered width • Head rail* will measure ordered width plus: 3/16" 	
Exact (End Cap to End Cap) Mount		
	<ul style="list-style-type: none"> • Fabric will measure ordered width less: 3/16" • Head rail* will measure ordered width 	
* Head rail measurements include endcaps. Width and length measurements may vary +/- 1/8"		

Applications

- Movable Trapezoids
- Movable Octagons

Ordering Information for Trapezoid Shades

- Specify IB or OB mount and rail color.
- Trapezoid orders must be faxed or emailed in with a diagram. Please provide measurements for all four sides when ordering. No template is required.

Ordering Information for Octagon Shades

- Specify IB or OB mount and rail color.
- Octagon Shades do not require a template. The width, length and one side are required measurements when ordering.

Cellular Specialty Shades

TRAPEZOIDS AND OCTAGONS | Prelude Hardware Page 116

Trapezoids (Figure A)

- Trapezoid orders must be faxed in with a diagram. Please provide measurements for all four sides when ordering. No template is required.
- The maximum slope of the top rail is 30 degrees from horizontal. Slope is the angle between slope and a horizontal line. The slope angle must be measured with a protractor.
- Sides of trapezoid must be parallel.
- Sill must be level for proper installation and operation of a trapezoid shade.
- Operating cord must be placed on the short side.
- See Figures B and C for trapezoid shade operation.

Octagons

- Octagon Shades do not require a template.
- The width, length and one side are required measurements when ordering.
- Octagon shades raise only to the point where the top angle begins. (See Figure D)
- See Figure F on page 84 for recommend mounting method for side mount shades.

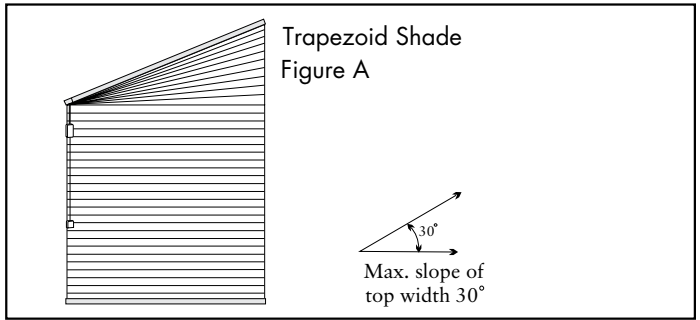

Trapezoid Shade Operation

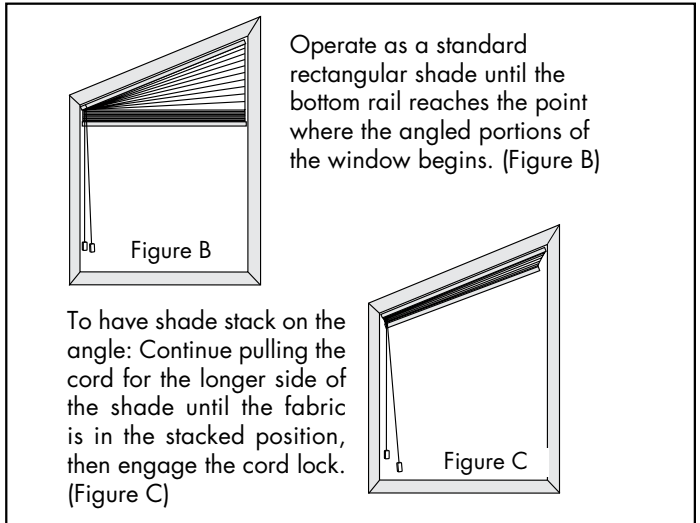

Octagon Operation

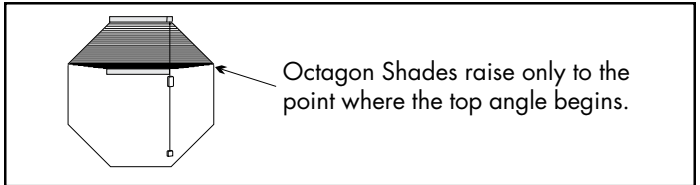

Cellular Specialty Shades SOPRANO SKYLIGHTS AND GREENHOUSE SHADES

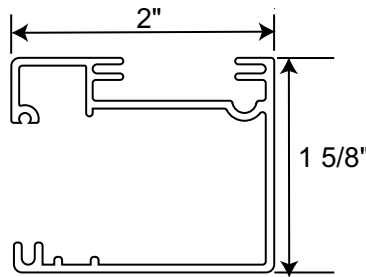

Soprano Rail Dimensions

- Depth of rail: 2"
- Height of rail: 1 5/8"

Hardware Features	
Hardware colors	<ul style="list-style-type: none"> • White head, bottom rail with white geartrack retainer. • Bronze head, bottom rail with bronze geartrack retainer.
Mounting Dimensions	Soprano Skylights and Greenhouse Shades
Minimum depth required for installation	1 1/2"
Minimum Flush Inside Mount (Rail Fully Recessed)	2 3/8"
Minimum Flush Inside Mount (Handle Fully Recessed)	3"
Deductions	
	Total deduction on the bottom moving rail is 3/4"
	Total deduction on the top rail is 1 1/2"
Finished Dimensions	
Inside Mount	
	<ul style="list-style-type: none"> • Fabric will measure ordered width less: 3/8" • Head rail* will measure ordered width less: 3/16"
* Head rail measurements include endcaps. Width and length measurements may vary +/- 1/8"	

Applications

- Soprano Skylights
 - Soprano Greenhouses
- Soprano Shades are for inside mount applications only.

Accessories

- Two Moving Rails: \$129.00
- 6' Expandable Pole: \$37.00
- 12' Expandable Pole: \$46.00

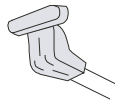

Specially designed pole end fits into the handle of Soprano shades for easy operation at any angle.

Ordering Information for Soprano Skylights and Greenhouse Shades

- Specify White or Bronze Rails.
- For Greenhouse Shades, supply measurements for: straight top section, curved section and vertical straight section when ordering.

Skylight Installation Angles

- For inside mount applications on straight (planar) runs.
- Minimum Installation angle of 5 degrees.
- Maximum installation angle of 85 degrees.
- Horizontal (0 degrees) and vertical (90 degrees) applications are not recommended.

Cellular Specialty Shades

SOPRANO SKYLIGHTS AND GREENHOUSE SHADES

Soprano Skylight Features (Figure A)

- Soprano Shades feature a polycarbonate track system. The hidden geartrack allows for smooth operation of the shade and controls light.
- The geartrack retainer is White or Bronze to match the moving bottom rail. **Please specify rail color when ordering.**

Soprano Greenhouse Shades Features (Figure B)

- See Figure C below for Greenhouse shade ordering information.
- Soprano Shades are for inside mount applications only.
- **All greenhouse orders require a completed and signed greenhouse shade order form.** Orders must be mailed or faxed to Comfortex for processing. Download a copy at www.comfortexdealers.com or from the OnDemand Library Mobile Library.
- Soprano Shades feature a polycarbonate track system. The hidden geartrack allows for smooth operation of the shade and controls light.
- The geartrack retainer is White or Bronze to match the moving bottom rail. **Please specify rail color when ordering.**

Soprano Skylights

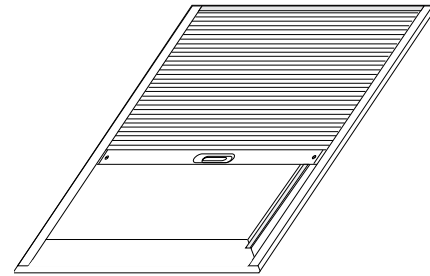

Figure A

Soprano Greenhouses

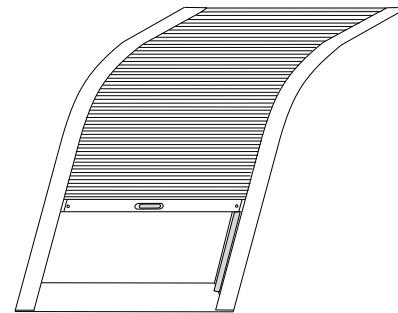
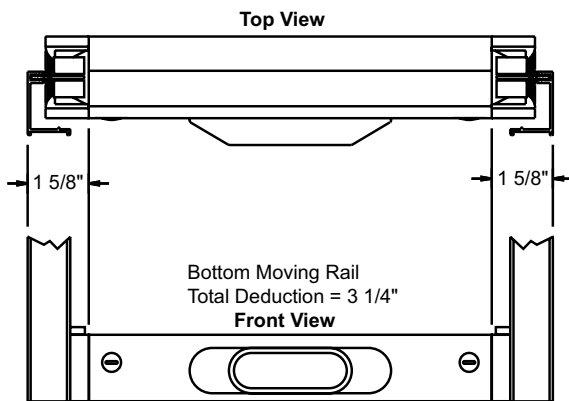
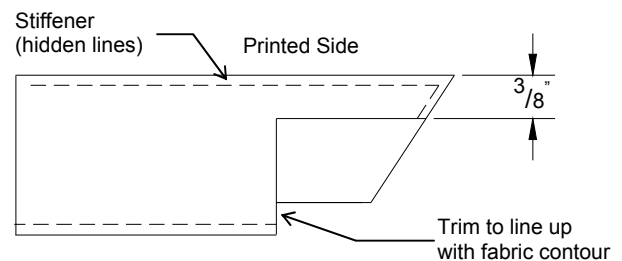

Figure B



Soprano Skylights and Greenhouses Moving Rail
Top and Front View

Soprano Fabric Notch



Additional trimming for bottom stiffener (and attached single layer of fabric).

Greenhouse Ordering Information Figure C

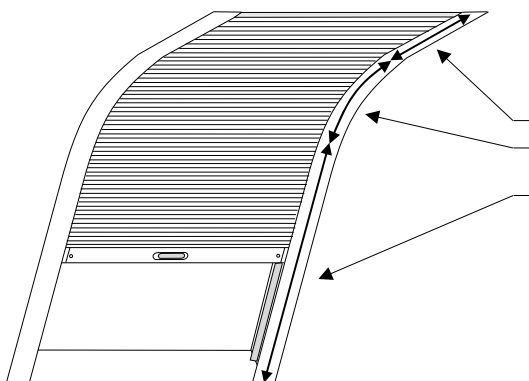

The side rails for greenhouse shades are notched at the curve in the factory. Please supply measurements for:
 Straight top section,
 Curved section and
 Vertical straight section when ordering.

Cellular Specialty Shades

BALCONY SHADING SYSTEM

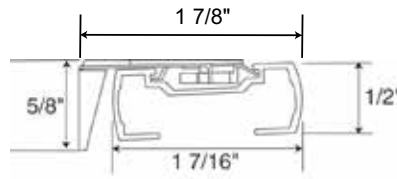
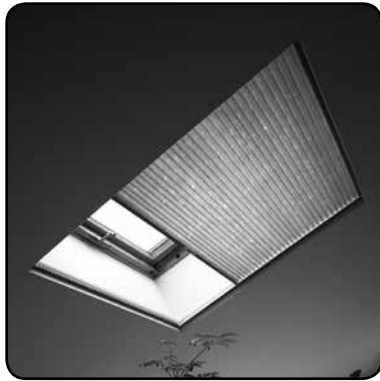

Balcony Rail Dimensions

- Depth of rail: 1 7/16"
- Depth of rail and bracket: 1 7/8"
- Height of rail: 1/2"

Hardware Features

Hardware colors for all fabrics	Color coordinated head and bottom rails with white cord in a white sidetrack.
---------------------------------	---

Upgrades

Fabric Wrapped Upgrade	Fabric wrapped head and bottom rails. Fabric used is same fabric as the shade. Back of rail is white to outside.
Designer Metallic Upgrade	<ul style="list-style-type: none"> • Designer Oil Rubbed Bronze head and bottom rails with white cord in a white sidetrack. • Designer Brushed Nickel head and bottom rails with white cord in a white sidetrack.

Mounting Dimensions - Inside Only	Balcony Shading System
Minimum required for installation	1 1/4"
Minimum Flush Inside Mount (Rail Fully Recessed)	2 1/4"
Minimum Flush Inside Mount (Handle Fully Recessed)	2 1/16"

The widest width of the window cannot exceed the narrowest width of the window by more than 3/8".

Finished Dimensions

Inside Mount

	<ul style="list-style-type: none"> • Fabric will measure ordered width less: 3/8" • Head rail* will measure ordered width less: 3/16"
--	---

* Head rail measurements include endcaps. Width and length measurements may vary +/- 1/8"

Applications

- Horizontal, Angled and Vertical rectangular windows and skylights. Balcony Shading Systems are for inside mount applications only.

Accessories

- 6' Expandable Pole: \$37.00
- 12' Expandable Pole: \$46.00



Specially designed pole end fits into the handle of Balcony shades for easy operation at any angle.

Ordering Information for Balcony Shading System

- Specify rail color.
- Specify when ordering: Application angle: Angled, Horizontal or Vertical.

Cellular Specialty Shades

BALCONY SHADING SYSTEM

Balcony Shading System Features

- Balcony Shades work in three orientations applications: Angled, Horizontal and Vertical.
Horizontal works on slope angles 0 to 15 degrees.
Angled works on slope angles 15 to 75 degrees.
Vertical works on slope angles 75 to 90 degrees.
- Balcony shades can be mounted on their side. (See Figure A). Use the vertical measurement as your width (max. 36") and the horizontal measurement as your length (max. 48").
- Polycarbonate track system provides superior insulation and light blocking. The enclosed sides provide full privacy.
- No exposed cords, eliminates risk of injury to children.

Balcony Vertical Applications

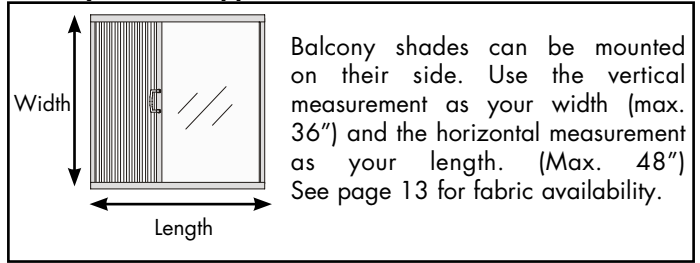

Figure A

Maximum Shade Area

Maximum shade areas (in square feet) varies with slope and fabric type.

	Horizontal	Angled	Vertical
Symphony (All)	24	24	18
Debut Light Filtering (All)	24	24	18
Virtuoso (All)	24	24	18
Silk Essence	24	24	18



Cellular Specialty Shades

MEZZO MOTORIZED SKYLIGHT SHADES

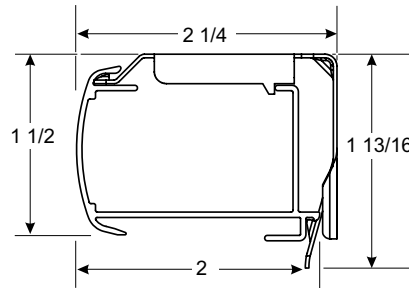

Simplicity Motorized Rail Dimensions

- Depth of rail: 2"
- Depth of rail and bracket: 2 1/4"
- Height of rail: 1 1/2"
- Height of bracket: 1 13/16"

Hardware Features

Hardware colors	White head, bottom and side rails
Simplicity Remotes	Upper and lower limit stops pre-programmed, Intermediate stop "favorites" position can be programmed on-site, 5 Channel or 6 Channel Timer option

Mounting Dimensions	Mezzo Motorized Skylight Shades
Minimum Flush Inside Mount	2 1/2"
	<ul style="list-style-type: none"> • Should not be more than 1/2" out of square to perform as intended • The widest width of the window cannot exceed the narrowest width of the window by more than 3/8". • The shade must be mounted with the fabric stack at the bottom or the lowest point of the window
	See page 94 for Solar Panel Mounting information.

Finished Dimensions

Inside Mount	
	<ul style="list-style-type: none"> • Fabric will measure ordered width less: 1 1/4" • Head rail* will measure ordered width less: 3/16"

* Head rail measurements include endcaps. Width and length measurements may vary +/- 1/8"

MOTORIZATION - HARDWARE UPGRADE SURCHARGES AND ACCESSORIES All standard discounts apply to motorized shades	ADD
Simplicity - Motor and Battery Wand	\$334
Simplicity 5 Channel Remote	\$40
Simplicity 6 Channel Remote with Timer	\$65
48" Extension Wire:	\$18
DC Power Supply	\$63
Simplicity Smart Controller (NEO)	\$330
Solar Panel Recharge Kit : Includes Solar Panel with brackets, rechargeable battery wand with clips and Y cable	\$173
Plug In Charger: for rechargeable battery wand in Solar Recharge Kit	\$54

Applications

- Horizontal, Angled and Vertical motorized skylight shades.
- Mezzo Motorized Skylight Shades are for inside mount applications only.

Ordering Information for Mezzo Motorized Skylight Shades

- Specify inside mount dimensions.
- Specify fabric color and style.
- Specify remote and other accessories if needed.

Cellular Specialty Shades

MEZZO MOTORIZED SKYLIGHT SHADES

Solar Panel Recharge Option

Instead of disposable alkaline or lithium batteries, use a battery wand with rechargeable batteries to harness the power of the sun.

A Simplicity solar panel converts the sun's light into electrical energy providing a constant trickle charge for the rechargeable batteries.

The solar panel measures 21" x 2 3/4" x 1/2".

The rechargeable battery wand measures 22" long.

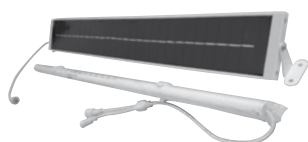

Dimensions of panel
21" x 2 3/4" x 1/2"

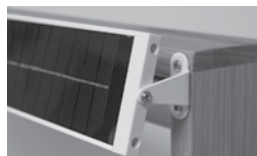

Side View of Panel

Solar Recharge Optimum

Application

- Full direct sunlight (minimum 4-6 hours per day) to maintain full charge. Based on one operation cycle per day (one open, one close).
- Solar panel will charge batteries even without direct sunlight. Ambient light will charge the batteries but at a slower rate.
- Excessive duration of cloudy weather will impact the rate of charge.
- 12 Volt DC power supply is available if you find that your application does not provide sufficient solar energy to maintain a full charge.
- 12 Volt DC power supply requires a standard power outlet to power the motor. The transformer is an alternative to a battery wand. Each transformer can power a single shade with a Simplicity motor. The DC power supply is white and comes with a 80" wire. The dimensions are 1 7/8" wide x 3 1/4" long x 1 1/4" deep.



Solar Panel Mounting

The solar panel can be mounted to the window casing with supplied brackets or can be mounted directly to the glass using supplied special double stick tape (Figures A-B).

- **Inside Mount - Solar Panel Mounted to Glass:** Minimum depth for flush inside mount when mounting the solar panel directly to glass: 3"
- **Inside Mount - Solar Panel Mounted to Glass with battery wand:** 4"
- **Inside Mount - Solar Panel Mounted with Brackets:** Minimum depth for flush inside mount when mounting the solar panel with the supplied swivel brackets: 4 1/4"
- **Inside Mount - Solar Panel Mounted with Brackets with battery wand:** 5 1/4"
- **The shade must be mounted with the fabric stack at the bottom or the lowest point in the window.**

Solar Panel Location Requirements

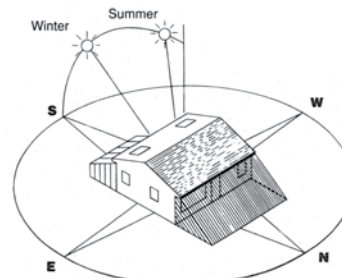

For Locations North of Washington, DC (39° Latitude)

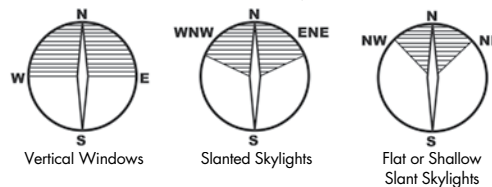

For Locations South of Washington, DC (39° Latitude)

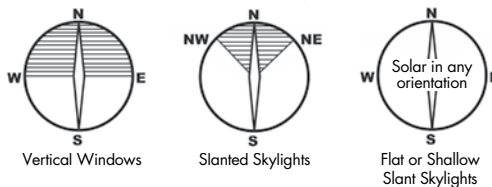

- Assumptions:** 1) Window area free from shadows 9 AM to 3 PM.
2) Glazing is double pane, clear.

Excessive shading or tinted glass will impact the solar charging capability of the system.

- Indicates orientations which may require periodic manual recharge with Plug In Charger.
- Indicates orientations which are optimum for solar recharge (wireless systems).

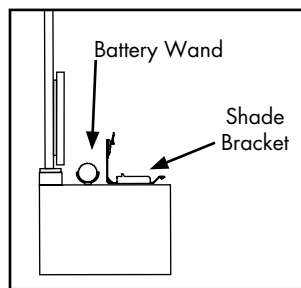

Figure A
Shade with Solar Panel Mounted to Glass

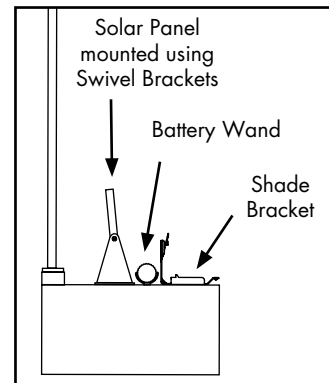
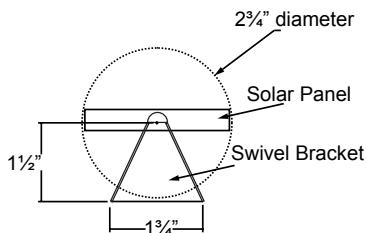

Figure B
Shade with Solar Panel Mounted using Supplied Swivel Brackets



Cellular Specialty Shades

MEZZO MOTORIZED SKYLIGHT SHADES

Simplicity Hand Held Remotes

The 5 Channel (5C) remote can operate up to five shades simultaneously, individually or 5 groups. **WHEN ORDERING PLEASE SPECIFY WHICH CHANNELS ARE ASSIGNED TO EACH SHADE OR GROUP OF SHADES.** For example; program line 1 to channel 1, line 2 and 3 to channel 2, etc. If no channels are assigned at time of order, all shades will be programmed to Channel 1. **To reprogram channel assignments, please refer to the installation instructions and/or view the video at comfortexdealers.com/products/motortechsupport.html.**



A **6 Channel (6C) timer remote** is also available. See page 74 for more information

The 5C Simplicity remote and holders are white or black in color. The remote comes with a holder which can be mounted to a wall for easy storage. The range of the remote is approximately 80 feet.

The Simplicity remote utilizes one 3V battery (CR2032). Batteries are included. Comfortex will warranty batteries for up to 3 months from date of purchase.

Important Simplicity Motorized Shades Operating and Installation Information

- Simplicity Motorized Shades installed into windows with metal casings may have a reduced radio frequency range, or may not operate at all, depending on the application.
- Do not let the antenna on the motor touch any metal objects. This may interfere with signals from the remote control.
- Make sure to leave the top of the shade head rail open (motor exposed), do not cover; especially with metal materials. This could result in a reduced radio frequency range for the remote control or the shade may not operate at all, depending on the application.



Cellular Specialty Shades

PRIVADA PRIVACY PLEATED SKYLIGHT SHADING SYSTEM

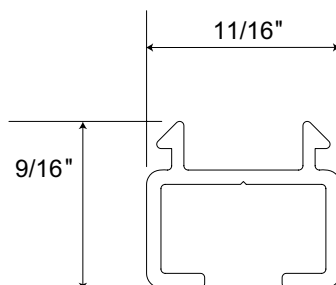

Privada Rail Dimensions

- Depth of rail: 11/16"
- Height of rail: 9/16"

Hardware Features	
Hardware colors	Off-white aluminum head and bottom rails with off-white cord (standard).
Mounting Dimensions	Privada Skylight Shades
Minimum required for installation	1"
Minimum Flush Inside Mount (Fabric Fully Recessed)	1 1/2"
	The widest width of the window cannot exceed the narrowest width of the window by more than 3/8".
Finished Dimensions	
Inside Mount	
	<ul style="list-style-type: none"> • Fabric will measure ordered width less: 3/8" • Head rail* will measure ordered width less: 3/16"
* Head rail measurements include endcaps. Width and length measurements may vary +/- 1/8"	

Applications

- Horizontal, Angled and Vertical shades.
- Privada Skylight Shading Systems are for inside mount applications only.

Privada Skylight Shading System Features

- Privada Skylight Shading Systems are for inside mount applications only.
- Total shade area must not exceed 18 square feet.
- Save money on heating and cooling bills, Privada can help reduce heat gain by 50% in the summer and 40% of heat loss in the winter.
- Privada fabrics can reduce ultraviolet penetration by 90% to prevent fading of carpets and other furnishings.

Ordering Information for Privada Skylight Shading Systems

- Specify inside mount dimensions.
- Specify fabric color and style.

Accessories

- 6' Expandable Pole: \$37.00
- 12' Expandable Pole: \$46.00



Specially designed pole end fits into the handle of Privada shades for easy operation at any angle.

Bottom Rail Gap

The handle creates a gap between the moving rail and the stationary bottom rails on Privada Skylight Shading Systems. To minimize this gap, white fuzz bar is applied to the moving and bottom rail.



Cellular Specialty Shades FRENCH DOOR DÉCOR



Standard Head Rail

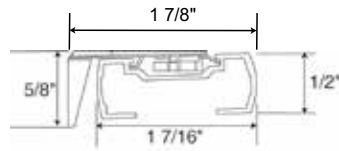

Deluxe Head Rail

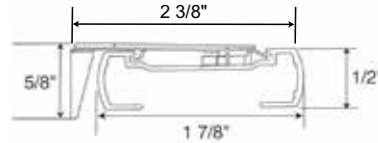

Standard Rail

- Depth of rail: 1 7/8"
- Depth of rail and bracket: 1 7/8"
- Height of rail: 1/2"
- Height of bracket: 5/8"

Deluxe Rail

- Depth of rail: 1 7/8"
- Depth of rail and bracket: 2 3/8"
- Height: 1/2"
- Height of bracket: 5/8"

Hardware Features

Hardware colors	Color coordinated head, middle, bottom rails and end caps
-----------------	---

Upgrades

Fabric Wrapped Upgrade	Fabric used is same fabric as the shade. Back of rail is white to outside. Color coordinated end caps
Designer Metallic Upgrade	<ul style="list-style-type: none"> • Oil Rubbed Bronze head, middle, bottom rails and end caps. • Brushed Nickel head, middle, bottom rails and end caps.

Mounting Dimensions	Standard Rail	Deluxe Rail
Minimum Shallow Mount	3/4"	3/4"
Minimum Flush Inside Mount	2"	2 1/2"
Minimum Flush Inside Mount (Handle Fully Recessed)	2 9/16"	3"
Minimum Outside Mount	3/4"	3/4"
Minimum Side Mount	1 1/8"	1 3/8"

The widest width of the window cannot exceed the narrowest width of the window by more than 3/8".

Recommended Side Mounting Method	<ul style="list-style-type: none"> • See page 84 for recommended mounting method for side mount shades • Width limit for side mount brackets is 48"
---	---

Finished Dimensions

Inside and Side Mount

	<ul style="list-style-type: none"> • Fabric will measure ordered width less: 3/8" • Head rail* will measure ordered width less: 3/16"
--	---

Outside Mount

	<ul style="list-style-type: none"> • Fabric will measure ordered width • Head rail* will measure ordered width plus: 3/16"
--	--

Exact (End Cap to End Cap) Mount

	<ul style="list-style-type: none"> • Fabric will measure ordered width less: 3/16" • Head rail* will measure ordered width
--	--

* Head rail measurements include endcaps. Width and length measurements may vary +/- 1/8"

Cellular Specialty Shades

FRENCH DOOR DÉCOR

Applications

- Stationary Door Décor
- Movable Door Décor
- Top Down - Bottom Up Door Décor
- Cover french doors, transoms, and side lights.

French Door Décor Hardware Features

- Features two non-moving rails which are mounted in the window or door. A tension control system enables the movable rail to be easily moved with the touch of a finger. The only visible cords are the ones that hold the movable middle rail in place.
- The widest width of the window cannot exceed the narrowest width of the window by more than $\frac{3}{8}$ ".

Stationary Non-Movable French Door Décor Shades

- Top and bottom rails are mounted to the window and are stationary.

Movable French Door Décor Shades

- Top and bottom rails are mounted to the window, one middle movable rail raises from the bottom.

Top Down - Bottom Up Option

- Top and bottom rails are mounted to the window, two movable rails allow the shade to lower from the top and raise from the bottom.
- The non-movable top and bottom rails are attached to the window or door.
- Ideal for entry ways with narrow windows next to doors and other narrow windows that are easily accessible.

Ordering Information for French Door Décor

- Specify IB or OB mount and rail color.
 - Specify stationary, movable or Top Down - Bottom Up.
- You may want to specify hold down brackets if mounting on a door.

Accessories

- 6' Expandable Pole: \$37.00
- 12' Expandable Pole: \$46.00

Specially designed pole end allows for easy operation of French Door Décor Shades.

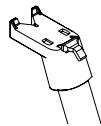

French Door Decor Cellular Shades Hardware

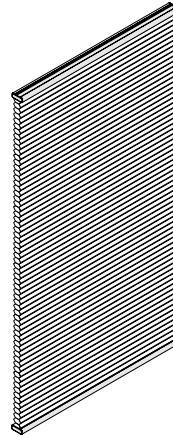

Stationary Non-Movable

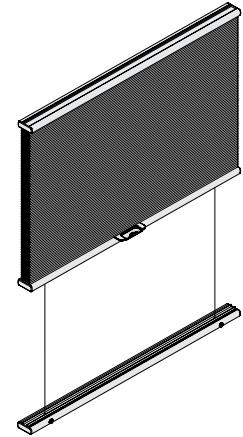

Shown open with movable rail option

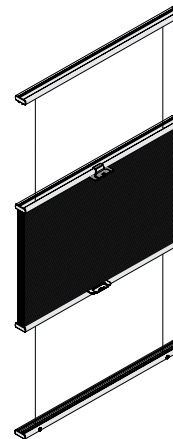

Shown open with Top Down - Bottom Up Option

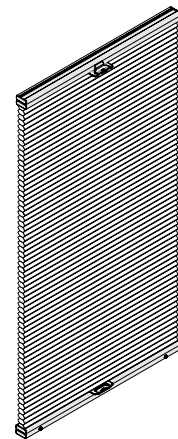

Shown closed with Top Down - Bottom Up Option

Cellular Specialty Shades

DAY-NIGHT SHADES



Standard Cord Lock Rail

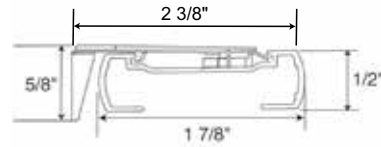
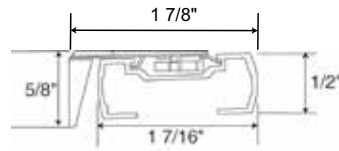

Standard Cord Lock Rail

- Depth of rail: 1 7/16"
- Depth of rail and bracket: 1 7/8"
- Height of rail: 1/2"
- Height of bracket: 5/8"

Deluxe Cord Lock Rail

- Depth of rail: 1 7/8"
- Depth of rail and bracket: 2 3/8"
- Height: 1/2"
- Height of bracket: 5/8"

Hardware Features	
Hardware colors for all Cellular and Pleated fabrics	Color coordinated head, middle and bottom rails with white cord and tassel. See additional details on page 100.
Upgrades	
Fabric Wrapped Upgrade	Fabric used is same fabric as the shade. Back of rail is white to outside. Color coordinated end caps.
Designer Metallic Upgrade	<ul style="list-style-type: none"> • Oil Rubbed Bronze head and bottom rails with bronze colored tassel, end caps and white cord. • Brushed Nickel head and bottom rails and end caps with coordinating tassel and white cord.
Mounting Dimensions	
Minimum Shallow Mount	Standard Rail: 3/4" Deluxe Rail: 3/4"
Minimum Flush Inside Mount	Standard Rail: 2" Deluxe Rail: 2 3/8"
Minimum Outside Mount	Standard Rail: 3/4" Deluxe Rail: 3/4"
Minimum Side Mount	Standard Rail: 1 1/16" Deluxe Rail: 1 3/8"
Recommended Side Mounting Method	<ul style="list-style-type: none"> • See page 84 for recommended mounting method for side mount shades • Width limit for side mount brackets is 48"
Finished Dimensions	
Inside and Side Mount	
	<ul style="list-style-type: none"> • Fabric will measure ordered width less: 3/8" • Head rail* will measure ordered width less: 3/16"
Outside Mount	
	<ul style="list-style-type: none"> • Fabric will measure ordered width • Head rail* will measure ordered width plus: 3/16"
Exact (End Cap to End Cap) Mount	
	<ul style="list-style-type: none"> • Fabric will measure ordered width less: 3/16" • Head rail* will measure ordered width
* Head rail measurements include endcaps. Width and length measurements may vary +/- 1/8"	

Applications

- Standard Rectangular with cellular fabrics only.

Day - Night Shade Specifications

Refer to the appropriate fabric sections for proper pricing.

Fabrics

- Privada fabrics cannot be used to build a Day-Night Shade. Some fabrics (i.e. Symphony Blackout) can be used exclusively only as a bottom panel only.

Cellular Specialty Shades
DAY-NIGHT SHADES

Rail Colors and Cord Colors

- **Color Coordinated Rail Shades:** The top rail and middle rail will coordinate with top fabric and bottom rail will coordinate with the bottom fabric. The cord and tassel will be white. Not available with Color Lux Shades.
- **Designer Metallic Hardware Shades:** All rails, end caps and tassels will be the selected metallic color. Cords will be white.
- **Fabric Wrapped Rail Shades:** The top rail and middle rail will coordinate with top fabric and bottom rail will coordinate with the bottom fabric. The cord and tassel will be white. End caps and cord lock will be color coordinated.

Ordering Information for Day - Night Shade

- Specify fabrics, top and bottom panels.
- Specify IB or OB mount and rail color.

TOP FABRIC

BOTTOM FABRIC

CELLULAR	Width		Length	
	Min	Max	Min	Max
Verona	12"	72"	18"	96"
Boutique	12"	72"	18"	96"
Baritone (all)*	12"	72"	18"	96"
Debut 1/2" Double Cell Light Filtering	12"	72"	18"	96"
Debut 1/2" Single Cell Light Filtering	12"	72"	18"	96"
Debut 3/4" Single Cell Light Filtering	12"	72"	18"	96"
Linen Weave Light Filtering*	12"	72"	18"	96"
Linen Weave Room Darkening*	NA	NA	NA	NA
Natural Linen Flax 1/2" Sheer Light Filtering	12"	72"	18"	96"
Premiere 1/2" Single Cell Blackout	NA	NA	NA	NA
Premiere 1/2" Single Cell Light Filtering	12"	72"	18"	96"
Premiere 3/4" Single Cell Blackout	NA	NA	NA	NA
Premiere 3/4" Single Cell Light Filtering	12"	72"	18"	96"
Silk Essence 1/2" Single Cell Light Filtering	12"	72"	18"	96"
Symphony 3/8" Double Cell Blackout	NA	NA	NA	NA
Symphony 3/8" Double Cell Light Filtering	12"	72"	18"	96"
Virtuoso 1/2" Single Cell Blackout	12"	72"	18"	96"
Virtuoso 1/2" Single Cell Light Filtering	12"	72"	18"	96"

Width		Length	
Min	Max	Min	Max
12"	72"	18"	96"
12"	72"	18"	96"
12"	72"	18"	96"
12"	72"	18"	96"
12"	72"	18"	96"
12"	72"	18"	96"
12"	72"	18"	96"
12"	72"	18"	96"
12"	72"	18"	96"
12"	72"	18"	96"
12"	72"	18"	96"
12"	72"	18"	96"
12"	72"	18"	96"
12"	72"	18"	96"
12"	72"	18"	96"
12"	72"	18"	96"
12"	72"	18"	96"
12"	72"	18"	96"
12"	72"	18"	96"
12"	72"	18"	96"
12"	72"	18"	96"
12"	72"	18"	96"

* Day-Night Shades can only be built in conjunction with other 3/4" cellular fabrics. All Debut includes print patterns: Strie, Terazzo, Angel Hair, Strat, Florance, Blossom, Country Woven and Homespun.

Cellular Specialty Shades

CUSTOM GRAPHICS

Custom Graphics

With Custom Graphics, you can print anything on a Cellular Shade. From logos to personal photos, theme room graphics or advertising for your storefront, anything you envision can be featured on a Custom Graphics Cellular Shade.

Hardware | Mounting | Finished Dimensions

See Page 62

Available Fabrics

Custom Graphics are available with the following fabrics:

- Premiere 1/2" and 3/4" Light Filtering Fabrics
- Premiere 1/2" and 3/4" Blackout Fabrics

Custom Graphics can work for any window.

Advertising and Store Identification

Contact local businesses and explain how you can to turn their window space into advertising!



Decorative and Personal Photos

Customers can now convert their special photos into a highly personalized room!

Printing Information and Options

Custom Graphics will look different from fabric to fabric. The color vibrancy on cellular shades will be muted due to the density of the fabrics and the printing process.

To view the color differences on Cellular Shades, visit the Custom Graphic section of the Comfortex Dealers website.

Single Sided Printing:

Cellular Custom Graphics are available as single-sided only. Double-sided graphics are not available.

You can choose to have Side A face the room side or the street side.



Side A
Shows Printed Image



Side B
White Fabric

Ordering Information for Custom Graphics Cellular Shades

Step 1. Fill out the Custom Graphics Cellular Shades

Order Form. This form includes your fabric and hardware selections. Fax the completed order form to (800) 336-4580 to place your order.

Custom Graphic orders can only be placed by faxing this form.

Step 2. Receive your Comfortex Work Order Confirmation

number. Be sure to reference this number when submitting you artwork in Step 3.

Step 3. Send your graphic files via email to:

CustomGraphics@Comfortex.com

Or ship a CD containing your graphics to:

Custom Graphics
Comfortex Window Fashions
21 Elm Street
Maplewood, NY 12189

Graphic File Specifications

Preferred Formats:

- Adobe Illustrator
- EPS

Other Accepted Formats:

- TIFF
- JPEG
- PSD

- All typography should be converted to paths when submitting an Illustrator or EPS file.
- TIFF and JPEG files should be submitted at the largest size possible, 300 DPI is preferred. We will size your graphics according to your shade size and specifications.
- Contact Comfortex Customer Care at 800-843-4151 with all questions regarding Custom Graphic Orders.
- Comfortex will not print any copyrighted custom graphics without appropriate permission.

Step 4. The Custom Graphic Team will email a PDF proof of your shade order for you to approve. Once the artwork is approved, it will take two weeks for your order to be printed, assembled, and shipped.

Prelude Cellular STANDARD CORD LOCK SHADES

Prelude Hardware

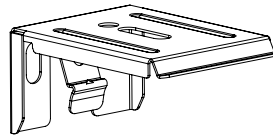

Standard Bracket

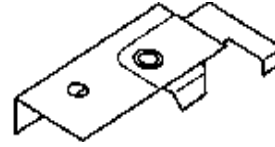

Swivel Bracket



End Mount Bracket

Hardware Features

Standard Hardware colors for Comfortex Prelude	Color coordinated head, middle and bottom rails with color coordinated cord and tassel.
--	---

Upgrades

Fabric Wrapped Upgrade	Not Available on Cord Lock Shades
Designer Metallic Upgrade	Not Available on Cord Lock Shades

Mounting Dimensions

	Standard Bracket	Swivel Bracket	End Mount Bracket
Minimum Depth Inside Mount	1 1/4"	1/2"	NA
Minimum Flush Inside Mount	2 1/4"	2"	2"
Minimum Outside Mount	1"	1"	1"

Maximum End Mount Shade width 36"

Finished Dimensions

Inside Mount

- Fabric will measure ordered width less: 3/8"
- Head rail* will measure ordered width less: 3/16"
- Length will measure ordered length

Outside Mount

- Fabric will measure ordered width
- Head rail* will measure ordered width plus: 3/16"
- Length will measure ordered length

* Head rail measurements include endcaps.
Width and length measurements may vary +/- 1/8"

NOTE: An additional 1/4" width deduction is taken on shades ordered Inside Mount with hold down brackets.

Prelude Cellular

STANDARD CORD LOCK SHADES

Applications

- Standard Rectangular
- Top Down - Bottom Up
- Two-On-One Head Rail

Things to Consider

- If child or pet safety is a concern, consider Cordless Ultra.
- Larger shades can be difficult to operate. Consider Cord Loop hardware.
- If privacy is an issue, consider Top Down-Bottom Up options.

Ordering Information for Standard Cord Lock Shades

Standard Rectangular

- Specify IB or OB mount, and left or right lift cord.

Top Down - Bottom Up

- Specify IB or OB mount.
Top Down - Bottom Up Shades are made with two operating cord locks, one on the left and one on the right side of shade. The right cord lowers the middle rail and left cord raises the bottom.
- On Top Down - Bottom Up Shades, an extra two-cell fabric gasket attached to the top head rail and acts as a seal to eliminate light leakage between the head rail and middle rail when the shade is closed.



Two-On-One Head Rail

Two-On-One Head Rail Shades operate as two separate shades on one head rail.

- Specify IB or OB mount.
- Specify panel sizes.
- Maximum width in a single panel depends on fabric type. See page 3 for maximum single panel width.
- ¼" to maximum ½" Space between panels.

Prelude Cellular CORD LOOP HARDWARE SYSTEM

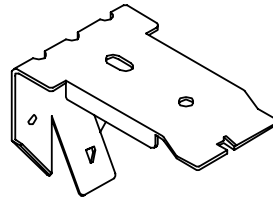

Standard Bracket

Prelude Hardware

Hardware Features	
Standard Hardware colors for Comfortex Prelude	Color coordinated head, middle, bottom rails and end caps with a white cord and tensioner
Upgrades	
Fabric Wrapped Upgrade	Fabric used is same fabric as the shade. Back of rail is white to outside. Color coordinated end caps for rails.
Designer Metallic Upgrade	<ul style="list-style-type: none"> • Smooth faced Oil Rubbed Bronze head, middle, bottom rails and end caps with bronze tensioner and bronze cord. • Smooth faced Brushed Nickel head, middle, bottom rails and end caps with coordinating tensioner and cord.

Mounting Dimensions	Cord Loop Hardware System
Minimum Inside Mount	3/4"
Minimum Flush Inside Mount	2 1/8"
Minimum Outside Mount Flat Vertical Surface	1 1/2"
Maximum End Mount Shade width 48"	

Finished Dimensions -Standard Rectangular and Top Down-Bottom Up	
Inside Mount	
	<ul style="list-style-type: none"> • Fabric will measure ordered width less: 3/8" • Head rail* will measure ordered width less: 1/4" • Length will measure ordered length
Inside Mount with Hold Down Brackets	
	<ul style="list-style-type: none"> • Fabric will measure ordered width less: 5/8" • Head rail* will measure ordered width less: 1/2" • Bottom rail* will measure ordered width less: 1/2" • Length will measure ordered length
Outside Mount	
	<ul style="list-style-type: none"> • Fabric will measure ordered width less: 1/8" • Head rail* will measure ordered width • Length will measure ordered length
* Head rail measurements include endcaps. Width and length measurements may vary +/- 1/8"	

NOTE: An additional 1/4" width deduction is taken on shades ordered Inside Mount with hold down brackets.

Prelude Cellular CORD LOOP HARDWARE SYSTEM

Finished Dimensions -Two-On-One	
Inside Mount	
	<ul style="list-style-type: none"> • Fabric will measure ordered width less: 5/8" • Head rail* will measure ordered width less: 1/4" • Length will measure ordered length
Outside Mount	
	<ul style="list-style-type: none"> • Fabric will measure ordered width less: 1/8" • Head rail* will measure ordered width • Length will measure ordered length
<p>* Head rail measurements include endcaps. Width and length measurements may vary +/- 1/8"</p>	

NOTE: An additional 1/4" width deduction is taken on shades ordered Inside Mount with hold down brackets.

Applications

- Standard Rectangular
- Top Down - Bottom Up
- Two-On-One Head Rail

Cord Loop Hardware System Features

Cord loops are available 18" to 10' lengths. Please specify length when ordering. Standard loop sizes are as follows:

Shade Length	Standard Loop
Up to 18"	18"
18" to 42"	2' (24")
42 1/8" to 54"	3' (36")
54 1/8" to 72"	4' (48")
72 1/8" to 90"	5' (60")
90 1/8" to 110"	6' (72")
110 1/8" and greater	8' (96")

Ordering Information for Cord Loop Hardware Shades

Standard Rectangular

- Specify IB or OB mount, and left or right lift cord.
- Specify cord loop length when ordering.

Top Down - Bottom Up

- Specify IB or OB mount.
Specify cord loop length when ordering.
- Controls are the right cord loop lowers the middle rail and left cord loop raises the bottom. Reverse controls are not available.

Two-On-One Head Rail

- Two-On-One Head Rail Shades operate as two separate shades on one head rail.
- Specify IB or OB mount.
- Specify panel sizes.
- Specify cord loop length when ordering.
- See page 3 for maximum single panel width.
- 1/4" Space between panels.

**Prelude Cellular
CORDLESS ULTRA HARDWARE SYSTEM**

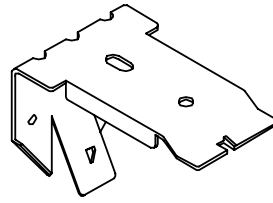

Standard Bracket

Prelude Hardware

Hardware Features	
Standard Hardware colors for Comfortex Prelude	Color coordinated head, middle and bottom rails.
Upgrades	
Fabric Wrapped Upgrade	Fabric used is same fabric as the shade. Back of rail is white to outside. End caps on fabric wrapped head, middle and bottom rails are color coordinated
Designer Metallic Upgrade	<ul style="list-style-type: none"> • Smooth faced Designer Oil Rubbed Bronze head, middle, bottom rails and end caps • Smooth faced Designer Brushed Nickel head, middle, bottom rails and end caps
Mounting Dimensions	
	Cordless Ultra Hardware System
Minimum Inside Mount	3/4"
Minimum Flush Inside Mount	2 1/8"
Minimum Outside Mount Flat Vertical Surface	1 1/2"
Maximum End Mount Shade width 48"	
Finished Dimensions	
Inside Mount	
	<ul style="list-style-type: none"> • Fabric will measure ordered width less: 3/8" • Head rail* will measure ordered width less: 1/4" • Length will measure ordered length
Inside Mount with Hold Down Brackets	
	<ul style="list-style-type: none"> • Fabric will measure ordered width less: 5/8" • Head rail* will measure ordered width less: 1/2" • Bottom rail* will measure ordered width less: 1/2" • Length will measure ordered length
Outside Mount	
	<ul style="list-style-type: none"> • Fabric will measure ordered width less: 1/8" • Head rail* will measure ordered width • Length will measure ordered length
Exact (End Cap to End Cap) Mount	
	<ul style="list-style-type: none"> • Fabric will measure ordered width less: 5/8" • Head rail* will measure ordered width less: 1/2" • Length will measure ordered length
* Head rail measurements include endcaps. Width and length measurements may vary +/- 1/8"	

NOTE: An additional 1/4" width deduction is taken on shades ordered Inside Mount with hold down brackets.

Prelude Cellular CORDLESS ULTRA HARDWARE SYSTEM

Applications

- Standard Rectangular
- Top Down - Bottom Up

Ordering Information for Cordless Ultra Hardware Shades

Standard Rectangular

- Specify IB or OB mount.

Top Down - Bottom Up

- Specify IB or OB mount.

Accessories

- 5' Expandable Pole: \$37.00



Specially designed pole end fits into the handle on the bottom rail and allows for easy operation.

Things to Consider

- Is the top of your window out of reach? You can order an extension pole to reach but it can still be tricky. You may want to consider Cord Loop hardware.
- For shades mounted on doors, you may want to order hold down brackets.
- If privacy is an issue, consider Top Down-Bottom Up options.



Prelude Hardware

Prelude Cellular CORDLESS LIFT & LOCK SHADES

Prelude Hardware

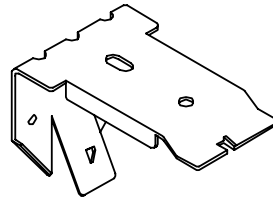

Standard Bracket

Hardware Features	
Standard Hardware colors for Comfortex Prelude	Color coordinated head, middle and bottom rails with color coordinated push button/handle on the middle and/or bottom rails
Upgrades	
Fabric Wrapped Upgrade	Fabric used is same fabric as the shade. Back of rail is white to outside. All shades will have a white push button/handle on the middle /bottom rail. White end caps.

Mounting Dimensions	Standard Head Rail
Minimum Inside Mount	3/4"
Minimum Flush Inside Mount	2 1/8"
Minimum Outside Mount Flat Vertical Surface	1 1/2"
Maximum End Mount Shade width 48"	

Finished Dimensions	
Inside Mount	
	<ul style="list-style-type: none"> Fabric will measure ordered width less: 3/8" Head rail* will measure ordered width less: 3/16"
Outside Mount	
	<ul style="list-style-type: none"> Fabric will measure ordered width Head rail* will measure ordered width plus: 3/16"
Exact (End Cap to End Cap) Mount	
	<ul style="list-style-type: none"> Fabric will measure ordered width less: 3/16" Head rail* will measure ordered width
* Head rail measurements include endcaps. Width and length measurements may vary +/- 1/8"	

NOTE: An additional 1/4" width deduction is taken on shades ordered Inside Mount with hold down brackets

Prelude Cellular CORDLESS LIFT & LOCK SHADES

Applications

- Standard Rectangular
- Top Down - Bottom Up

Ordering Information for Cordless Lift & Lock Hardware Shades

- Specify IB or OB mount and rail color.

Top Down - Bottom Up

- Specify IB or OB mount.

Things to Consider

- To operate a Cordless Lift & Lock Shade, the middle or bottom rails must be accessible. An extension pole is not available for Cordless Lift & Lock Shades.
- For shades mounted on doors, you may want to order hold down brackets.
- If privacy is an issue, consider Top Down-Bottom Up options.

Cordless Lift & Lock Shade Operation

Cordless Lift & Lock Shades are operated using the push button handle located in the center of the bottom rail.

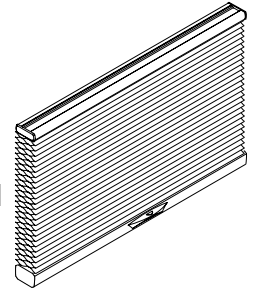

To raise or lower the shade; press the button on the shade handle, and guide the rail to desired position. Release the button to lock the shade into place.

The shade will hold in any position when the button is released. Raise the shade slowly and steadily to allow the shade to stack evenly.



Prelude Cellular

OVATION CELLULAR SLIDER

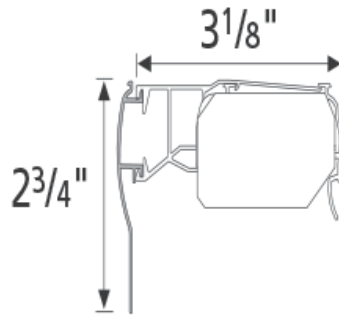

Ovation Hardware Rail Dimensions

- Depth of rail and bracket: 3 1/8"
- Valance Height: 2 3/4"
- For each spacer block 1/2" will be added to the length of the valance returns. For extension brackets, 2" will be added unless otherwise instructed.

Prelude Hardware

Hardware Features

Standard Hardware colors for Comfortex Prelude	Coordinating rail colors have been preselected for each fabric. More colorful fabrics are coordinated to white and off-white rail colors.
Ovation Valance	Every Ovation Slider comes with a painted aluminum valance. The valance attaches to the head rail using a durable plastic clip system.

Mounting Dimensions	Ovation Hardware System
---------------------	-------------------------

Minimum Inside Mount, Installation Bracket	1 5/16"
Minimum Flush Mount	3 5/8"
Minimum Outside Mount	5/8"

Mounting Specs	<ul style="list-style-type: none"> • For each spacer block, 1/2" will be added to the length of the valance returns. For extension brackets, 2" will be added unless otherwise instructed. • Specify Inside Mount (IB) or Outside Mount (OB) when ordering. If the slider requires a non-flush inside mount, you must order a custom valance. • Exact valance width and exact valance return length (minimum 1 1/2") must be specified in the Special Instructions section of the order form.
-----------------------	--

Finished Dimensions

Inside Flush Mount

Track Width:	
Right or Left Stack	3/16" less than ordered width
Split Stack	3/16" less than ordered width
Center Stack	3/16" less than ordered width
Finished Slider Length	1/2" less than ordered width
Valance	3/16" less than ordered width

Outside Mount

Track Width	3/16" less than ordered width
Finished Slider Length	Ordered length - No reductions will be made
Valance	Ordered width plus 1"
Valance Returns	Will measure 3 1/8" (standard)

Prelude Cellular

OVATION CELLULAR SLIDER

Applications

- Standard Rectangular
- Opens and closes from side to side
- Four stacking options - see below.

Ovation Stacking Width

Width	up to 84"	up to 96"	up to 108"	up to 120"
Stack	6½"	7¼"	8"	8¾"

Minimum Ovation Stack

Ovation's fabric stack measures 6½" regardless of the ordered width. Fabric stacking dimensions are determined by the slider's hardware, not ordered width.

Things to Consider

- Since most Ovations are sold in large sizes, the shade will have a large fabric stack. On an outside mount, you may want to order the shade a few inches wider so that the fabric stack can be clear of the window.

Ordering Information for Ovation Cellular Sliders

- Specify IB or OB mount.
- Specify stacking configuration. On Split Stack Shades, both panels will be of equal width unless specified.
- Specify valance width and return length.

Ovation Valance Specifications

- Every Ovation Slider is supplied with a painted aluminum valance.
- The valance attaches to the head rail using a durable plastic clip system.

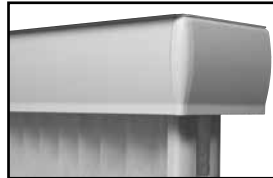

Ovation Valance Dimensions

All valance dimensions are measured on the flat, back side.

- Valance Height: 2¾"
- Standard Return Length (OB only): 3⅛"
- For each spacer block, ½" will be added to the length of the valance returns. For extension brackets, 2" will be added unless otherwise instructed.

Vertical Stacking Options

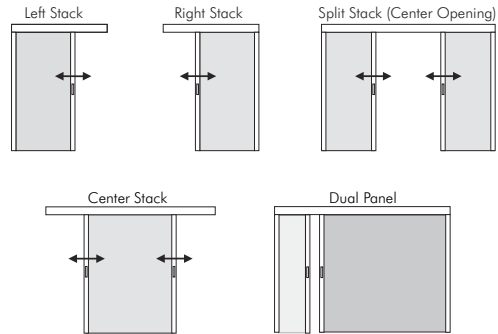

Specify stacking configuration when ordering.

Left: Fabric stacks to the left side of the slider.

Right: Fabric stacks to the right side of the slider.

Center Stack: Center Stack Sliders fabric panels can move fully to the left or the right.

Split Stack: Fabric is split in the center of the slider forming two equal panels which open to opposite ends of the slider. Both panels will be of equal width unless otherwise specified.



Prelude Cellular STARBURST ARCHES

Stationary Starburst

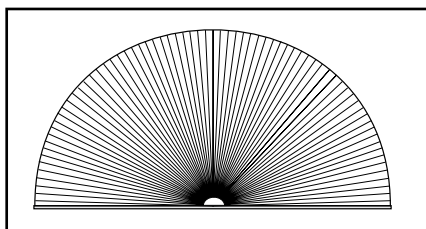

Figure A

Movable Starburst

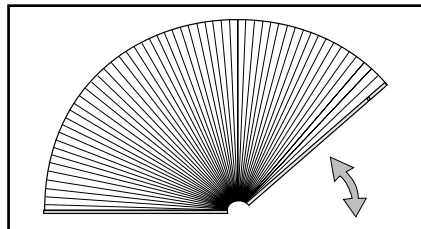

Figure B

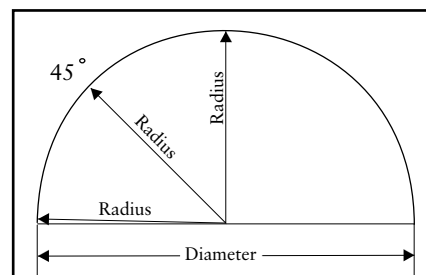

Figure C

Prelude Hardware

Hardware Features	
Standard Hardware colors for Comfortex Prelude	Color coordinated rails
Mounting Dimensions	
Minimum Shallow Mount	3/4"
Minimum Flush Inside Mount	2 3/8"
Recommended Side Mounting Method	• Width limit for side mount brackets is 48"
Finished Dimensions	
Inside and Side Mount	
<ul style="list-style-type: none"> Fabric will measure ordered width less: 3/8" Head rail* will measure ordered width less: 3/16" 	<ul style="list-style-type: none"> * Head rail measurements include endcaps. Width and length measurements may vary +/- 1/8"

Applications

- Stationary Fan Style Arch
 - Movable Fan Style Arch
- Movable Starburst Arch shades are for inside and shallow mount applications only.

Stationary Starburst Features (Figure A)

- **All non-perfect Stationary Starburst arches require a template.** See page 134 to for template instructions.
- **All templates should be made from brown craft paper.** Comfortex offers template kits. Please contact Customer Service to order. Stock number: 751000
- A perfect arch is twice as wide as it is high.
- Stationary Starburst shades which are not perfect half circles must have a height that equals half the width +/- 5".
- Price according to the largest radius measurement. If the height is greater than the width, take height X 2 and use that number to determine pricing.
- When ordering arches as perfect half-circles make sure the radius of the arch remains constant to ensure a proper fit. (See Figure C)

Movable Starburst Features (Figure B)

- Starburst Movable archttop shades are cut to perfect half circles only and do not require a template. The height must be exactly 1/2 the diameter.
- A perfect arch is twice as wide as it is high.
- When ordering arches as perfect half circles make sure the radius of the arch remains constant to ensure a proper fit. (See Figure C)
- The hinge gap (gap between the two rails) is not centered in the window. The moving rail is always smaller than the stationary rail to provide proper movement within the window.

Ordering Information for Sunset Shades

- Specify IB mount and rail color.
- Include a template if the shade is a non-perfect arch.

Accessories

- 6' Expandable Pole: \$37.00

Specially designed pole end fits into the handle on movable Starburst Shades for easy operation.



Prelude Cellular SUNSET ARCHES

Movable Sunset

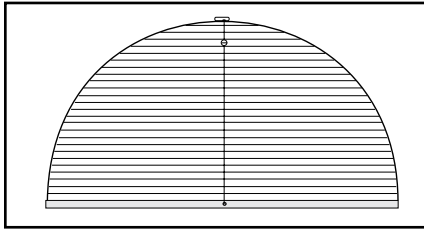

Figure A

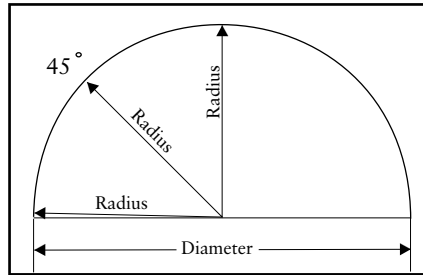

Figure B

Two-String Hanging Method

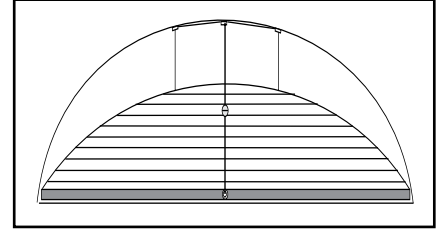

Figure C

Hardware Features | See Page 102 for Rail Dimensions

Hardware colors for all Prelude	Color coordinated head, middle and bottom rails with white cord and silver tassel
Mounting Dimensions	
Minimum Shallow Mount	3/4"
Minimum Flush Inside Mount	2 3/8"
Minimum Outside Mount	3/4"
Minimum Side Mount	1 3/8"
Minimum Flush Side Mount	1 7/8"
Recommended Side Mounting Method	<ul style="list-style-type: none"> • See page 114 for recommended mounting method for side mount shades • Width limit for side mount brackets is 48"
Finished Dimensions	
Inside and Side Mount	
	<ul style="list-style-type: none"> • Fabric will measure ordered width less: 3/8" • Head rail* will measure ordered width less: 3/16"
Outside Mount	
	<ul style="list-style-type: none"> • Fabric will measure ordered width • Head rail* will measure ordered width plus: 3/16"
* Head rail measurements include endcaps. Width and length measurements may vary +/- 1/8"	

Applications

- Movable Arch

Ordering Information for Sunset Shades

- Specify IB or OB mount and rail color.
- Include a template if the shade is a non-perfect arch.

Accessories

- 6' Expandable Pole: \$37.00

Specially designed pole end fits into the ball on Sunset Shades for easy operation.



Prelude Cellular SUNSET ARCHES

Sunset Features and Ordering Notes (Figure A)

- Sunset shades have horizontal pleats that stack at the bottom, on a stationary sill rail. Sunset shades are operated by a continuous cord that runs through a top mount guide block and back down through the stationary rail. A moving metal ball attached to the cord is used to raise and lower the shade. (See Figure D).
- **All Sunset arches require a template.** A perfect arch is twice as wide as it is high. See page 134 for template instructions.
- **All templates should be made from brown craft paper.** Comfortex offers template kits. Please contact Customer Service to order. Stock number: 751000
- Sunset shades which are not perfect half circles must have a height which is equal to or greater than 25% of the width.
- When ordering Sunset shades that are perfect half circles, make sure the radius of the arch remains constant to ensure a proper fit. (See Figure B).
- **Stringing Method:** Depending on the curvature of a particular arch, it may be necessary to use the two string method (See Figure C) to ensure proper fit and operation of your Sunset shade. Comfortex will determine the best stringing method after examination of the template.

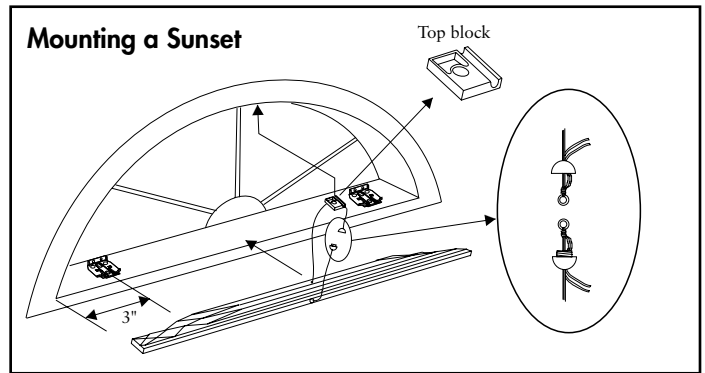

Figure D

Recommended Mounting Method for Side Mounting Shades

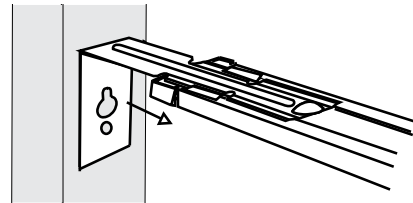

Figure F

Refer to the installation instructions on Comfortexdealers.com or the OnDemand Mobile Library for further details on side mounting shades.



Prelude Cellular QUARTER ROUNDS

Stationary Quarter Round

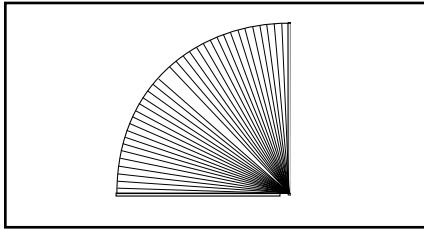

Figure A

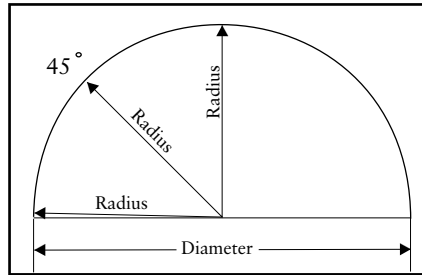

Figure B

Hardware Features	
Hardware colors for all Cellular and Pleated fabrics	Color coordinated rails
Mounting Dimensions	
Minimum Shallow Mount	3/4"
Minimum Flush Inside Mount	2 3/8"
Minimum Outside Mount	3/4"
Minimum Side Mount	1 3/8"
Minimum Flush Side Mount	1 7/8"
Recommended Side Mounting Method	<ul style="list-style-type: none"> • See page 114 for recommended mounting method for side mount shades • Width limit for side mount brackets is 48"
Finished Dimensions	
Inside and Side Mount	
	<ul style="list-style-type: none"> • Fabric will measure ordered width less: 3/8" • Head rail* will measure ordered width less: 3/16"
Outside Mount	
	<ul style="list-style-type: none"> • Fabric will measure ordered width • Head rail* will measure ordered width plus: 3/16"
Exact (End Cap to End Cap) Mount	
	<ul style="list-style-type: none"> • Fabric will measure ordered width less: 3/16" • Head rail* will measure ordered width
* Head rail measurements include endcaps. Width and length measurements may vary +/- 1/8"	

Applications

- Stationary Fan Style Quarter Round

Ordering Information for Quarter Rounds Shades

- Specify IB or OB mount and rail color.

Quarter Rounds Features

- Price according to the largest radius measurement.
- **All templates should be made from brown craft paper.** Comfortex offers template kits. Please contact Customer Service to order. Stock number: 751000
- When ordering arches as perfect quarter circles, make sure the radius of the arch remains constant to ensure a proper fit. (See Figure B)

Prelude Cellular TRAPEZOIDS AND OCTAGONS

Movable Trapezoids

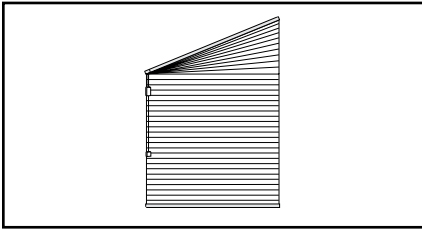

Movable Octagons

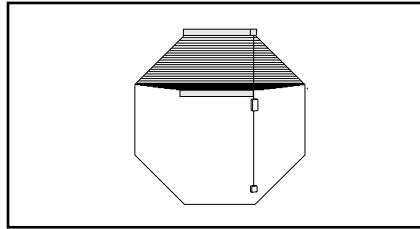

Prelude Hardware

Hardware Features See Page 102 for Rail Dimensions	
Standard Hardware colors for Comfortex Prelude	Color coordinated head and bottom rails with white cord and tassel
Mounting Dimensions	
Mounting Dimensions	Standard Rail
Minimum Shallow Mount	3/4"
Minimum Flush Inside Mount	2 3/8"
Minimum Outside Mount	3/4"
Minimum Side Mount	1 3/8"
Minimum Flush Side Mount	1 7/8"
Recommended Side Mounting Method	<ul style="list-style-type: none"> • See page 114 for recommended mounting method for side mount shades • Width limit for side mount brackets is 48"
Finished Dimensions	
Inside and Side Mount	
	<ul style="list-style-type: none"> • Fabric will measure ordered width less: 3/8" • Head rail* will measure ordered width less: 3/16"
Outside Mount	
	<ul style="list-style-type: none"> • Fabric will measure ordered width • Head rail* will measure ordered width plus: 3/16"
Exact (End Cap to End Cap) Mount	
	<ul style="list-style-type: none"> • Fabric will measure ordered width less: 3/16" • Head rail* will measure ordered width
* Head rail measurements include endcaps. Width and length measurements may vary +/- 1/8"	

Applications

- Movable Trapezoids
- Movable Octagons

Ordering Information for Trapezoid Shades

- Specify IB or OB mount and rail color.
- **Trapezoid orders must be faxed in with a diagram. Please provide measurements for all four sides when ordering.**

Ordering Information for Octagon Shades

- Specify IB or OB mount and rail color.
- **The width, length and one side are required measurements when ordering.**

Prelude Cellular TRAPEZOIDS AND OCTAGONS

Trapezoids (Figure A)

- Trapezoid orders must be faxed in with a diagram. Please provide measurements for all four sides when ordering. Template is required.
- The maximum slope of the top rail is 30 degrees from horizontal. Slope is the angle between slope and a horizontal line. The slope angle must be measured with a protractor.
- Sides of trapezoid must be parallel.
- Sill must be level for proper installation and operation of a trapezoid shade.
- Operating cord must be placed on the short side.
- See Figure B for trapezoid shade operation.

Octagons

- The width, length and one side are required measurements when ordering.
- Octagon shades raise only to the point where the top angle begins. (See Figure C)

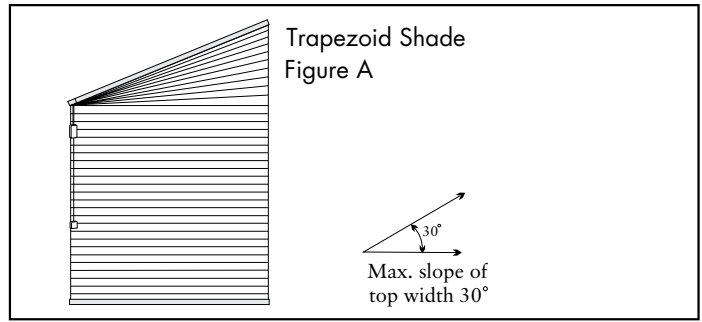

Trapezoid Shade Operation

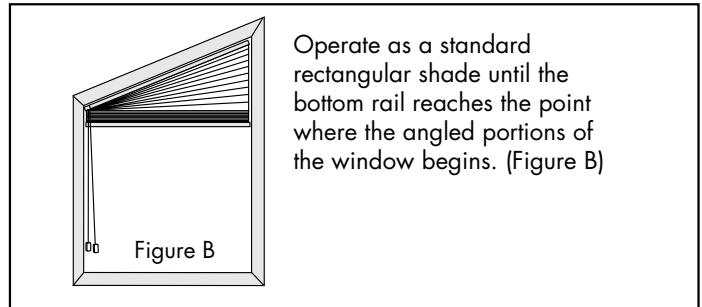

Octagon Operation

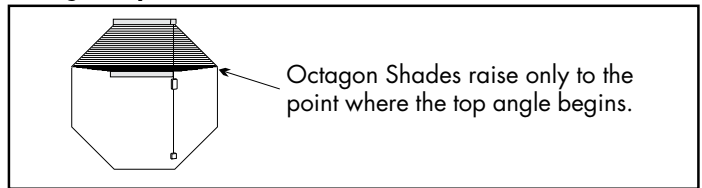
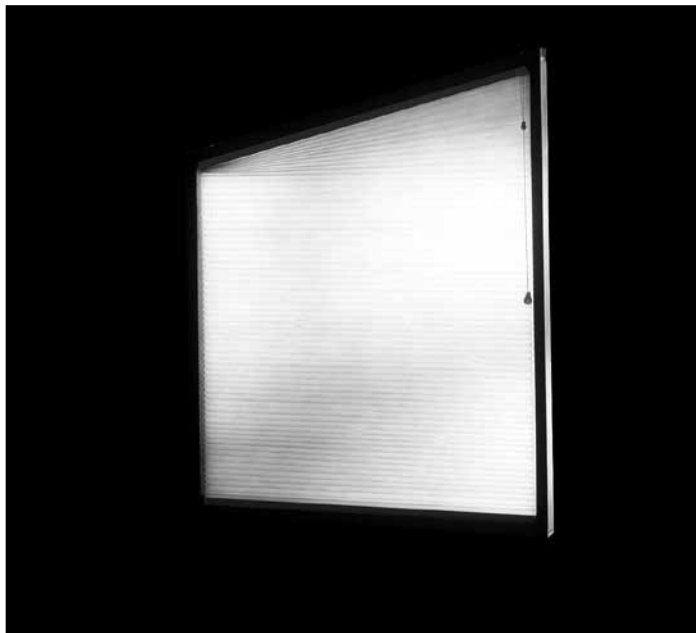
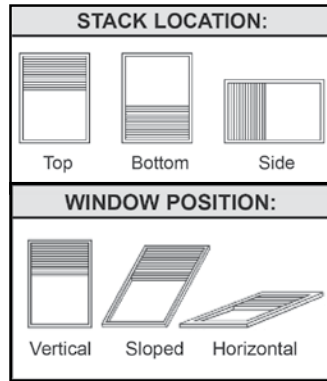
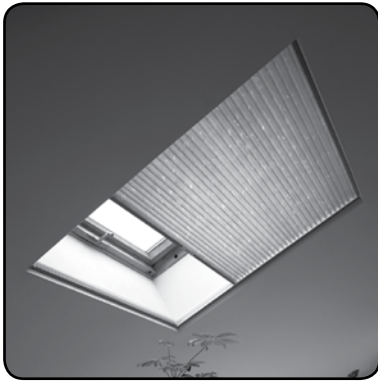

Figure C



Prelude Cellular SKYLIGHT SHADING SYSTEM



Skylight Vertical Applications

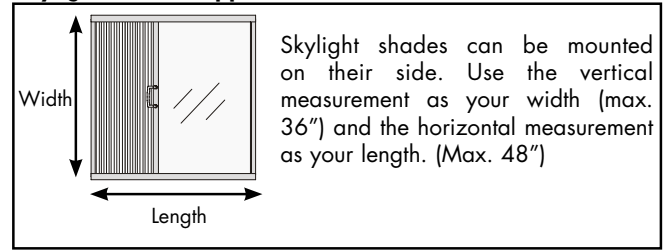

Figure A

Prelude Hardware

Hardware Features

Standard Hardware colors for Comfortex Prelude	White head and bottom rails with white cord in a white sidetrack.
--	---

Upgrades

Fabric Wrapped Upgrade	Not Available
Designer Metallic Upgrade	Not Available

Mounting Dimensions - Inside Only

Skylight Shading System

Minimum required for installation	1 1/4"
Minimum Flush Inside Mount (Rail Fully Recessed)	2 1/2"

The widest width of the window cannot exceed the narrowest width of the window by more than 3/8".

Finished Dimensions

Inside Mount

- Fabric will measure ordered width less: 3/4"
- Head rail* will measure ordered width less: 3/16"

* Head rail measurements include endcaps. Width and length measurements may vary +/- 1/8"

Applications

- Horizontal, Angled and Vertical rectangular windows and skylights. Skylight Shading Systems are for inside mount applications only.

Ordering Information for Skylight Shading System

- Specify when ordering: Application angle: Angled, Horizontal or Vertical.

Accessories

- 6' Expandable Pole: \$37.00



Specially designed pole end fits into the handle of Skylight shades for easy operation at any angle.

Skylight Shading System Features

- Shades can be mounted on their side. (See Figure A). Use the vertical measurement as your width (max. 36") and the horizontal measurement as your length (max. 48").
- Track system provides superior insulation and light blocking. The enclosed sides provide full privacy.
- Shades over 30" wide require support cords.
- Fabric gasket attached to moving rail to eliminate light leakage when shade is closed.

**Prelude Cellular
SIMPLICITY MOTORIZED CELLULAR SHADES**

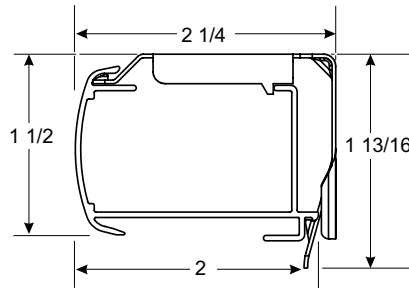

Simplicity Motorized Rail Dimensions

- Depth of rail: 2"
- Depth of rail and bracket: 2 1/4"
- Height of rail: 1 1/2"
- Height of bracket: 1 13/16"

Hardware Features	
Standard Hardware colors for Comfortex Prelude	Color coordinated head, middle, bottom rails and end caps
Simplicity Remote	Upper and lower limit stops pre-programmed. "Favorites" position can be set on-site.
Upgrades	
Fabric Wrapped Upgrade	Fabric used is same fabric as the shade. Back of rail is white to outside. End caps on fabric wrapped rails are color coordinated
Designer Metallic Upgrade	<ul style="list-style-type: none"> • Smooth faced Oil Rubbed Bronze head, middle, bottom rails and end caps • Smooth faced Brushed Nickel head, middle, bottom rails and end caps

Mounting Dimensions	Simplicity Motorized Hardware System
Minimum Shallow Mount	1"
Minimum Flush Inside Mount	2 1/4"
Minimum Outside Mount	7/8"
Minimum Side Mount	1 1/4"
Minimum Flush Side Mount	2 1/4"
Recommended Side Mounting Method	• Width limit for side mount brackets is 48"

Finished Dimensions	
Inside Mount	
	<ul style="list-style-type: none"> • Fabric will measure ordered width less: 3/8" • Head rail* will measure ordered width less: 3/16"
Outside Mount	
	<ul style="list-style-type: none"> • Fabric will measure ordered width • Head rail* will measure ordered width plus: 3/16"
Side Mount	
	<ul style="list-style-type: none"> • Fabric will measure ordered width less: 7/8" • Head rail* will measure ordered width less: 1 1/16"
Exact (End Cap to End Cap) Mount	
	<ul style="list-style-type: none"> • Fabric will measure ordered width less: 3/16" • Head rail* will measure ordered width
* Head rail measurements include endcaps. Width and length measurements may vary +/- 1/8"	

Prelude Hardware

Prelude Cellular SIMPLICITY MOTORIZED CELLULAR SHADES

Applications

- Standard Rectangular

Simplicity Motorization Surcharges

The standard Simplicity Motorized Lift System surcharge includes a 12 volt battery wand with eight AA batteries. Remotes are needed to operate the shades.

Important Simplicity Motorized Shade Operating and Installation Information

- Simplicity Motorized Shades installed into windows with metal casings may have a reduced radio frequency range, or may not operate at all, depending on the application.
- Do not let the antenna on the motor touch any metal objects. This may interfere with signals from the remote control.

Ordering Information for Motorized Cellular Shades

Simplicity Motor Option

- Specify IB or OB mount and rail color.
- Specify remote and other accessories if needed.

Motorized Cellular Blinds Warranty Simplicity Motors

See page 138

Simplicity Battery Wand

Batteries are needed to operate Simplicity motors. The battery wand can be clipped to the head rail or wall or ceiling mounted utilizing white battery wand clips. The 12 volt battery wand measures 17¼", and comes with eight AA alkaline batteries, and is white in color.

The battery wire is 10" long. A 48" extension wire is available.



Simplicity Motor Battery Life and Replacement

Eight alkaline batteries are included with the wand. The battery life will vary based on the type of window covering selected, the size and weight of the window covering and the number of times you operate the shade on a daily basis. For example, a 36" x 60" single honeycomb shade operated twice daily typically will have a battery life which lasts up to 18 months.

Comfortex will warranty batteries for up to 3 months from date of purchase.

Simplicity Hand Held Remotes

The 5 Channel remote can operate up to five shades individually or 5 groups. **WHEN ORDERING PLEASE SPECIFY WHICH CHANNELS ARE ASSIGNED TO EACH SHADE OR GROUP OF SHADES.** For example; program line 1 to channel 1, line 2 and 3 to channel 2, etc. If no channels are assigned at time of order, all shades will be programmed to Channel 1. **To reprogram channel assignments, please refer to the installation instructions and/or view the video at comfortexdealers.com/products/motortechsupport.html.**



Simplicity remotes and holders are black in color. The remote comes with a holder which can be mounted to a wall for easy storage. The range of the remote is approximately 80 feet.

The 5C Simplicity remote utilizes one 3V battery (CR2032). Batteries are included. Comfortex will warranty batteries for up to 3 months from date of purchase.

DC Power Supply/Transformer

12 Volt DC power supply/transformer is available and requires a standard power outlet to power the motor. The transformer is an alternative to a battery wand. Each transformer can power a single shading. The power supply must plug in to the motor. The DC power supply is white and comes with a 80" wire. The dimensions are 1⅞" wide x 3¼" long x 1¼" deep



Prelude Hardware

Cellular Shade Options HIGHLIGHTS CORNICE VALANCE



Highlights Cornice Valances

Elevate your windows to a whole new level of design with the Highlights Cornice Valance. Coordinate with other design elements in your room. Add a finishing touch to the top of any window treatment.

The Highlights Cornice Valance is versatile and beautiful at a price point that won't leave you wondering how to cover the rest of your windows!

Choose from any fabric in our Envision™ and PERSONA™ line and customize the valance with our 7 available return sizes to best fit your application.

Easy assembly and quick installation, with the Highlights Cornice Valance, more beautiful windows are within your reach.

Refer to your Envision price list for pricing and specifications.

Fabric Characteristics

Natural Linen Flax Cellular Fabric Characteristics

Natural Linen Flax fabrics are sheer and are created from flax fibers which allow the most amount light into the room. Interior shade cords and objects in the room may be clearly seen through the shades.

Variations in the fabric weave, slubs, and texture are all enhancements that add to the natural beauty and character of the shade; therefore no two shades will look exactly the same.

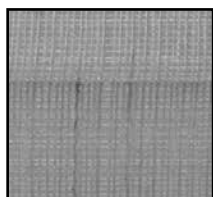

Weave

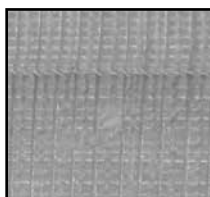

Slub

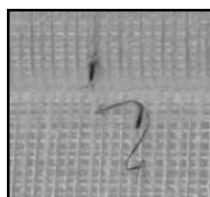

Texture

Cut-Outs

Cut-outs are available with all cellular fabrics. Cut-outs are \$52.00 per side and are subject to approval by the Comfortex Technical Service department.

There are no limits on cut out lengths. There are limits on cut out widths:

Cellular shade widths 18" or less	3" maximum width
Cellular shade widths greater than 18"	5" maximum width
Pleated shades	2" maximum width

Scotchgard™ and Certified Fabrics

Scotchgard Protection

Scotchgard™ Protector is available with all cellular Shades. Scotchgard™ keeps your shades looking newer, fresher and cleaner longer.



A combination of the latest advances in stain release and repellency provides exceptional stain protection. Spills wipe away easily and most dirt and stains lift out when cleaned. Both sides of the fabric are treated with Scotchgard.

Greenguard Certified Fabrics

GREENGUARD Indoor Air Quality Certified® Fabrics
The GREENGUARD Environmental Institute has established performance based standards to define goods with low chemical and particle emissions for use indoors.

The following fabrics have the passed GREENGUARD Indoor Air Quality Certified® certification program for low emitting interior building materials, furnishings, and finish systems:

- Symphony (All)
- Virtuoso (All)
- Baritone (All)
- Premiere (All)
- Natural Linen Flax
- Debut (All)
- Silk Essence
- Linen Weave

The following fabrics have the passed GREENGUARD Children & Schools™ product certification program for low emitting interior building materials, furnishings, and finish systems used in educational (day care and K-12) environments:

- Symphony Light Filtering
- Symphony Blackout

Symphony Flame Resistant Fabrics

Symphony Flame Resistant Fabrics have been registered as a Flame Resistant Products by the California State Fire Marshall for products identified in section 13115, California Health and Safety Code (California CHSC). Copies of the certificates are located on the Comfortexdealers.com web site or on the On Demand Mobile library.

Color Selection

Use the current Cellular Shades Collection sample book to select colors from the Symphony light filtering fabric collection. All thirty colors are available in 3/8" Symphony light filtering double cell and 3/4" light filtering single cell.

Ordering Flame Resistant Shades

The SKU structure for Symphony Flame Resistant material is: 3012 05 XXX (XXX representing the color number).

To order Symphony Flame Resistant Shades: Use the SKU number listed on the decks.

The SKU structure for the 3/4" Symphony Flame Resistant material is: 2512 05 XXX

To order 3/4" Symphony Flame Resistant Shades:

Use the Symphony three digit color number to identify your desired color.

In this example:
2512 05 108



EZ Level on Comfortex Cellular Shades

EZ Level makes quick work of leveling without cords to cut or tuck into a rail. No special tools needed – just use a nickel, quarter or penny to adjust plug on the bottom rail.

EZ Level is standard on all Cellular and Pleated Shades with the following hardware systems:

- Standard and Deluxe Cord Lock
- Cordless Ultra
- Cord Loop
- SlumberShades
- Simplicity Motorized Systems

EZ Level is not available with Lift & Lock Cordless.

How does EZ Level work?

- Slightly raise the bottom rail you want to level.
- Insert a coin or flat head screwdriver into the adjustment screw and turn it.
- Turn the adjustment screw clockwise or counter clockwise to make slight adjustments up or down.



One quarter turn of the adjustment screw will move the bottom rail up or down 1/4".

- Lower the rail to check the level and make further adjustments if necessary.

Cleaning and Care

While beautiful and pleasing to the eye, all Comfortex products are designed to be durable, easily cared for and easily cleaned. Our non-woven fabrics are inherently anti-static and repel dust, but occasional feather dusting or vacuuming may be necessary to keep the fabrics clean and bright. Comfortex Cellular fabrics may be ultrasonically cleaned.

Cleaning Virtuoso Blackout, Baritone Blackout and Symphony Blackout Fabrics: Our blackout fabrics are inherently anti-static and repel dust, but occasional cleaning may be necessary to keep the fabrics clean and bright. The fabric can be dusted with a soft, clean cloth, feather duster or lightly vacuumed with a soft brush attachment. To spot clean, use a cloth or sponge dipped in a light solution of lukewarm water and clear dish detergent and lightly dab. Do not scrub the surface. Rinse thoroughly.

Cleaning all other Comfortex Cellular or Pleated Fabrics:

Our light filtering and room darkening fabrics are inherently anti-static and repel dust, but occasional cleaning may be necessary to keep the fabrics clean and bright. The fabric can be dusted with a soft, clean cloth, feather duster or lightly vacuumed with a soft brush attachment. Spills and stains can be lightly blotted with a cloth or damp sponge. More difficult stains may require soaking in water with mild soap. For this, remove the shades from the window and soak in warm water. Complete immersion of hardware is not recommended.

DO NOT submerge the Cordless Ultra head rail in water. When damp, lay flat to dry or place back in window and raise tightly to recrisp pleats. Please test any stronger cleaners on an unobtrusive portion of the shade before using.

For additional advice on care or cleaning, please contact our Technical Services Department.

Scotchgard™ Treated Shades

The following are the recommended cleaning and care instructions for window treatments with fabric treated with Scotchgard™ Protector.

- Gently blot liquid stains immediately with a clean, white cloth.
- If stain remains, prepare a solution of ¼ teaspoon of clear, non-bleaching dish detergent mixed with 1 cup of lukewarm water. Dampen a clean white cloth and gently blot the stain.
- Do not overwet the fabric or excessively rub the stained area.
- See the Installation and Care instructions for complete details.



For additional assistance with stain removal, call the Scotchgard™ Protector Service Center at 1-800-433-3296. Customer Care representatives are available Monday through Friday, 8am to 6pm CT.

Odysee Cellular Blinds

Odysee Cellular Blinds



Odysee Cellular Blinds Hardware Options

	Key Features	Color Options	Hardware Size (Depth x Height)	Shade Size Available	More Information
<p>Cord Loop</p> 	<ul style="list-style-type: none"> • Integrated clutch locking system • Cord Loop makes operation easy • Smooth & quiet operation 	<ul style="list-style-type: none"> • White Head & Bottom Rails • Color matched fabric head rail insert strip 	<p>Head Rail: 2$\frac{5}{8}$" x 2$\frac{1}{8}$"</p> <p>Bottom Rail: 1$\frac{3}{4}$" x $\frac{1}{4}$"</p>	<p>Width: 20" to 108"</p> <p>Length: 12" to 120"</p>	Page 127
<p>Simplicity Motorization</p> 	<ul style="list-style-type: none"> • Raise & lower shade with a click of a button • Great for large and hard to reach windows • Remote can operate multiple blinds 	<ul style="list-style-type: none"> • White Head & Bottom Rails • Color matched fabric head rail insert strip 	<p>Head Rail: 2$\frac{5}{8}$" x 2$\frac{1}{8}$"</p> <p>Bottom Rail: 1$\frac{3}{4}$" x $\frac{1}{4}$"</p>	<p>Width: 20" to 96"</p> <p>Length: 12" to 96"</p> <p>Maximum Area: 50 Sq. Ft.</p>	Page 130
<p>PowerTouch™ Cordless Motorized Wand</p> 	<ul style="list-style-type: none"> • Child safe • Eliminate the need to stand by the shade to operate; just touch and go • Raise & lower shade with a click of a button 	<ul style="list-style-type: none"> • White Head & Bottom Rails • Color matched fabric head rail insert strip 	<p>Head Rail: 2$\frac{5}{8}$" x 2$\frac{1}{8}$"</p> <p>Bottom Rail: 1$\frac{3}{4}$" x $\frac{1}{4}$"</p>	<p>Width: 20" to 72"</p> <p>Length: 12" to 84"</p>	Page 129

Odysee Cellular Blinds

Odysee Cellular Blinds Features at a Glance

- Odysee Insulating Blinds provide the same energy saving benefits as classic cellular shades, but with the enhanced versatility of fully functional vanes.
- The Odysee vanes expand and compress to create several innovative views. Expanded vanes offer complete privacy, energy efficiency and hidden lift cords. Compressed vanes provide variable light control and substantial view through -like a wood blind.
- All Odysee Blinds are built with a cord loop system as standard.
- Odysee vanes are available with light filtering or room darkening fabric.
- Odysee provides the convenient operation of a blind with soft fabric look of a shade.
- All Odysee vanes are white to the outside for a uniform exterior appearance.
- A limited lifetime warranty serves as a commitment to your satisfaction.

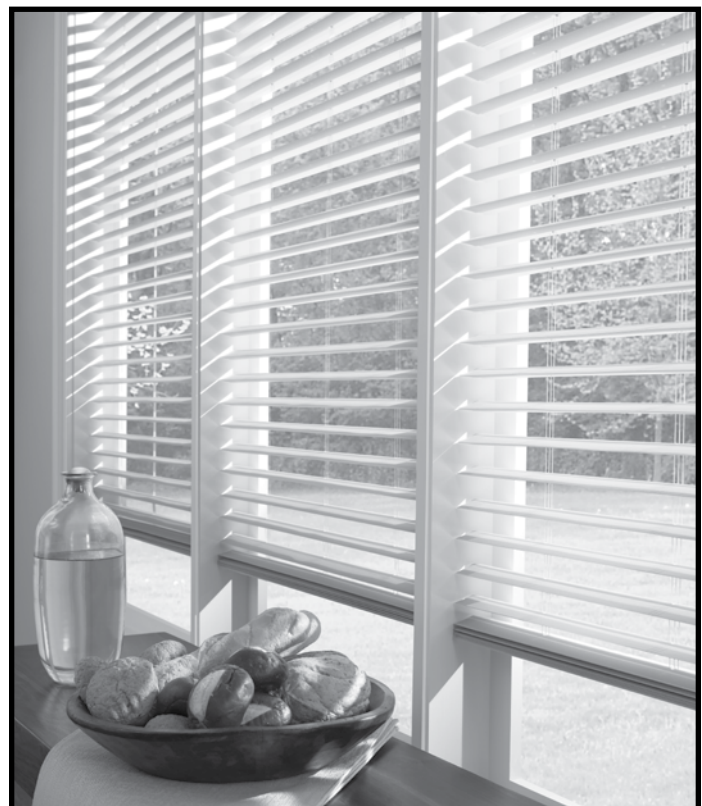

Odysee Cellular Blinds
Separate Discount Applies

Price Group 48
Cord Loop System - Light Filtering

		Width In Inches														
		24	30	36	42	48	54	60	66	72	78	84	90	96	102	108
Length In Inches	36	325	366	414	466	514	551	601	652	698	745	793	839	895	946	999
	42	351	399	452	514	563	617	669	727	779	833	889	942	999	1058	1119
	48	369	429	489	548	608	664	726	782	845	902	958	1022	1086	1150	1217
	54	389	450	516	583	652	709	776	843	903	967	1030	1101	1169	1239	1310
	60	424	485	560	626	700	773	841	910	982	1057	1129	1199	1271	1347	1422
	66	449	519	598	674	755	833	905	984	1062	1144	1222	1309	1381	1464	1546
	72	470	543	629	723	800	874	969	1040	1129	1210	1292	1394	1469	1556	1644
	78	501	583	674	768	860	935	1021	1115	1205	1295	1386	1480	1575	1670	1763
	84	521	617	709	809	905	988	1081	1180	1277	1380	1472	1567	1667	1767	1868
	90	546	645	752	849	957	1044	1148	1254	1356	1461	1562	1669	1774	1880	1986
	96	568	674	781	892	1007	1096	1204	1314	1422	1532	1643	1755	1868	1978	2092
	102	652	753	850	962	1062	1149	1282	1406	1504	1603	1706	1851	1954	2072	2187
108	686	793	896	1012	1117	1208	1346	1478	1583	1694	1794	1934	2038	2161	2284	
114	727	839	952	1074	1191	1283	1427	1567	1679	1791	1905	2050	2162	2291	2421	
120	779	899	1021	1148	1268	1374	1526	1679	1797	1916	2039	2195	2317	2454	2590	

☐ Simplicity Motorized Lift System is not offered within the shaded area.

Odysee Cellular Blinds

LIFT SYSTEM AND DESIGN UPGRADES		ADD
Solid Colors and Natural Texture Collection Fabrics	Light Filtering	Grid 48
	Room Darkening	10% to Grid 48
Personal Color System Fabrics	Light Filtering	10% to Grid 48
	Room Darkening	10% to Grid 48 PLUS 10%
MOTORIZATION		MORE INFO
Cordless PowerTouch - Wand and Batteries		Pg 129
Custom PowerTouch Wand length		\$103 Per Blind
Simplicity - Motor and Battery Wand (excludes remote)		Pg 129
Simplicity 5 Channel Remote		\$31
Simplicity 6 Channel Remote with Timer		Pg 130
DC Power Supply/Transformer		\$368
		Pg 130
		\$91
		Pg 130
		\$110
		Pg 130
		\$77

Odysee Cellular Blinds HARDWARE SYSTEM

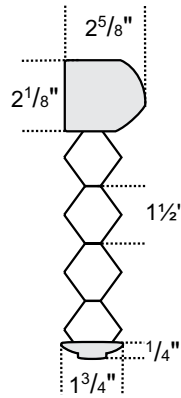
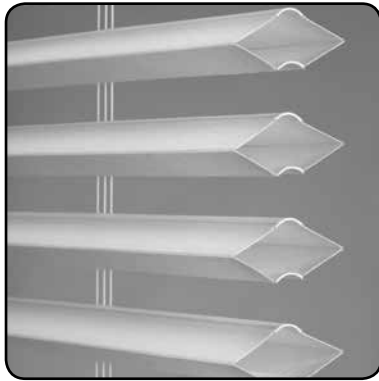

Odysee Cellular Blind Rail Dimensions

- Depth of head rail: 2 5/8"
- Height of head rail: 2 1/8"
- Height of cell: 1 1/2"
- Depth of bottom rail: 1 3/4"
- Height of bottom rail: 1/4"

Hardware Features	
Hardware colors for all Odysee Cellular Blinds	<ul style="list-style-type: none"> • White head rail and bottom rail. The head rail includes a color matched fabric head rail insert strip. • Operating cord and cord tensioner are white. • There may be a gap from the head rail to the top vane (when the vanes are fully expanded) could be up to 3/16". The lip on the back of the head rail will prevent "view through" to the outside.
Mounting Dimensions	
Odysee Cellular Blind Hardware System	
Inside Mount	
Minimum Shallow Mount	1 1/4"
Minimum Flush Inside Mount	2 7/8"
Minimum Rear Vane Clearance	1/8"
Outside Mount	
Minimum Shallow Mount	1"
Minimum Flush Inside Mount	2"
Minimum Outside Mount	1/8"
Side Mount	
Minimum Shallow Mount	1 1/2"
Minimum Flush Inside Mount	2 5/8"
Minimum Outside Mount	1/8"
Finished Dimensions	
Odysee Cellular Blind Hardware System	
Inside Mount	
	<ul style="list-style-type: none"> • Head rail* unit ordered width less: 3/16" • Blind length up to 1 5/8" more than ordered length; bottom vane may not fully extend when blind is fully lowered • Fabric width ordered width less 1/2"
Outside Mount	
	<ul style="list-style-type: none"> • Head rail* unit ordered width less: 3/8" • Blind length up to 1 5/8" more than ordered length • Fabric width ordered width
* Head rail measurements include endcaps. Width and length measurements may vary +/- 1/8"	

Odysee Cellular Blinds

Odysee Cellular Blinds HARDWARE SYSTEM

Applications

- Standard Rectangular

Fabric Collections

You can select fabrics from two collections:

- **Standard and Natural Textures Collection:** Solid and patterned light filtering and room darkening colors.

Operating Cords

- The cord loop is made of white nylon.
- Standard cord placement is right. Please specify location when ordering.
- Cord Loop System cords come in 2 foot to 15 foot lengths in 1 foot intervals. Please specify length when ordering.

Standard loop sizes are as follows:

Blind Length	Standard Loop
Up to 36"	2' (24")
36" to 60"	3' (36")
60" to 84"	4' (48")
84" to 108"	5' (60")
108" to 120"	6' (72")

Vane Stack

Odysee Blinds are designed for both function and aesthetics with the opening and closing of the vanes, providing a view-through to the outside. While an Odysee Blind can be raised and lowered, a raised blind may result in a wavy stack resulting from the accumulation of aluminum lifters located on the cords. The aluminum lifters allow the vanes to be opened and closed



Odysee Vane Characteristics

What size is a vane?

A vane is 1" high.

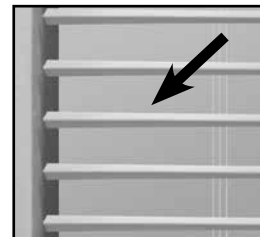

Vane Flare

A certain level of flare is common on the sides of the vane. This characteristic is designed into the blind to assist in closure when the vanes are fully expanded.

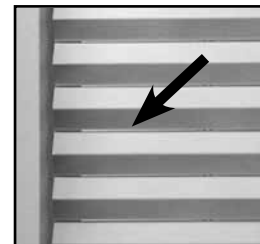

Vane Gap

It is not uncommon to have very small gaps between the vanes; however, the gaps should not be large enough for you to "view through" to the outside.

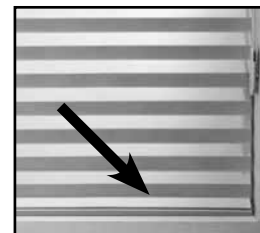

Bottom Vane

The bottom vane is designed to stay flat and may appear extra. In addition, some blinds may need an extra vane in order for the blind to reach the bottom sill. When the vanes are expanded, the extra vane may be partially compressed because of the size of the window.

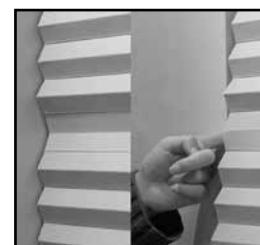

What do I do if an expanded vane is pushed in?

If the vane is pushed in, do not raise the blind. Carefully push the vane out with your finger or the eraser end of a pencil.

What do I do if the vanes do not expand or compress uniformly?

If one or more vanes hang up when opening or closing the blind, you can reset the vanes by toggling the cord loop back and forth.

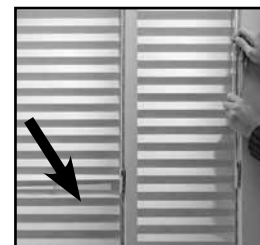

Are there color differences between Light Filtering and Room Darkening Vanes?

Due to the differences between the light filtering and room darkening base material, slight color variations may exist. These slight color variations are within established industry standards and should be expected.

Odysee Cellular Blinds

Stack Height

All measurements include head and bottom rails.

Blind Length	Stacking Height
Up to 12"	3¼"
12½" to 24"	4¼"
24½" to 36"	5¼"
36½" to 48"	6¼"
48½" to 60"	7¼"
60½" to 72"	8¼"
72½" to 84"	9¼"
84½" to 96"	10¼"
96½" to 108"	11¼"
108½" to 120"	12¼"

Odysee Cellular Blinds

CORDLESS POWERTOUCH

Cordless PowerTouch Push Button Control

Odysee Cellular Blinds can be fabricated with the Cordless PowerTouch Push Button Control option.

The PowerTouch option is an easy, cord free motorized operation for the budget savvy homeowner. PowerTouch uses Simplicity motors and components.

PowerTouch Operation

Press and hold the up or down button on the pendant to adjust the blind position. Release the button to stop the blind at your desired position. No programming is required.

The PowerTouch system is most convenient for adjusting the vanes between open and closed; but can also be used to raise and lower the blind.

All fabrics will use white wand and pendants.
All standard Odysee discounts apply to PowerTouch Blinds.

PowerTouch Appearance

- The PowerTouch wand and pendant is attached to the head rail and requires no additional mounting.
- The wand and pendant hangs down the front of the blinds from the head rail. The wand does not touch the fabric.
- Pendant is 2½" long.
- The pendant does not need to be mounted to the wall to operate the blind.

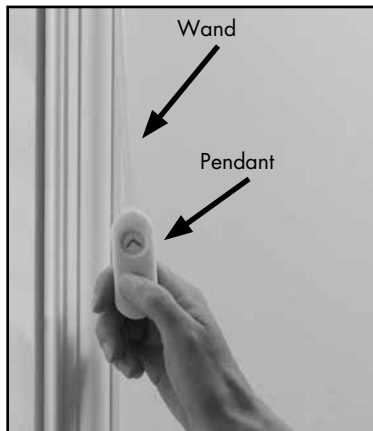

PowerTouch Color Options

- All Odysee Blinds will use white wand and pendants.

PowerTouch Wand Length

- The standard length of the wand will measure half the ordered length of the blind.
- Maximum wand length is 56" including the pendant.
- Custom wand lengths are available in 1" increments up to 56", specify when ordering. Custom wand length surcharge of \$31.00 applies.

PowerTouch Wand and Pendant Location

The standard location for the wand and pendant is on the right. Please specify location when ordering.

Mounting Requirements for Odysee Cordless PowerTouch Blinds

- No special installation hardware or wiring requirements are needed to install Odysee Cordless PowerTouch Blinds.
- The wand and pendant do not need to be mounted to operate the blind.

Cordless PowerTouch Blinds Battery Wand

The battery wand is wall or ceiling mounted utilizing white battery wand clips. The 12 volt battery wand measures 17¼", and comes with eight alkaline batteries, and is white in color.

The battery wire is 10" long. A 48" extension wire is available.



PowerTouch Wand Battery Life and Replacement

Eight alkaline batteries are included with the battery wand. The battery life will vary based on the type of window covering selected, the size and weight of the window covering and the number of times you operate the blind on a daily basis.

Comfortex will warranty batteries for up to 3 months from date of purchase.

DC Power Supply/Transformer

12 Volt DC power supply/transformer is available and requires a standard power outlet to power the motor. The transformer is an alternative to a battery wand. Each transformer can power a single blind. The power supply must plug in to the motor. The DC power supply is white and comes with a 80" wire. The dimensions are 1⅞" wide x 3¼" long x 1¼" deep.

Odysee Cordless PowerTouch Blinds Warranty

Please see page 138 for complete warranty information.

Odysee Cellular Blinds

SIMPLICITY MOTORIZED ODYSSEE CELLULAR BLINDS

Motorized Odysee Cellular Blinds

Odysee Cellular Blinds can be motorized with Simplicity Radio Controlled Motors.

Simplicity Motor Program

The Simplicity Motor program features a battery powered motor utilizing a single 12 volt battery wand or DC (Plug-in) transformer. Simplicity motors are compact and use a radio controlled remote to raise or lower the blinds.

Mounting Requirements For Motorized Odysee Cellular Blinds

No special installation hardware or wiring requirements are needed to install motorized Odysee Blinds. See page 127 for mounting information.

Simplicity Battery Wand

Batteries are needed to operate Simplicity motors. The battery wand is can be clipped to the head rail or wall or ceiling mounted utilizing white battery wand clips. The 12 volt battery wand measures 17¼", and comes with eight AA alkaline batteries, and is white in color.

The battery wire is 10" long. A 48" extension wire is available.



Simplicity Motor Battery Life and Replacement

Eight alkaline batteries are included with the wand. The battery life will vary based on the type of window covering selected, the size and weight of the window covering and the number of times you operate the shade on a daily basis. For example, a 36" x 60" single honeycomb shade operated twice daily will have a battery life which lasts up to 18 months.

Comfortex will warranty batteries for up to 3 months from date of purchase. Batteries are not covered by the warranty.

Simplicity Motor Hand Held Remotes

5 Channel Remote

The **5 Channel (5C) remote** can operate up to five shades simultaneously, individually or in groups. **WHEN ORDERING PLEASE SPECIFY WHICH CHANNELS ARE ASSIGNED TO EACH SHADING OR GROUP OF Shades.**

For example; program line 1 to channel 1, line 2 and 3 to channel 2, etc. If no channels are assigned at time of order, all shades will be programmed to Channel 1.



Simplicity 5C remotes and holders are white or black in color. The remote comes with a holder which can be mounted to a wall for easy storage. The range of the remote is approximately 80 feet.

6 Channel Timer Remote

The **6 Channel (6C) timer remote** combines the functionality of a fifteen channel hand-held control with the convenience of a programmable timer.

- The 6C timer remote allows for 18 different scheduled actions each day of the week.
- Manual function disables the timer and the remote then operates as a 1-channel hand held remote.



WHEN ORDERING PLEASE SPECIFY WHICH CHANNELS ARE ASSIGNED TO EACH SHADING OR GROUP OF SHADES.

For example; program line 1 to channel 1, line 2 and 3 to channel 2, etc. If no channels are assigned at time of order, all shades will be programmed to Channel 1.

Simplicity remotes and holders come in white. The remote comes with a holder which can be mounted to a wall for easy storage. The range of the remote is approximately 80 feet.

DC Power Supply/Transformer

12 Volt DC power supply/transformer is available and requires a standard power outlet to power the motor. The transformer is an alternative to a battery wand. Each transformer can power a single shading. The power supply must plug in to the motor. The DC power supply is white and comes with a 80" wire. The dimensions are 1⅞" wide x 3¼" long x 1¼" deep



Odysee Cellular Blinds

Odysee Cellular Blind

RECHARGEABLE SIMPLICITY MOTORIZED BLINDS

Rechargeable Simplicity Motors

The Simplicity Motor program features a battery powered motor utilizing a rechargeable battery wand. Simplicity motors are compact and use a radio controlled remote to raise or lower the shades.

Rechargeable Motorized Lift Systems are not offered on sizes within the shaded area on the Standard Rectangular price grids.

Applications

- Standard Rectangular

Simplicity Rechargeable Battery Wand

The wand will be concealed in the head rail on shades over 28" wide. The battery wand measures 22", comes with NiMH rechargeable batteries, and is white in color. For blinds less than 28" wide, the rechargeable battery wand can be clipped to the wall or ceiling mounted utilizing supplied battery wand clips.

Rechargeable battery wand comes fully charged from the factory.



Rechargeable Battery Wand Concealed in Head rail.
(Minimum width of 28" required)

Simplicity Motor Hand Held Remotes

The same remotes used for Simplicity motorized blinds can be used for Rechargeable Motorized Odysee Cellular Blinds, see page 130 for more information and options.

Mounting Requirements

No special installation hardware or wiring requirements are needed. See page 127 for mounting information.

Battery Charger

14 Volt charger requires a standard power outlet to recharge the battery wand. Must specify charger when ordering a Simplicity Rechargeable Wand Shade. The charger plugs into the charger port. The charger is black and comes with a 156" wire. The dimensions are 1 7/8" wide x 3 1/4" length x 1 3/4" deep.

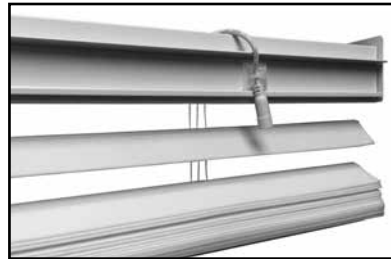

Charging Port on Back of Head rail



Simplicity Rechargeable Battery Life

Rechargeable batteries are included with the motor.

The average battery charge will last 6-12 months based on an average sized shade raised and lowered once per day. The life of a single charge will vary based on the type of window covering selected, the size and weight of the window covering and the number of times the cellular blind is operated on a daily basis.

The battery can be recharged up to 500 times. It takes approximately 5 hours to recharge the motor when fully depleted.

Retrofit Existing Standard Simplicity Motorized Shades with Rechargeable Batteries

Cellular shades made with Standard Simplicity Motorization can be retrofitted with the Rechargeable Simplicity Motorization Battery Wand. The Rechargeable battery wand is 22" long, comes with 10 NiMH batteries, and is white in color. Battery wands are charged at the factory.

To retrofit the rechargeable battery wand to an existing shade with a cassette head rail, you must have at least 24" between bracket centerlines to fit the battery wand. Otherwise, the wand must be placed elsewhere along the window. Wall mounting clips are provided with the wand.

Retrofit Ordering Requirements:

- Rechargeable battery wand with clips (one per shade)
- Rechargeable battery charger (one or more per order, or as needed)
- Charge port mounting base (optional)

Please contact customer service for more information.

Operating Odysee Blinds

- A single cord loop and clutch combination is used to raise and lower the blinds, as well as open and close the vanes.
- To compress the vanes or lower the blind, pull on the rear of the cord loop. To expand the vanes or raise the blind, pull on the front of the cord loop.

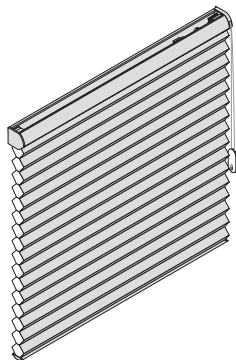

Privacy Position
(Vanes expanded)

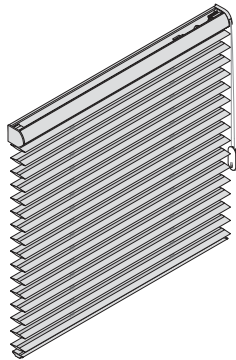

View-Through Position
(Vanes compressed)

If at any time the vanes do not expand or compress uniformly you can reset the vanes by toggling the cord loop. Opening and closing the vanes should re-align them with uniform expansion or compression.

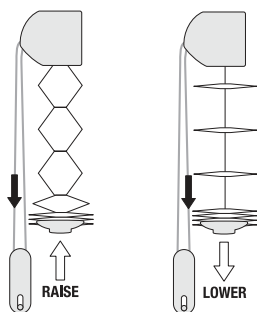

Bottom Rail

Odysee Cellular Blinds feature a creamy white bottom rail.

When the vanes are expanded (closed), the bottom rail touches the window sill. When the vanes are compressed (open), the bottom rail may lift off the sill slightly. This is normal.

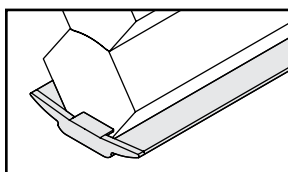

Odysee Certified Fabrics

The GREENGUARD Environmental Institute has established performance based standards to define goods with low chemical and particle emissions for use indoors.

Odysee fabrics have the earned the following certifications:

- GREENGUARD Indoor Air Quality Certified® certification for low emitting interior building materials, furnishings, and finish systems.
- GREENGUARD Children & SchoolsSM product certification for low emitting interior building materials, furnishings, and finish systems used in educational (day care and K-12) environments.

Measuring Instructions for Odysee Cellular Blinds

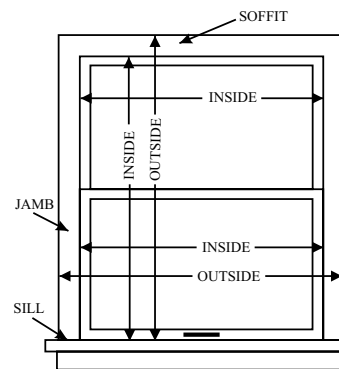

Comfortex accepts measurements down to 1/16" increments.

Inside or Side Mount

Use a steel tape to measure the opening at three different places, and use the narrowest dimension when ordering. Be exact! The factory will make the vanes narrower so they will not rub against the window casing. Measure the height of the window from the top (soffit) down to the sill.

Outside Mount

Use a steel tape to measure the exact height and width of the area to be covered. It is recommended that the blinds overlap the window by at least 1 1/2" on each side. When installation has no sill, allow the blind to overlap the bottom of the window casing by at least 1 1/2". Blind fabric will measure width indicated on the order form.

Cleaning and Care of Odysee Cellular Blinds

Regular feather dusting or vacuuming will keep Odysee Cellular Blinds looking new for years.

Odysee Cellular Blinds can be spot cleaned. Gently blot the stain with a clean, non-alcohol baby wipe. Instead of a baby wipe, you may use a clean white cloth with a mild cleaning solution. Support the fabric from behind using another clean, dry cloth. Clean the fabric using a gentle blotting action. Do not rub the fabric. Any abrasive action may cause the fabric to pill or distort. Allow the fabric to air dry with vanes expanded.

Forced air can also be used to blow out dirt and debris from within the vanes using clean compressed air or a hair dryer on the COOL setting.

Odysee Cellular Blinds can also be ultrasonically cleaned. Do not immerse the head rail. Comfortex acknowledges these cleaning methods as being safe and effective. We cannot attest to the quality of equipment or services provided by any independent cleaning facility.

Cellular Shade MEASURING INSTRUCTIONS

Comfortex accepts measurements down to $\frac{1}{16}$ " increments.

Inside Mount

Use a steel tape to measure the opening at three different places, and use the narrowest dimension when ordering. Be exact! The factory will make the shade $\frac{3}{16}$ " narrower so it will not rub against the window casing. Measure the height of the window from the top (soffit) down to the sill.

Outside or Ceiling Mount

Use a steel tape to measure the exact height and width of the area to be covered. It is recommended that the shades overlap the window by at least $1\frac{1}{2}$ " on each side. When installation has no sill, allow the shade to overlap the bottom of the window casing by at least $1\frac{1}{2}$ ". Shade fabric will measure width indicated on the order form.

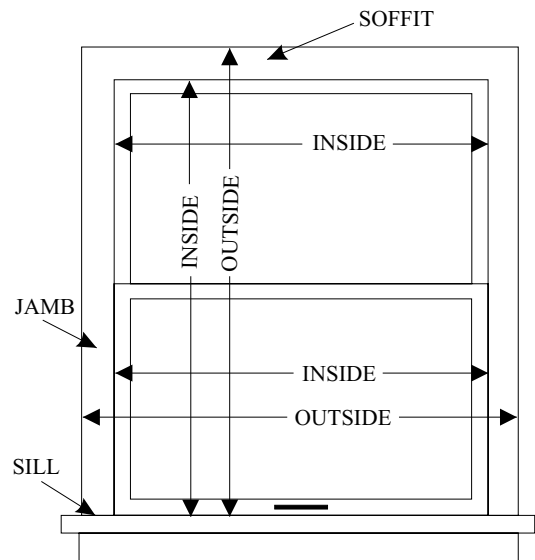

Measuring for Specialty Shapes

Templates are required with some specialty shade orders. Consult the individual product sections of this guide for specifics regarding accurate measurements and mounting information.

Arches and Quarter Round Circles

- Measure the window height and width appropriately for an inside or outside mount.
- With perfect arches, the height will be one half the width. With perfect quarter rounds, height will equal width. If the arch or quarter round is perfect, a **template is not required**.
- Windows with imperfect arch measurements do not maintain the height/width relationship. Templates **are required** for these windows.

Trapezoids

- Measure the window height and width appropriately for an inside or outside mount. For outside mounts, remember to add the desired amount of overlap.
- Either the top or bottom of the shade is sloped or angled.
- Measure all four sides for accurate fabrication. Provide all measurements. **Templates are not required**.
- The slope angle must be measured with a protractor. Slope is the angle between slope and a horizontal line. The maximum slope is 30 degrees.

Octagons

- Measure the window height and width appropriately for an inside or outside mount. Be sure to measure the width at the shade's widest point.
- Provide the width, length and the length of one side when ordering.

Making the Perfect Template

Tape brown craft paper over the window opening. Be sure to allow plenty of overlap and check to see that the paper is smooth and pulled taut. Do not use newspaper as the ink can rub off on fabric. Do not use paper that has been folded. Notice the outline of the framework superimposed on the template as the light filters through the window. You may create the template in one of two ways:

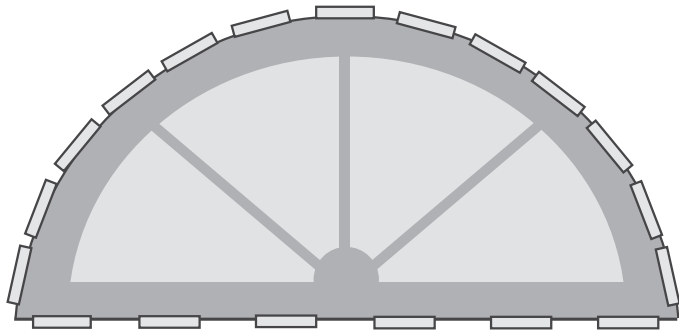

Trace the outline of the window with a pencil and continue along the side of the window frame. Once the window is completely traced, remove the craft paper from the window. Cut out the traced shape with a pair of scissors.

You may choose to skip tracing the window outline with a pencil and cut out the shape immediately with a razor knife.

With arch top shades, fold the template in half. Check the outline of the curve for smoothness, light gaps and curve continuity. Place the template in the window and check it for light gaps or uneven cutting of curve. Trim or remake it if necessary.

On the front of the template, mark the shade measurements along with your company name, account number, sidemark, shade style and color. Be sure to indicate inside or outside mount, the room side and which ends of the template are top and bottom. Do not take any deductions on inside mount shades. The factory will make all necessary allowances for inside mounts.

Remember: The quality of the finished shades depends heavily on the quality of the template supplied. Do not hesitate to remake a template if you feel uncomfortable of the quality of your first attempt.

Template Kits: Comfortex offers template kits which includes brown craft paper, razor knife, instructions and order form. Please contact Customer Service or visit www.comfortexdealers.com to order. Stock number: 751000

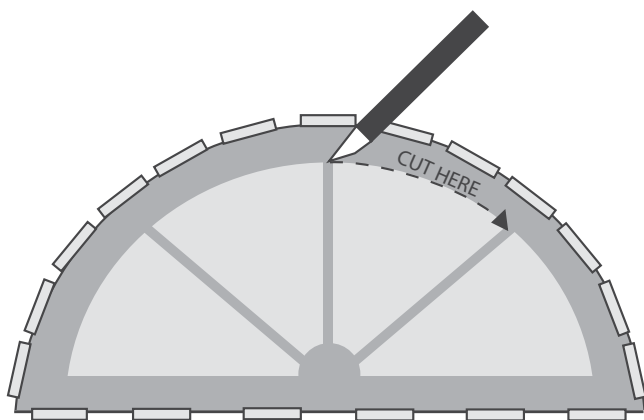

Once your template is cut, double check its width and height with your initial measurements. Test the template by placing it in the window. Check for light gaps, uneven cutting of curves etc. Trim or remake if necessary.

Child Safety

Comfortex has a long history of designing new child-safety products and is proud to provide a leadership role in cooperating with the Consumer Product Safety Commission (CPSC) for the development of policies and guidelines for the industry by serving on the WCMA Standards Development Committee.

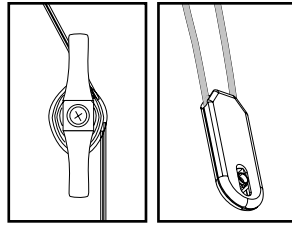

Cord Cleat

Cord Tensioner

All Comfortex products have been fully tested and proven to comply with the current WCMA Standards for safety of corded window coverings.

Be aware that it is possible for children to become entangled in window covering cords. To reduce the risk of accidents, all cords must be kept out of the reach of children. A cord cleat or cord tensioner is an effective way to implement this essential precaution. Please use them.

To mount the cord cleat at a safe height, take into account furniture or other objects upon which a child may climb. Then, after the use of the blind, simply wrap the excess cord around the cleat.

Conditions of Sale

All Comfortex products are custom fabricated to your exact specifications. We cannot accept responsibility for errors in ordering or cancellations and charges after the order is in production.

Policies

Our policies are designed to provide a guide for doing business with Comfortex. Our first priority and number one policy is to provide the highest level of service and total satisfaction.

Freight

Comfortex will ship all orders for fabricated shades or blinds freight free via UPS, FedEx Ground or other similar method within the continental United States*.

A \$3.75 per unit transportation surcharge will be added to all fabricated product orders, within the continental United States, including shades/blinds, vane packs, individual vanes, tracks, valance and cut yardage orders.

In addition, a \$70.00 Common Carrier surcharge** will be added for all orders shipped within the continental United States*, that include shades, blinds or valances with widths of 98" or more and are required to ship by motor freight. Exception: Verticals with lengths of 84" or more, and Roman Shades with widths of 94" or more are required to ship by motor freight.

***Hawaii:** Shipments to Hawaii will incur a freight charge of \$50.00 per unit when shipped from within the Continental US.

****In Addition,** a \$110.00 Common Carrier surcharge for

! WARNING	
	The cords on this product present a potential strangulation hazard.
	For child safety, consider cordless alternatives or products with inaccessible cords.
! ADVERTENCIA	
	Los cordones de este producto representan un peligro potencial de estrangulamiento.
	Para la seguridad de los niños, utilice alternativas sin cordón o productos cuyos cordones sean inaccesibles.
! MISE EN GARDE	
	Les câbles de ce produit représentent un danger potentiel de strangulation.
	Pour la sécurité des enfants, pensez au sans fil, ou procurez-vous des produits dont les câbles ne sont pas accessibles.

oversized shipments will be added to orders shipping to Hawaii.

***Alaska:** Shipments to Alaska will incur an \$8.00 per unit transportation surcharge when shipped from within the Continental US.

****In addition,** a \$110 Common Carrier surcharge for oversized shipments will be added to orders shipping to Alaska from within the Continental US.

Canada: Shipments to Canadian Dealers will incur a \$6.00 per unit transportation surcharge when shipped from within the Continental US. In addition, a \$110 Common Carrier surcharge for oversized shipments will be added to orders shipping to Canada from within the Continental US.

Policies and Warranty

Freight continued

Comfortex Mexico Plant: All shipments from our Mexico plant to Alaska, Hawaii or anywhere outside the Continental US will incur all freight charges (freight forwarder needed if shipping to another country).

All Other Countries: All United States dealers requesting to ship orders outside the United States must provide a freight forwarder for Comfortex to ship to within the continental United States. Comfortex cannot ship directly to your customers located outside the United States.

Please Note: Comfortex reserves the right to select another carrier, modify shipping terms or change freight policies without notice.

Service and Repair

Service may be obtained by contacting our Customer Service Department. No products, parts, components or other materials will be authorized for return or repair without prior approval from Comfortex. A Return Authorization (RA) may be obtained by contacting our Technical Service Department. In order to provide the quickest service possible, please have your Comfortex Work Order number and original order information available when you call.

Specifications

All Comfortex products are designed and tested to perform as intended within established, published parameters. Requests for "custom fabrication" of products outside of our published specifications may be considered, but are at the discretion of the Comfortex Technical Services department. Restrictions and additional charges apply.

Download installation instructions, order forms or additional price list copies on the Comfortex OnDemand Library or www.comfortexdealers.com in the Dealers Resource Center.

Odysee Fabric Color Variations

Due to the differences between the light filtering and room darkening base material, slight color variations may exist. These slight color variations are within established industry standards and should be expected.

Custom Graphics Cellular Shades Color

Warranty

Comfortex utilizes state of the art technology to provide you Custom Graphics Shades within 2 Delta-E (DE) of the sample fabrics found in the Comfortex Collections Cellular and Pleated Sample Book. When viewed under different lighting sources such as fluorescent, incandescent, halogen, ultraviolet and others, fabrics may appear different to the eye. Comfortex utilizes the worldwide lighting standards of Daylight 65 (D65) as our official standard for measuring and qualifying color accuracy, because D65 daylight bulbs best represent actual "daylight" illumination. Slight color variations (under 2 DE) are within established industry standard and should be expected.

This warranty is in addition to Comfortex limited lifetime warranty.

Scotchgard™ Warranty

Comfortex Window Fashions provides a limited warranty for fabrics treated with Scotchgard™ Protector against permanent stains for a period of 1 year from the date of original purchase.

This warranty excludes conditions or damages resulting from accidents, alterations, exposure to the elements, and exposure to any and all natural and manufactured excessive heat sources, or failure to follow the Installation and Care instructions. This warranty also excludes fabric submerged in water or cleaning solutions, or treated with household products that may alter or deplete the effectiveness of the treated fabric. In addition, the following types of stains are excluded from this limited warranty: pet stains, bodily fluids, stains caused by wine, bleach, plant fertilizers, acne medication, misuse or abuse. This warranty is not a cleaning contract and does not cover the cleaning of fabrics that are soiled or discolored through daily use. This warranty coverage is limited to residential use and is not transferable.

The following are the recommended cleaning and care instructions for window treatments with fabric treated with Scotchgard™ Protector.

- Gently blot liquid stains immediately with a clean, white cloth.
- If stain remains, prepare a solution of ¼ teaspoon of clear, non-bleaching dish detergent mixed with 1 cup of lukewarm water. Dampen a clean white cloth and gently blot the stain.
- Do not overwet the fabric or excessively rub the stained area.
- See the Installation and Care instructions for complete details.

For additional assistance with stain removal, call the Scotchgard™ Protector Service Center at 1-800-433-3296. Customer Care representatives are available Monday through Friday, 8am to 6pm CT.

Should the results of the cleaning and care instructions not result in the removal of permanent stains covered by this limited warranty, Comfortex will retreat or replace the fabric, at its discretion, for a period of 1 year from the date of original purchase. Customer must provide proof of purchase and provide proof the stain occurred during the warranty period. Shipping and handling costs to send the window treatment back to Comfortex are the responsibility of the customer.

This warranty gives you specific legal rights, and you may also have other rights which vary from state to state.

Cellular, Pleated and Prelude Shades

Odysee Cellular Blinds Warranty Information

Comfortex warrants that its window treatments will be free from defects in materials and workmanship for as long as the original residential purchaser owns the product, provided that the product was installed properly and in accordance with the installation instructions. The limited lifetime warranty is extended to the original residential purchaser only, in the original window for which it was installed.

The warranty does not include any conditions or damages resulting from accidents, alterations, misuse, abuse, misapplication, improper handling, installation, repairs, operation, cleaning, exposure to any and all natural and manufactured excessive heat sources. (Excessive heat sources include, but not limited to; magnification of sun light through cubes of glass, heaters of any kind, ovens, candles, lighting fixtures, etc.) This warranty does not cover variation in fabric color, grain, or texture. Loss of pleating is not covered if the product is not being cycled (held in the raised position a portion of the time). Normal wear and tear is not covered.

All moving parts, such as cords, will eventually wear out and fabric may fray. Comfortex considers these things as normal wear and tear which will carry a three year limited warranty. All fabric, including fabric vanes, panels, inserts, and shades carry a five year warranty.

This limited warranty does not cover transportation costs to and from the retailer, costs of removal, re-measure, reinstallation of product, or any incidental or consequential damages.

If a Comfortex product is found to be defective in materials or workmanship, we will, at our discretion, repair, replace or refund the cost of a product which fails to conform to this limited warranty. Colors vary from lot to lot and may not exactly match sample swatch, sample book, or previous purchases. Discontinued components or color selections will be replaced with the closest equivalent current product. This shall be your sole remedy under this limited warranty.

To obtain service, the end user should contact the dealer from whom they purchased the product.

This warranty is exclusive and in lieu of all other obligations, liabilities or warranties. In no event shall Comfortex or its licensed fabricators or distributors be liable for incidental or consequential damages, or for any other damage, loss or expense, cost or fee associated with such damage. In some states, exclusions for incidental or consequential damages are not allowable.

This warranty gives specific legal rights, and customers may also have other rights, which vary from state to state. Policy is subject to change without notice.

This limited warranty is exclusive of commercial use. Contact Comfortex Technical Service for more information. No agent, representative, dealer or unauthorized employee has the authority to increase or alter the obligation of this warranty.

This limited warranty supersedes any previous versions.

Motorized Cellular and Pleated Shades and Odysee Cellular Blinds Warranty

Simplicity Motors including PowerTouch and Rechargeable Simplicity Motorization

We offer a 5 year warranty on all motors and controls. Specifically, we warrant the Simplicity motors and controls to be free from defects in material and workmanship under normal and proper use for a period of 5 years commencing with the date stamped on each product. If the Simplicity product fails within this 5 year period, we will repair or replace it free of charge through end user product supplier. Comfortex will warranty non-rechargeable alkaline batteries for up to 3 months from date of purchase. Simplicity Rechargeable (NiMH and Li-Ion batteries) are covered by a 5 year warranty.

©2017 COMFORTEX CORPORATION

™ is a trademark of Comfortex Corporation. ® is a registered trademark of Comfortex Corporation. The GREENGUARD INDOOR AIR QUALITY CERTIFIED Mark is a registered certification mark used under license through the GREENGUARD Environmental Institute. GREENGUARD Children & SchoolsSM is a service mark used under license through the GREENGUARD Environmental Institute. Energizer® is a registered trademark of Energizer Holdings, Inc. Symphony®, Virtuoso®, and Soprano® are registered trademarks of Comfortex Corporation. Symphony® is covered by U.S. Patent Nos. 5,193,601 and 4,974,656 respectively. Virtuoso® Light Filtering Fabric is covered by U.S. Patent No. 4,631,217. Baritone™ is covered by U.S. Patent Nos. 4,450,027, 5,482,750, 5,601,885 and 4,631,217. Ovation™ Cellular Slider is covered by one or more of the following U.S. Patent Nos.: 4,862,941, 4,858,668, 4,915,153, D346,032, D324,108, 4,450,027, 4,631,108, 4,603,072, 5,690,778, 5,664,773, 6,319,586, 5,482,750, 5,601,885 and 4,631,217. SlumberShade™ is covered by U.S. Patent No. 8,371,355. Karma-Light™, PowerTouch™, Timeless Textures™, Debut™, Privada™, Cordless Ultra™, Sunset™, Baritone™, Balcony™ and Ovation™ are trademarks of Comfortex Corporation. Other U.S. and foreign patents pending. All rights reserved.

Odysee is covered by U.S. Patent Nos. 5918655, 4372432, 4433765, 4623012, 5697630, 5058720, 5228491, 5375643, 5733632 and 5680891. Additional U. S. and foreign patents pending.



Odysee™ Cellular Blinds

What's Inside:

- **2 NEW Fabrics:** Verona and Boutique Light Filtering and Room Darkening
- **NEW** PowerTouch™ Rechargeable for Cellular Shades
- Simplicity Rechargeable Motorized Shades and Blinds
- Optional Scotchgard™ Stain Protection for Cellular Shades
- Prelude Cellular Shades
- Privada™ Privacy Pleated Shades
- Odysee™ Cellular Blinds
- Custom Graphic Shades
- Certified Best For Kids Products



www.midwestdesignersupply.com



511005PL 05/17

Scotchgard™ is a trademark of 3M.

888-523-2611
262-524-1007 (fax)