

COLOR LUX™

— Designer Cellular & Roller Shades —

800 COLORS AVAILABLE



2017

Manufacturer's Price List and Reference Guide | Effective May 1st



Midwest
Designer
Supply

www.midwestdesignersupply.com

888-523-2611
262-524-1007 (fax)



Comfortex
WINDOW FASHIONS

Comfortex Color Lux® Cellular, Roller and Panel Track Shades

Price List and Reference Guide

Effective May 1, 2017 - Updated August 1, 2017

This price list and reference guide contains product pricing, product specifications and technical information for the complete line of Comfortex Color Lux Cellular, Roller and Panel Track Shades.

Color Lux Cellular Shades

Hardware Options	1-2
Hardware Upgrades and Surcharges.	3
Size Standards	4-6
Shade Stack Heights	7
Price Group 1: Standard Rectangular - Color Lux Linen Weave ¾" Light Filtering.	8
Price Group 2: Standard Rectangular - Color Lux Linen Weave ¾" Room Darkening	9
Price Group 3 & 4: Ovation™ Cellular Sliders - Color Lux Linen Weave ¾" Light Filtering and Color Lux Linen Weave ¾" Room Darkening	10
Price Group 5 & 6: Starburst Non-Movable & Movable Arches - Non-Movable & Movable Quarter Rounds Color Lux Linen Weave ¾" Light Filtering and Color Lux Linen Weave ¾" Room Darkening	11
Price Group 7 & 8: Sunset™ Movable Arches - Color Lux Linen Weave ¾" Light Filtering and Color Lux Linen Weave ¾" Room Darkening.	12
Price Group 9 & 10: Trapezoids and Octagons - Color Lux Linen Weave ¾" Light Filtering and Color Lux Linen Weave ¾" Room Darkening.	13
Price Group 11 & 12: Mezzo Motorized Skylights - Color Lux Linen Weave ¾" Light Filtering and Color Lux Linen Weave ¾" Room Darkening.	14
Price Group 13 & 14: Non-Movable Door Decor - Color Lux Linen Weave ¾" Light Filtering and Color Lux Linen Weave ¾" Room Darkening.	15
Price Group 15 & 16: Movable Door Decor - Color Lux Linen Weave ¾" Light Filtering and Color Lux Linen Weave ¾" Room Darkening.	16
Hardware - Standard Cord Lock Shades	17-18
Hardware - Cord Loop Hardware System.	19-20
Hardware - Cordless Ultra™ Hardware System.	21-22
Hardware - Cordless Lift & Lock Hardware System.	23-24
Hardware - Ovation Cellular Sliders	25-26
Hardware - Motorized Shades (including NEW Rechargeable Battery Motorization)	27-31
Hardware - Simplicity Smart Controller	32
Hardware - PowerTouch Rechargeable Motorized Shades	33-34
Hardware - NEW Simplicity Wave Rechargeable Motorized Shades	35-36
Hardware - Insulating SlumberShades	37-38
Hardware - Starburst Arches.	39
Hardware - Quarter Rounds	40-41
Hardware - Sunset Arches	42-43
Hardware - Trapezoids and Octagons.	44-45
Hardware - Mezzo Motorized Skylight Shades	46-48
Hardware - Door Decor	49-50
Hardware - Day-Night Shades	51-52

Color Lux Roller Shades

Key Features for Roller Hardware Options	55-57
NEW Skyline Hardware Roller Shades	57-58
Skyline Surcharges	59-60

Price Group 17: Standard Rectangular - Color Lux Classic Duck Light Filtering	61
Price Group 18: Standard Rectangular - Color Lux Classic Duck Blackout	62
Price Group 19: Standard Rectangular - Color Lux Linen Light Filtering	63
Price Group 20: Standard Rectangular - Color Lux Linen Blackout	64
Price Group 21: Standard Rectangular - Color Lux Solar Screen 5	65
Color Lux Fabric Information and Fire Rating	66
Hardware Details - Standard Roller	67
Hardware Details - Skyline Standard Roller.	68
Hardware Details - Cordless Roller with Deco-Bar	69
Hardware - Designer Cassette with Insert Strip	70
Hardware - Designer Cassette with Fabric Wrap.	72
Hardware - Designer Cassette with Smooth Face.	72
Hardware - Three Inch Fascia	73
Hardware - Four Inch Fascia	74
Hardware - Four Inch Skyline Fascia	75
Hardware - Dual Roller with Skyline Hardware	76
Highlights Cornice Valance with Keystone	77-79
Dual Roller Shades with Skyline Hardware	80
Two-on-One Head Rail	81
Two-on-One No Head Rail and Side by Side Mounting with Skyline Hardware.	81
Cordless Operation Options	82
Tassels and Pulls	83
Cord Loop Operation Options	84
Skyline Hardware Tensioner Information	84
General Information	85
Power Touch Rechargeable	86-87
Simplicity Motorization (Including Simplicity Rechargeable Motorization)	88-89
Simplicity Rechargeable Motorization	90-91
Simplicity 6 Channel Timer Remote Information.	91

Color Lux Panel Track System Shades

Features and Benefits of the NEW Panel Track System	93
Stacking Options	93
Panel Attachment Method	93
Head Rail Colors	93
Bottom Rail Style	93
Fabric Panel Information	93
Panel Custom Overlaps.	93
Control Options	94
Panel Widths.	94
Head Rail Splicing	94
Track Specifications	94
Grid #22 & 23: Includes Classic Duck Light Filtering, Classic Duck Blackout, Linen Light Filtering,	
Linen Blackout, and Solar Screen 5	95
Finished Dimensions	96
Mounting Options	96
Panel Stack Back	96

Light Gap	96
Fabric Deductions and Specifications	96
Outside Mount Hardware Profiles.	97
Inside Mount Hardware Profiles	98

Color Lux Custom Graphics - Effective July 1, 2017

General Information and How to Order	99-101
Pricing	102-103

Color Lux General Information

Cut-Outs, Scotchgard™ Protection and Certified Fabrics	105
Highlights Cornice Valances.	105
Stack Heights	105
Child Safety	106
Cleaning and Care	106
Measuring Instructions	107
Making Template	107
Conditions of Sale.	108
Policies	108
Motorized Color Lux Cellular Shades Warranty	108
Scotchgard™ Warranty.	109
Color Lux Warranty Information	109-110

Color Lux® Cellular Shades



COLOR LUX
Designer Cellular & Roller Shades



Scotchgard™ Protection

Optional Scotchgard™ Protector is available with Color Lux Linen Shades. Scotchgard™ keeps your shades looking newer, fresher and cleaner longer.

A combination of the latest advances in stain release and repellency provides exceptional stain protection. Spills wipe away easily and most dirt and stains lift out when cleaned.

Color Lux® Cellular Shade Hardware Options

COLOR LUX® CELLULAR SHADES

COLOR LUX® CELLULAR SHADES

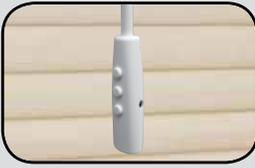
	Key Features	Hardware Options	Hardware Size (Depth x Height)	Shade Size Available*	More Information
Standard Cord Lock 	<ul style="list-style-type: none"> • Proven cord lock • Sleek, fabric wrapped rails • UV resistant cords 	<ul style="list-style-type: none"> • Fabric Wrapped • Brushed Nickel • Oil Rubbed Bronze 	2 ³ / ₈ " x 1/2"	Width: 8" to 108" Length: 8" to 120"	Page 17
Cord Loop 	<ul style="list-style-type: none"> • Cord Loop makes operation easy • Smooth & quiet operation 	<ul style="list-style-type: none"> • Fabric Wrapped • Brushed Nickel • Oil Rubbed Bronze 	2 ¹ / ₄ " x 1 ¹ / ₂ "	Width: 14" to 108" Length: 8" to 120"	Page 19
Cordless Ultra 	<ul style="list-style-type: none"> • Child safe • No visible cords • Smooth & quiet operation 	<ul style="list-style-type: none"> • Fabric Wrapped • Brushed Nickel • Oil Rubbed Bronze 	2 ¹ / ₄ " x 1 ¹ / ₂ "	Width: 18" to 96" Length: 8" to 84"	Page 21
Cordless Lift & Lock 	<ul style="list-style-type: none"> • Child safe • Easy push button operation • Rails lock securely in place in any position 	<ul style="list-style-type: none"> • Fabric Wrapped • Oil Rubbed Bronze 	2 ³ / ₈ " x 1/2" Bottom Rail: 1 ⁷ / ₈ " x 1 ¹ / ₈ "	Width: 16" to 96" Length: 8" to 84"	Page 23
Simplicity Motorization 	<ul style="list-style-type: none"> • Raise & lower shade with click of a button • Great for large and hard to reach windows • Remote can operate multiple shades 	<ul style="list-style-type: none"> • Fabric Wrapped • Oil Rubbed Bronze 	2 ¹ / ₄ " x 1 ¹ / ₂ "	Width: 18" to 96" Length: 8" to 120"	Page 27
Rechargeable Simplicity Motorization 	<ul style="list-style-type: none"> • Features a battery powered motor utilizing a rechargeable battery pack • Raise & lower shade with click of a button • Great for large and hard to reach windows • Remote can operate multiple shades 	<ul style="list-style-type: none"> • Fabric Wrapped • Oil Rubbed Bronze 	2 ¹ / ₄ " x 1 ¹ / ₂ "	Width: 18" to 96" Length: 8" to 120"	Page 29
PowerTouch Rechargeable 	<ul style="list-style-type: none"> • Raise & lower shade with push of a button • Eliminate the need to stand by the shade to operate; just touch and go • Favorite position button • Rechargeable battery wand with recharge port on pendant 	<ul style="list-style-type: none"> • Wand and pendant available in white or black 	2 ¹ / ₄ " x 1 ¹ / ₂ "	Width: 18" to 96" Length: 8" to 120"	Page 33

* Maximum widths and lengths listed do not take into account square foot or weight limitations. Make sure to refer to shaded areas on price groups for maximum size availability by fabric style.

Color Lux® Cellular Shade Hardware Options

COLOR LUX® CELLULAR SHADES

	Key Features	Color Options	Hardware Size (Depth x Height)	Shade Size Available*	More Information
Simplicity Wave Rechargeable Motorization 	<ul style="list-style-type: none"> • Features a battery powered motor utilizing a rechargeable battery • Raise & lower shade with the wave of a wand • Great for out of reach windows • Exact match soft fabric wrapped rails 	<ul style="list-style-type: none"> • Fabric Wrapped 	2¼" x 1½"	Width: 17⅝" to 96" Length: 12" to 120"	Page 35
Ovation™ Slider 	<ul style="list-style-type: none"> • Vertically oriented fabric glides across window • Shade can stack left, right or center • Great for sliding glass doors or room dividers 	<ul style="list-style-type: none"> • White (Standard) • Ivory • Beige • Tan • Gray 	3⅝" x 1¾"	Width: 12" to 120" Length: 24" to 108"	Page 25
Door Décor 	<ul style="list-style-type: none"> • Great option for narrow windows and doors • Available in movable & non-movable rails • No Pull cords 	<ul style="list-style-type: none"> • Fabric Wrapped • Brushed Nickel • Oil Rubbed Bronze 	2⅜" x ½"	Width: 3" to 36" Length: 12" to 96"	Page 49
Top Down-Bottom Up 	<ul style="list-style-type: none"> • Lower shade from top: raise from bottom • Great for privacy • Ideal for light control 	<ul style="list-style-type: none"> • Fabric Wrapped • Oil Rubbed Bronze 	2⅜" x ½"	Width: 18" to 108" Length: 8" to 120"	See Product Availability Page 17-24
Two on One Head Rail 	<ul style="list-style-type: none"> • Operate two shades on one rail • Great for larger windows • Individually operating shades 	<ul style="list-style-type: none"> • Fabric Wrapped • Oil Rubbed Bronze 	Dependent on Hardware Chosen See Above	Width: 18" to 144" Length: 8" to 120"	See Product Availability Page 17-20
Highlights Cornice Valance 	<ul style="list-style-type: none"> • Adds height to windows and hides hardware • Available as inside and outside mount • Easy to install 	<ul style="list-style-type: none"> • All Color Lux Roller Fabrics • All Envision Roller Fabrics 	Width: 4" to 216" Height: 6" Returns: 1½" to 6"	Varies by selected fabric Width: 12" to 94"	Page 53
Insulating SlumberShade™ 	<ul style="list-style-type: none"> • Ultimate blackout shade • Tracks keep out light, cold or heat • Perfect for nurseries, day sleepers 	<ul style="list-style-type: none"> • Fabric Wrapped • Brushed Nickel • Oil Rubbed Bronze • Sidetracks are available in white, tan or black 	Dependant on hardware choice	Width: 9" to 96" Length: 8" to 120"	Page 37

* Maximum widths and lengths listed do not take into account square foot or weight limitations. Make sure to refer to shaded areas on price groups for maximum size availability by fabric style.

Cellular Shade **Non-Motorized** Hardware Upgrade Options

LIFT SYSTEM	UPGRADES	ADD
Cord Lock	Top Down-Bottom Up	\$64
Cordless Lift & Lock Surcharge	Bottom Up	No Extra Charge
	Top Down-Bottom Up	\$83
Cordless Ultra	Bottom Up	\$83
	Top Down-Bottom Up	\$166
Cord Loop	Bottom Up	\$83
	Top Down-Bottom Up	\$166

DESIGNER UPGRADE OPTIONS	UPGRADES	ADD
Add to Any Lift System Upgrade (Chart to the left)	Metallic Hardware	No Extra Charge
	Fabric Wrapped Hardware	No Extra Charge
	Scotchgard Stain Protection	\$35
	Highlights Valance See Page 53 For More Information	
Light Blocking Sidetrack System	Insulating SlumberShades See Page 37 For More Information	\$134

ADDITIONAL OPTIONS	UPGRADES	ADD
Add to Any Upgrade Above	Two-On-One Head Rail	\$50 Add to Cord Lock or Cord Loop Head Rail under 108" widths
	Cut Outs	\$52 Per side
	Day-Night	Price each panel as separate shade and add together
	Ovation Center Stack	\$84
Accessories	6 Foot Expandable Pole	\$37
	12 Foot Expandable Pole	\$46

Cellular Shade **Motorized** Hardware Upgrade Options

MOTORIZED	UPGRADES	ADD	
PowerTouch Rechargeable Motorization System	Rechargeable Wand and Batteries	\$110	For More Information Page 33
	Plug-In Charger for Rechargeable Li-Ion	\$27	
Simplicity Motorization System	Motor and Battery Wand	\$334	For More Information Page 27
	Simplicity 5 Channel Remote	\$40	
	Simplicity 6 Channel Remote	\$65	
	48" Extension Wire	\$18	
	DC Power Supply/Transformer	\$63	
	Solar Panel Recharge Kit : Includes Solar Panel with brackets, rechargeable battery wand with clips and Y cable	\$173	
Simplicity Rechargeable Motorization System	Motor and Battery Wand	\$334	For More Information Page 29
	Simplicity 5 Channel Remote	\$40	
	Simplicity 6 Channel Remote	\$65	
	Plug-In Charger for Rechargeable Li-Ion	\$27	
Simplicity Wave Rechargeable Motorization System	Motor and Rechargeable Battery Pack	\$110	For More Information Page 35
	Telescoping Wand	\$29	
	Plug-In Charger for Rechargeable Li-Ion	\$27	
Simplicity Smart Controller System	NEO Controller	\$330	For More Information Page 32
	NEO Application for Mobile Devices	FREE	

SIMPLICITY MOTORIZATION PRICING EXAMPLE:

Linen Weave Light Filtering 42" x 60" Shade:	\$350.00
Simplicity Motor Surcharge:	\$334.00
Simplicity Remote Control:	\$40.00
Total List Price:	\$724.00

SIMPLICITY RECHARGEABLE MOTORIZATION PRICING EXAMPLE:

Linen Weave Light Filtering 42" x 60" Shade:	\$350.00
Simplicity Rechargeable Surcharge:	\$334.00
Plug-In Charger for Battery (required):	\$27.00
Simplicity Remote Control:	\$40.00
Total List Price:	\$751.00

Color Lux® Cellular Shade Fabric Collections Size Standards

COLOR LUX® CELLULAR SHADES



				Cord Lock		Cord Loop		Cordless Ultra		Cordless Lift & Lock	
Minimum				Standard	TD-BU	Standard	TD-BU	Standard	TD-BU	Standard	TD-BU
COLOR LUX® FABRICS				Min. Width	8" 12"	14" 22"	15" OB 18" OB 15 3/8" IB 18 3/8" IB	16" OB 20" OB 16 3/8" IB 20 3/8" IB	8" 8"	8" 8"	8" 8"
				Min. Length	8" 8"	8" 8"	8" 8"	8" 8"	8" 8"	8" 8"	
				Cord Lock		Cord Loop		Cordless Ultra		Cordless Lift & Lock	
3/4" Linen Weave				Standard	TD-BU	Standard	TD-BU	Standard	TD-BU	Standard	TD-BU
Price Group	Page	Maximum Width & Length		108" width 120" length	96" width 96" length	108" width 120" length	108" width 120" length	108" width 84" length	96" width 84" length	96" width 84" length	96" width 84" length
Light Filtering	1	8		108" width 120" length	84" width 96" length	108" width 120" length	108" width 120" length	96" width 84" length	96" width 84" length	96" width 84" length	96" width 84" length
Room Darkening	2	9		108" width 120" length	84" width 96" length	108" width 120" length	108" width 120" length	96" width 84" length	96" width 84" length	96" width 84" length	96" width 84" length
				Cord Lock		Cord Loop		Cordless Ultra		Cordless Lift & Lock	
Stacking Heights Information On Page More Information On Page				Page 7 Page 17		Page 7 Page 19		Page 7 Page 21		Page 7 Page 23	



				Motorization		Motorization		Two-On-One Head Rail		Ovation	
Minimum				Simplicity	Simplicity Wave	PowerTouch Rechargeable	Cord Lock*	Cord Loop**	Standard		
COLOR LUX® FABRICS				Minimum Width	18" OB 18 3/8" IB	17 3/8"	18" OB 18 3/8" IB	16"	36"	12"	
				Min. Length	8" 12"	8"	8"	8"	8"	24"	
				Motorization		Motorization		Two-On-One Head Rail		Ovation	
3/4" Linen Weave				Simplicity	Simplicity Wave	PowerTouch Rechargeable	Cord Lock*	Cord Loop**	Standard		
Light Filtering		Maximum Width & Length		108" width 120" length	96" width 120" length	108" width 120" length	144" width 120" length	144" width 120" length	120" width*** 108" length		
Room Darkening		Maximum Width & Length		108" width 120" length	96" width 120" length	108" width 120" length	144" width 120" length	144" width 120" length	120" width*** 108" length		
				Motorization		Motorization		Two-On-One Head Rail		Ovation	
Stacking Heights Information On Page More Information On Page				Page 7 Page 27-36		Page 7 Page 33		Page 7 Page 17-21		Page 7 Page 25	

Maximum widths and lengths listed do not take into account square foot or weight limitations. Make sure to refer to shaded areas on price groups for maximum size availability by fabric style.

* Minimum single panel is 8", maximum single panel is 108". ** Minimum single panel is 18", maximum single panel is 108".

*** Split stack sliders are available is 240", however if the width exceeds 120", the shade will be fabricated as two separate sliders. Supplied valance will create the appearance of a single slider.

Color Lux® Cellular Shade Fabric Collections Size Standards



		SlumberShade Cord Lock		SlumberShade Cord Loop		SlumberShade Cordless	
		Bottom Up	Top Down Bottom Up	Bottom Up	Top Down Bottom Up	Bottom Up	Top Down Bottom Up
ALL FABRICS	Minimum Width	9"	13"	15"	25"	16" IB	19"
	Min. Length	8"	8"	8"	8"	8"	8"

				SlumberShade Cord Lock		SlumberShade Cord Loop		SlumberShade Cordless	
				Bottom Up	Top Down Bottom Up	Bottom Up	Top Down Bottom Up	Bottom Up	Top Down Bottom Up
Light Filtering	Price Group	Page							
Linen Weave	1	8	Maximum Width & Length Refer to shaded area in price grids for max size (sq ft) by fabric style	96" width 120" length	96" width 96" length	96" width 120" length	96" width 120" length	96" width 84" length	96" width 84" length

				SlumberShade Cord Lock		SlumberShade Cord Loop		SlumberShade Cordless	
				Bottom Up	Top Down Bottom Up	Bottom Up	Top Down Bottom Up	Bottom Up	Top Down Bottom Up
Room Darkening & Blackout	Price Group	Page							
Linen Weave	2	9	Maximum Width & Length Refer to shaded area in price grids for max size (sq ft) by fabric style	96" width 120" length	84" width 96" length	96" width 120" length	96" width 120" length	96" width 84" length	96" width 84" length

				SlumberShade Cord Lock		SlumberShade Cord Loop		SlumberShade Cordless	
				Bottom Up	Top Down Bottom Up	Bottom Up	Top Down Bottom Up	Bottom Up	Top Down Bottom Up
Stacking Heights Information On Page More Information On Page				Page 7 Page 37-38		Page 7 Page 37-38		Page 7 Page 37-38	

Please Note: For any shades under 12" width, the maximum height is 80".

Color Lux® Cellular Shade Fabric Collections Size Standards

COLOR LUX® CELLULAR SHADES

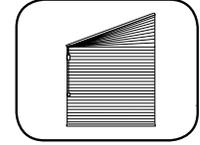
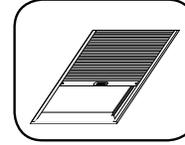
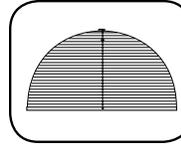
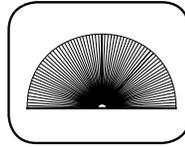

		Starburst Arch	Sunset Arch	Mezzo Skylight	Trapezoid
		Non-Movable/Movable	Movable	Motorized	Standard
COLOR LUX® FABRICS	Minimum				
	Min. Width	18"	18"	18"	12"
	Min. Length	9"	6"	12"	12"
¾" Linen Weave		Starburst Arch	Sunset Arch	Mezzo Skylight	Trapezoid
		Non-Movable/Movable	Movable	Motorized	Standard
Light Filtering	Maximum Width & Length	72" x 36"	72" x 60"	48" x 72"	48" x 72"
Room Darkening	Maximum Width & Length	72" x 36"	60" x 60"	48" x 72"	48" x 72"
		Starburst Arch	Sunset Arch	Mezzo Skylight	Trapezoid
		Non-Movable/Movable	Movable	Motorized	Standard
Stacking Heights Information On Page More Information On Page		Page 7 Page 39	Page 7 Page 42	Page 7 Page 46	Page 7 Page 44

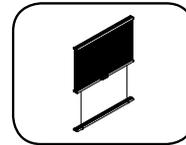
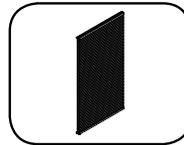
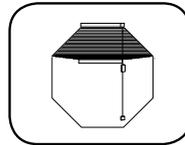

		Octagon	French Door Décor	
		Standard	Non-Movable	Movable
COLOR LUX® FABRICS	Minimum			
	Minimum Width	12"	6"	6"
	Min. Length	12"	12"	12"
¾" Linen Weave		Octagon	Door Decor	
		Standard	Non-Movable	Movable
Light Filtering	Maximum Width & Length	48" width 48" length	36" width 96" length	36" width 96" length
Room Darkening	Maximum Width & Length	48" width 48" length	36" width 96" length	36" width 96" length
		Octagon	Door Decor	
		Standard	Non-Movable	Movable
Stacking Heights Information On Page More Information On Page		Page 7 Page 44	Page 7 Page 49	Page 7 Page 49

Shade Stack Heights

Measurements are in inches. Shade stacking heights applicable when the shade is in the fully raised position.

RECTANGULAR CORD LOCK - Includes head and bottom rails	48"	72"	84"	96"
Linen Weave (All)	2"	2 ³ / ₈ "	2 ⁵ / ₈ "	2 ⁷ / ₈ "

For Top Down-Bottom Up, add ⁵/₈"

CORD LOOP - CORDLESS ULTRA - MOTORIZATION - Includes head and bottom rails	48"	72"	84"	96"
Linen Weave (All)	3"	3 ³ / ₈ "	3 ⁵ / ₈ "	3 ⁷ / ₈ "

For Top Down-Bottom Up, add ⁵/₈"

CORDLESS LIFT & LOCK - Includes head and bottom rails	48"	60"	72"	84"
Linen Weave (All)	2 ³ / ₄ "	3 ¹ / ₈ "	3 ³ / ₈ "	3 ⁵ / ₈ "

For Top Down-Bottom Up, add 1¹/₄"

OVATION	84"	96"	108"	120"
Linen Weave (All)	6 ¹ / ₂ "	7 ¹ / ₄ "	8"	8 ³ / ₄ "

Ovations minimum fabric stack measures 6¹/₂" regardless of the ordered width. Fabric stacking dimensions are determined by the slider's hardware, not ordered width.



Color Lux® Linen Weave 3/4" Light Filtering

COLOR LUX® CELLULAR SHADES

Price Group 1
Cord Lock - Fabric Wrapped or Designer Metallic Rails
Cordless Lift & Lock - Fabric Wrapped or Designer Metallic Rail

		Width In Inches														
		24	30	36	42	48	54	60	66	72	84	96	108	120	132	144
Length In Inches	36	203	226	255	282	310	335	362	386	413	472	528	583	644	700	757
	42	217	245	273	306	335	364	396	424	454	519	582	645	712	777	837
	48	229	261	295	328	362	395	427	463	496	565	635	705	779	849	918
	54	243	276	313	350	387	423	459	497	536	611	690	765	846	924	1000
	60	257	294	335	372	411	453	491	534	576	656	740	825	909	995	1081
	66	269	310	355	396	439	482	525	570	614	702	795	886	979	1067	1160
	72	282	324	372	421	466	513	561	607	653	748	849	946	1046	1142	1242
	78	295	344	392	438	493	539	590	642	693	794	902	1004	1110	1215	1317
	84	304	356	410	463	516	565	620	674	727	834	948	1055	1170	1279	1391
	90	318	371	427	482	540	596	651	708	770	883	998	1115	1233	1351	1468
	96	328	386	447	503	564	622	682	742	801	923	1047	1169	1296	1415	1540
108	356	415	482	545	616	677	743	808	877	1009	1145	1279	1418	1553	1688	
120	378	448	521	590	668	736	807	881	951	1096	1246	1393	1541	1691	1838	

Motorized Lift Systems are not offered within the shaded area.

Widths over 108" must be built as Two-On-One Shades. Surcharge is included in shades over 108" wide

LIFT SYSTEM	UPGRADES	ADD
Cord Lock	Top Down-Bottom Up	\$64
Cordless Lift & Lock Surcharge	Bottom Up	No Extra Charge
	Top Down-Bottom Up	\$83
Cordless Ultra	Bottom Up	\$83
	Top Down-Bottom Up	\$166
Cord Loop	Bottom Up	\$83
	Top Down-Bottom Up	\$166

DESIGNER UPGRADE OPTIONS	UPGRADES	ADD
Add to Any Lift System Upgrade (Chart to the left)	Metallic Hardware	No Extra Charge
	Fabric Wrapped Hardware	No Extra Charge
	Scotchgard Stain Protection	\$35
	Highlights Valance See Page 53 For More Information	

ADDITIONAL OPTIONS	UPGRADES	ADD
Add to Any Upgrade Above	Two-On-One Head Rail	\$50 Add to Cord Lock or Cord Loop Head Rail under 108" widths
	Cut Outs	\$52 Per side
	Day-Night	Price each panel as separate shade and add together
Accessories	6 Foot Expandable Pole	\$37
	12 Foot Expandable Pole	\$46

MOTORIZATION	MORE INFO
Motorized Pricing Examples - Surcharges - Options	Pg 3
Insulating SlumberShades	\$134 See Page 37 For More Information

Color Lux® Linen Weave 3/4" Room Darkening

Price Group 2

Cord Lock - Fabric Wrapped or Designer Metallic Rails
Cordless Lift & Lock - Fabric Wrapped or Designer Metallic Rail

		Width In Inches														
		24	30	36	42	48	54	60	66	72	84	96	108	120	132	144
Length In Inches	36	264	294	332	367	403	436	471	502	537	614	687	758	888	960	1035
	42	283	319	355	398	436	474	515	552	591	675	757	839	976	1061	1139
	48	298	340	384	427	471	514	556	602	645	735	826	917	1063	1154	1244
	54	316	359	407	455	504	550	597	647	697	795	897	995	1150	1252	1350
	60	335	383	436	484	535	589	639	695	749	853	962	1073	1232	1344	1456
	66	350	403	462	515	571	627	683	741	799	913	1034	1152	1323	1438	1558
	72	367	422	484	548	606	667	730	790	849	973	1104	1230	1410	1535	1665
	78	384	448	510	570	641	701	767	835	901	1033	1173	1306	1493	1630	1763
	84	396	463	533	602	671	735	806	877	946	1085	1233	1372	1571	1713	1859
	90	414	483	556	627	702	775	847	921	1001	1148	1298	1450	1653	1807	1959
	96	427	502	582	654	734	809	887	965	1042	1200	1362	1520	1735	1890	2052
	108	463	540	627	709	801	881	966	1051	1141	1312	1489	1663	1894	2069	2245
120	492	583	678	767	869	957	1050	1146	1237	1425	1620	1811	2054	2249	2440	

Motorized Lift Systems are not offered within the shaded area.

Widths over 108" must be built as Two-On-One Shades. Surcharge is included in shades over 108" wide

LIFT SYSTEM	UPGRADES	ADD
Cord Lock	Top Down-Bottom Up	\$64
Cordless Lift & Lock Surcharge	Bottom Up	No Extra Charge
	Top Down-Bottom Up	\$83
Cordless Ultra	Bottom Up	\$83
	Top Down-Bottom Up	\$166
Cord Loop	Bottom Up	\$83
	Top Down-Bottom Up	\$166

DESIGNER UPGRADE OPTIONS	UPGRADES	ADD
Add to Any Lift System Upgrade (Chart to the left)	Metallic Hardware	No Extra Charge
	Fabric Wrapped Hardware	No Extra Charge
	Scotchgard Stain Protection	\$35
	Highlights Valance See Page 53 For More Information	

ADDITIONAL OPTIONS	UPGRADES	ADD
Add to Any Upgrade Above	Two-On-One Head Rail	\$50 Add to Cord Lock or Cord Loop Head Rail under 108" widths
	Cut Outs	\$52 Per side
	Day-Night	Price each panel as separate shade and add together
Accessories	6 Foot Expandable Pole	\$37
	12 Foot Expandable Pole	\$46

MOTORIZATION	MORE INFO
Motorized Pricing Examples - Surcharges - Options	Pg 3
Insulating SlumberShades	\$134 See Page 37 For More Information

Color Lux® Linen Weave ¾" Light Filtering

**Price Group 3
Ovation Cellular Slider**

COLOR LUX® CELLULAR SHADES

		Width In Inches												
		24	30	36	42	48	54	60	66	72	78	84	96	120
Length In Inches	36	447	484	527	567	601	641	682	719	758	799	834	904	1047
	42	477	521	568	614	653	697	744	785	831	875	913	995	1158
	48	508	554	611	658	702	751	802	854	902	946	996	1088	1267
	54	536	591	649	704	753	806	858	918	973	1023	1076	1177	1377
	60	566	625	688	748	802	862	922	984	1041	1099	1155	1268	1485
	66	598	663	730	796	854	917	978	1052	1111	1177	1231	1360	1594
	72	632	699	769	842	910	974	1040	1117	1183	1253	1314	1456	1709
	78	663	736	813	890	961	1032	1102	1185	1256	1329	1394	1543	1815
	84	697	773	853	939	1015	1088	1165	1251	1329	1406	1474	1634	1923
	90	726	809	899	987	1064	1146	1229	1322	1402	1483	1559	1727	2039
	96	757	845	940	1033	1116	1201	1294	1388	1474	1561	1641	1820	2147
108	786	879	981	1082	1166	1256	1356	1452	1546	1641	1722	1914	2254	

Color Lux® Linen Weave ¾" Room Darkening

**Price Group 4
Ovation Cellular Slider**

		Width In Inches												
		24	30	36	42	48	54	60	66	72	78	84	96	120
Length In Inches	36	582	630	686	738	782	834	887	935	986	1039	1085	1176	1362
	42	621	678	739	799	849	907	968	1021	1081	1138	1187	1294	1506
	48	661	721	795	856	913	977	1043	1111	1173	1230	1295	1415	1648
	54	697	769	844	916	979	1048	1116	1194	1265	1330	1399	1531	1791
	60	736	813	895	973	1043	1121	1199	1280	1354	1429	1502	1649	1931
	66	778	862	949	1035	1111	1193	1272	1368	1445	1531	1601	1768	2073
	72	822	909	1000	1095	1183	1267	1352	1453	1538	1629	1709	1893	2222
	78	862	957	1057	1157	1250	1342	1433	1541	1633	1728	1813	2006	2360
	84	907	1005	1109	1221	1320	1415	1515	1627	1728	1828	1917	2125	2500
	90	944	1052	1169	1284	1384	1490	1598	1719	1823	1928	2027	2246	2651
	96	985	1099	1222	1343	1451	1562	1683	1805	1917	2030	2134	2366	2792
108	1022	1143	1276	1407	1516	1633	1763	1888	2010	2134	2239	2489	2931	

PRODUCT INFORMATION		
	See Page 25 for detailed information.	
DESIGN UPGRADES		
	Scotchgard Stain Protector	Add \$35 per shade
	Center Stack	Add \$84 Left or Right Stack Standard
	Split Stack*	Price by dividing the full width measurement in half. Price as two separate units and add together.
	Dual Panel**	Price as two separate units and add together.

* Split stack sliders are available in widths up to 240". If the width exceeds 120", it will be fabricated as two separate sliders. The supplied valance will create the appearance of a single slider.

** A Dual Panel Stack Slider has a center opening design with a different fabric on each side, each of which can span the full width of the window. Both panels will be of equal width unless otherwise specified.

Color Lux® Linen Weave 3/4" Light Filtering

Price Group 5
Starburst Arches
Quarter Rounds

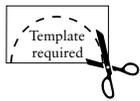

For widths wider than 58"

Fabric Wrapped or Designer Metallic Hardware Included

	Width In Inches								
	24	30	36	42	48	54	60	66	72
Non-Movable Starburst	262	295	333	376	447	508	571	642	720
Movable Starburst	363	408	462	519	617	688	772	861	959
Non-Movable Quarter Rounds	333	376	426	483	546	619			
Movable Quarter Rounds	447	504	569	640	720				

Color Lux® Linen Weave 3/4" Room Darkening

Price Group 6
Starburst Arches
Quarter Rounds

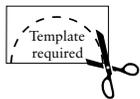

For widths wider than 58"

Fabric Wrapped or Designer Metallic Hardware Included

	Width In Inches								
	24	30	36	42	48	54	60	66	72
Non-Movable Starburst	363	406	455	511	604	683	765	857	958
Movable Starburst	494	553	623	697	825	917	1026	1142	1269
Non-Movable Quarter Rounds	455	511	576	650	732	827			
Movable Quarter Rounds	604	678	762	854	958				

Non-Movable Starburst Product Information:

Templates required on non-perfect non-movable Starburst Arches. See page 39 for more information.
 Fabric wrapped rail is standard. There will be a splice in the center. A decorative rosette is supplied to cover the splice.

Pricing Information:

Price according to the largest radius measurement. If the height is greater than the width, take height multiplied by 2 and use that number to determine pricing.

FABRIC SURCHARGES		ADD
Scotchgard Stain Protector		\$35
PRICING INFORMATION		
Starburst Arches	Price according to the largest radius measurement. If the height is greater than the width, take height X 2 and use that number to determine pricing. Metallic rails available.	
Quarter Rounds	Price according to the largest radius measurement.	
HARDWARE UPGRADE SURCHARGES* AND ACCESSORIES		ADD
Metallic Hardware or Fabric Wrapped Rails		No Extra Charge
6 Foot Expandable Pole		\$37
12 Foot Expandable Pole		\$46

Color Lux® Linen Weave 3/4" Light Filtering

Price Group 7
Sunset Movable Arches
Fabric Wrapped or Designer Metallic Hardware Included

		Width In Inches								
		24	30	36	42	48	54	60	66	72
Half Round		334	369	390	436	464	518	548	601	655
	36	426	465	486	519	541	579	596	626	655
	42	448	493	512	562	580	623	643	679	708
	48	474	519	546	594	616	651	690	726	764
	60	517	579	606	668	697	755	785	830	874

Sunset Product Information:

Templates required on non-perfect Sunset Arches. See page 43.

Color Lux® Linen Weave 3/4" Room Darkening

Price Group 8
Sunset Movable Arches
Fabric Wrapped or Designer Metallic Hardware Included

		Width In Inches						
		24	30	36	42	48	54	60
Half Round		428	474	501	561	597	667	706
	36	548	598	626	669	697	747	769
	42	576	635	659	724	748	804	830
	48	610	669	704	766	795	840	891
	60	666	747	782	862	900	975	1014

Sunset Product Information:

Templates required on non-perfect Sunset Arches. See pages 43.

PRODUCT INFORMATION		
	See Page 42 for detailed information.	
DESIGN UPGRADES		
	Scotchgard Stain Protector	Add \$35 per shade
	6 Foot Expandable Pole	Add \$37
	12 Foot Expandable Pole	Add \$46

Color Lux® Linen Weave 3/4" Light Filtering

Price Group 9
Trapezoids and Octagons
Fabric Wrapped or Designer Metallic Hardware Included

COLOR LUX® CELLULAR SHADES

Length In Inches	Width In Inches						
	24	30	36	42	48	54	60
36	452	479	510	545	575	604	633
42	468	499	534	571	604	638	674
48	482	518	559	598	633	671	710
54	498	536	580	622	662	705	745
60	514	556	603	648	691	741	785
66	530	575	626	675	724	774	819
72	545	593	648	702	755	807	861

Color Lux® Linen Weave 3/4" Room Darkening

Price Group 10
Trapezoids and Octagons
Fabric Wrapped or Designer Metallic Hardware Included

Length In Inches	Width In Inches						
	24	30	36	42	48	54	60
36	581	617	657	702	741	779	817
42	602	643	688	736	779	823	870
48	620	667	721	771	817	866	917
54	641	691	748	802	854	910	962
60	662	717	778	836	892	957	1014
66	683	741	808	871	935	1000	1059
72	702	765	836	906	975	1043	1113

PRODUCT INFORMATION	
	See page 44 for detailed information. Width, length and one side are required measurements for Octagon Shades. Trapezoid orders must be faxed in with a diagram that includes the measurements for 4 sides.
DESIGN UPGRADES	
Scotchgard Stain Protector	Add \$35 per shade

Color Lux® Linen Weave 3/4" Light Filtering

Price Group 11 Mezzo Motorized Skylights White Rail and White Track

		Width In Inches				
		24	30	36	42	48
Length In Inches	36	406	459	510	570	618
	42	429	487	552	610	677
	48	451	522	585	652	724
	54	478	551	623	693	782
	60	495	581	657	736	838
	66	522	607	690	773	892
	72	551	642	720	803	941

Be sure to add the Simplicity motor surcharges and upgrades to the grid above.

Color Lux® Linen Weave 3/4" Room Darkening

Price Group 12 Mezzo Motorized Skylights White Rail and White Track

		Width In Inches				
		24	30	36	42	48
Length In Inches	36	522	591	657	735	797
	42	552	627	711	787	874
	48	580	672	754	841	935
	54	615	710	804	895	1010
	60	637	749	848	951	1083
	66	672	783	891	999	1153
	72	710	828	930	1038	1217

Be sure to add the Simplicity motor surcharges and upgrades to the grid above.

MOTORIZED	UPGRADES	ADD	
Simplicity Motorization System	Motor and Battery Wand	\$334	For More Information Page 27
	Simplicity 5 Channel Remote	\$40	
	Simplicity 6 Channel Remote	\$65	
	48" Extension Wire	\$18	
	DC Power Supply/Transformer	\$63	
	Solar Panel Recharge Kit : Includes Solar Panel with brackets, rechargeable battery wand with clips and Y cable	\$173	
Simplicity Rechargeable Motorization System	Motor and Battery Wand	\$334	For More Information Page 29
	Simplicity 5 Channel Remote	\$40	
	Simplicity 6 Channel Remote	\$65	
	Plug-In Charger for Rechargeable Li-Ion	\$27	
Simplicity Smart Controller System	NEO Controller	\$330	For More Information Page 32
	NEO Application for Mobile Devices	FREE	

Color Lux® Linen Weave 3/4" Light Filtering

Price Group 13

Non-Movable Door Decors

Fabric Wrapped or Designer Metallic Hardware Included

		Width In Inches				
		12	18	24	30	36
Length In Inches	36	108	114	120	133	148
	42	115	121	127	142	157
	48	121	128	134	151	169
	54	126	133	140	158	180
	60	135	142	149	168	190
	66	141	149	156	178	202
	72	146	154	162	185	212
	78	153	161	169	194	221
	84	158	167	175	203	231
	90	164	173	182	211	241
	96	169	178	187	218	251

COLOR LUX® CELLULAR SHADES

Color Lux® Linen Weave 3/4" Room Darkening

Price Group 14

Non-Movable Door Decor

Fabric Wrapped or Designer Metallic Hardware Included

		Width In Inches				
		12	18	24	30	36
Length In Inches	36	135	142	149	166	186
	42	143	151	159	178	198
	48	151	160	168	190	213
	54	158	167	175	199	227
	60	169	178	187	212	240
	66	177	187	196	225	256
	72	184	194	204	234	269
	78	192	203	213	246	281
	84	199	210	221	257	294
	90	207	219	230	268	307
	96	213	225	237	277	320

PRODUCT INFORMATION		
	See Page 49 for detailed information.	
DESIGN UPGRADES		
	Scotchgard Stain Protector	Add \$35 per shade
	6 Foot Expandable Pole	Add \$37
	12 Foot Expandable Pole	Add \$46

Color Lux® Linen Weave 3/4" Light Filtering

Price Group 15
Movable Door Decors
Fabric Wrapped or Designer Metallic Hardware Included

		Width In Inches				
		12	18	24	30	36
Length In Inches	36	195	206	216	240	267
	42	207	218	229	256	283
	48	218	231	242	272	305
	54	227	240	252	285	324
	60	243	256	269	303	342
	66	254	269	281	321	364
	72	263	278	292	333	382
	78	276	290	305	350	398
	84	285	301	315	366	416
	90	296	312	328	380	434
96	305	321	337	393	452	

Color Lux® Linen Weave 3/4" Room Darkening

Price Group 16
Movable Door Decor
Fabric Wrapped or Designer Metallic Hardware Included

		Width In Inches				
		12	18	24	30	36
Length In Inches	36	243	256	269	300	335
	42	258	272	286	321	356
	48	272	288	302	342	384
	54	285	301	316	358	410
	60	305	321	337	382	433
	66	319	337	354	405	461
	72	332	350	368	422	485
	78	346	366	384	443	506
	84	359	378	398	464	529
	90	373	395	414	482	553
96	384	405	426	499	576	

PRODUCT INFORMATION		
	See Page 49 for detailed information.	
DESIGN UPGRADES		
	Scotchgard Stain Protector	Add \$35 per shade
	6 Foot Expandable Pole	Add \$37
	12 Foot Expandable Pole	Add \$46

Color Lux® Cellular Shade Head Rail Options

STANDARD CORD LOCK SHADES



Cord Lock Rail

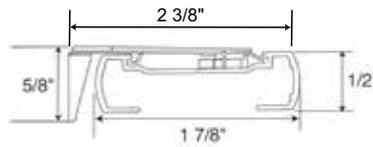

Cord Lock Rail

- Depth of rail: 1 7/8"
- Depth of rail and bracket: 2 3/8"
- Height: 1/2"
- Height of bracket: 5/8"

Hardware Features	
Fabric Wrapped	Fabric used is same fabric as the shade. Back of rail is white to outside. Color coordinated end caps with white cord and tassel
Designer Metallic	<ul style="list-style-type: none"> • Oil Rubbed Bronze head and bottom rails with bronze colored tassel, end caps and white cord. • Brushed Nickel head and bottom rails and end caps with coordinating tassel and white cord.
Mounting Dimensions	
Minimum Shallow Mount	3/4"
Minimum Flush Inside Mount	2 3/8"
Minimum Outside Mount	3/4"
Minimum Side Mount	1 3/8"
Recommended Side Mounting Method	<ul style="list-style-type: none"> • See figure B for recommended mounting method for side mount shades • Width limit for side mount brackets is 48"
Finished Dimensions	
Inside and Side Mount	
	<ul style="list-style-type: none"> • Fabric will measure ordered width less: 3/8" • Head rail* will measure ordered width less: 3/16"
Outside Mount	
	<ul style="list-style-type: none"> • Fabric will measure ordered width • Head rail* will measure ordered width plus: 3/16"
Exact (End Cap to End Cap) Mount	
	<ul style="list-style-type: none"> • Fabric will measure ordered width less: 3/16" • Head rail* will measure ordered width
* Head rail measurements include endcaps. Width and length measurements may vary +/- 1/8"	

Color Lux® Cellular Shades STANDARD CORD LOCK SHADES

Applications

- Standard Rectangular
- Day-Night
- Trapezoids and Octagons
- Top Down - Bottom Up
- Two-On-One Head Rail

Highlights Cornice Valance

Add a designer finishing touch to a cellular shade with a Highlights Cornice Valance. See page 53 for details.

Two-On-One Head Rail with Splicer

- Two-On-One Head Rail shades can also be made using two standard rectangular shades joined by a 6" splicer. (See Figure A below). A retail surcharge does not apply to Two-On-One shades with a splicer.

Two-On-One Headrail with Splicer

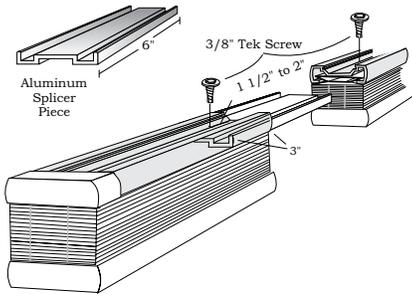

Figure A

Things to Consider

- If child safety is a concern, consider cordless options: Cordless Ultra, Cordless Lift & Lock or Motorization.
- Larger shades can be difficult to operate. Consider Cord Loop, Cordless Ultra or Motorization hardware.
- If privacy is an issue, consider Top Down-Bottom Up options.

Recommended Mounting Method for Side Mount Shades

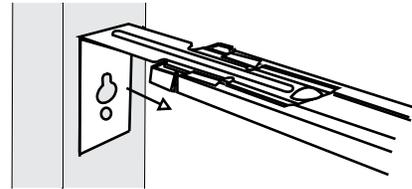

Figure B

EZ Level on Cellular Shades

EZ Level makes quick work of leveling without cords to cut or tuck into a rail. See page 53 for details.

Day-Night Shades

See pages 51-52 for more information.

Specialties (Trapezoids and Octagons)

See pages 44-45 for more information.

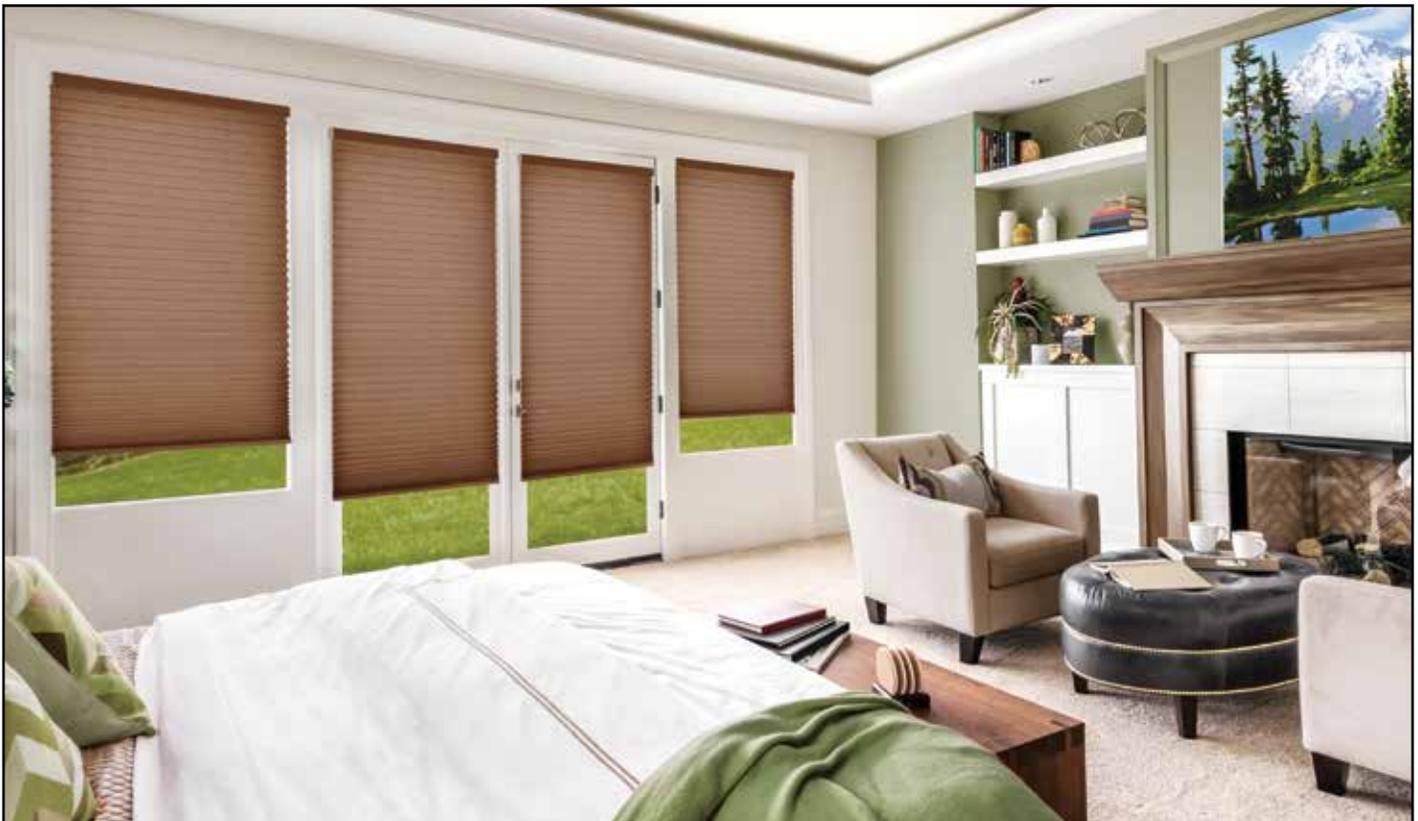

Color Lux® Cellular Shade Head Rail Options

CORD LOOP HARDWARE SYSTEM

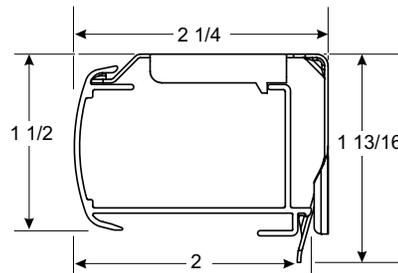

Cord Loop Rail Dimensions

- Depth of rail: 2"
- Depth of rail and bracket: 2 1/4"
- Height of rail: 1 1/2"
- Height of bracket: 1 13/16"

Hardware Features	
Fabric Wrapped	Fabric used is same fabric as the shade. Back of rail is white to outside. Clutch cover will be white. Frosted clear with fabric insert end caps with white cord and tassel.
Designer Metallic	<ul style="list-style-type: none"> • Oil Rubbed Bronze head and bottom rails with bronze colored tassel, end caps and white cord. • Brushed Nickel head and bottom rails and end caps with coordinating tassel and white cord.

Mounting Dimensions	Cord Loop Hardware System
Minimum Shallow Mount	1/2"
Minimum Flush Inside Mount	2 1/4"
Minimum Outside Mount	7/8"
Minimum Side Mount	1 1/4"
Recommended Side Mounting Method	<ul style="list-style-type: none"> • See figure A for recommended mounting method for side mount shades • Width limit for side mount brackets is 48"

Finished Dimensions	
Inside Mount	
	<ul style="list-style-type: none"> • Fabric will measure ordered width less: 3/8" • Head rail* will measure ordered width less: 3/16"
Outside Mount	
	<ul style="list-style-type: none"> • Fabric will measure ordered width • Head rail* will measure ordered width plus: 3/16"
Side Mount	
	<ul style="list-style-type: none"> • Fabric will measure ordered width less: 7/8" • Head rail* will measure ordered width less: 1 1/16"
Exact (End Cap to End Cap) Mount	
	<ul style="list-style-type: none"> • Fabric will measure ordered width less: 3/16" • Head rail* will measure ordered width

* Head rail measurements include endcaps. Width and length measurements may vary +/- 1/8"

Color Lux® Cellular Shades

CORD LOOP SHADES

Applications

- Standard Rectangular
- Two-On-One Head Rail
- Top Down - Bottom Up

Cord Loop Hardware System Features

Cord loops are available 2' to 15' lengths in 1' intervals. Please specify length when ordering. Standard loop sizes are as follows:

Shade Length	Standard Loop
Up to and including 26 ⁷ / ₈ "	1' (12")
27" to 39 ⁷ / ₈ "	2' (24")
40" to 59 ⁷ / ₈ "	3' (36")
60" to 83 ⁷ / ₈ "	4' (48")
84" to 107 ⁷ / ₈ "	5' (60")
108" and greater	6' (72")

Recommended Mounting Method for Side Mounting Shades

Width limit for side mount brackets is 48".

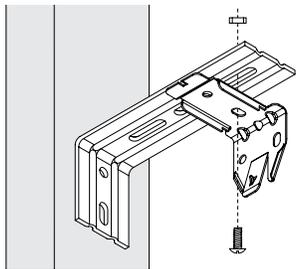

Cord Loop Hardware
Cordless Ultra Hardware
Cordless Ultra Top Down -
Bottom Up Hardware

Figure A

Refer to the installation instructions on Comfortexdealers.com or the OnDemand Mobile Library for further details on side mounting shades.

Ordering Information for Cord Loop Hardware Shades

Standard Rectangular

- Specify IB or OB mount, rail color and left or right lift cord.
- Specify cord loop length when ordering.

Top Down - Bottom Up

- Specify IB or OB mount and rail color. Middle rail will match the top and bottom rails.
- Specify cord loop length when ordering.
- Controls are the right cord loop operates the middle rail and left cord loop operates the bottom. Reverse controls are not available.

Two-On-One Head Rail

- Two-On-One Head Rail Shades operate as two separate shades on one head rail.
- Specify IB or OB mount and rail color.
- Specify panel sizes.
- Specify cord loop length when ordering.
- ³/₈" Space between panels.
- Fabric wrapped Two-On-One Shades will have a seam in the center of the rail due to the wide width.

Highlights Cornice Valance

Add a designer finishing touch to a cellular shade with a Highlights Cornice Valance. See page 53 for details.

EZ Level on Comfortex Cellular Shades

EZ Level makes quick work of leveling without cords to cut or tuck into a rail. No special tools needed – just use a nickel, quarter or penny to adjust plug on the bottom rail.

EZ Level is standard on all Cellular and Pleated Shades with the following hardware systems:

Standard Cord Lock, Cordless Ultra, Cord Loop Simplicity Motorized Systems

EZ Level is not available with Cordless Lift & Lock.

How does EZ Level work?

- Slightly raise the bottom rail you want to level.
- Insert a coin or flat head screwdriver into the adjustment screw and turn it.
- Turn the adjustment screw clockwise or counter clockwise to make slight adjustments up or down. One quarter turn of the adjustment screw will move the bottom rail up or down ¹/₄".
- Lower the rail to check the level and make further adjustments if necessary.



Color Lux® Cellular Shade Head Rail Options

CORDLESS ULTRA HARDWARE SYSTEM

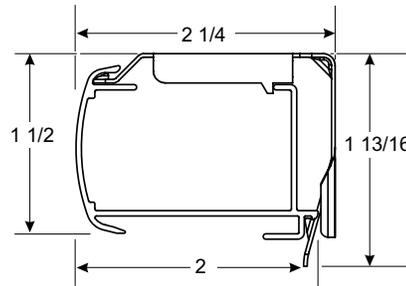

Cord Loop Rail Dimensions

- Depth of rail: 2"
- Depth of rail and bracket: 2 1/4"
- Height of rail: 1 1/2"
- Height of bracket: 1 13/16"

Hardware Features	
Fabric Wrapped	Fabric used is same fabric as the shade. Back of rail is white to outside. Frosted clear with fabric insert end caps with white cord and tassel.
Designer Metallic	<ul style="list-style-type: none"> • Oil Rubbed Bronze head and bottom rails with bronze colored tassel, end caps and white cord. • Brushed Nickel head and bottom rails and end caps with coordinating tassel and white cord.
Mounting Dimensions	Cord Loop Hardware System
Minimum Shallow Mount	1/2"
Minimum Flush Inside Mount	2 1/4"
Minimum Outside Mount	7/8"
Minimum Side Mount	1 1/4"
Recommended Side Mounting Method	<ul style="list-style-type: none"> • See figure A, page 20 for recommended mounting method for side mount shades • Width limit for side mount brackets is 48"
Finished Dimensions	
Inside Mount	
	<ul style="list-style-type: none"> • Fabric will measure ordered width less: 3/8" • Head rail* will measure ordered width less: 3/16"
Outside Mount	
	<ul style="list-style-type: none"> • Fabric will measure ordered width • Head rail* will measure ordered width plus: 3/16"
Side Mount	
	<ul style="list-style-type: none"> • Fabric will measure ordered width less: 7/8" • Head rail* will measure ordered width less: 1 1/16"
Exact (End Cap to End Cap) Mount	
	<ul style="list-style-type: none"> • Fabric will measure ordered width less: 3/16" • Head rail* will measure ordered width
* Head rail measurements include endcaps. Width and length measurements may vary +/- 1/8"	

Color Lux® Cellular Shades CORDLESS ULTRA SHADES

Applications

- Standard Rectangular
- Top Down - Bottom Up

Things to Consider

- Is the top of your window out of reach? You can order an extension pole to reach but it can still be tricky. You may want to consider Cord Loop or Motorized hardware.
- For shades mounted on doors, you may want to order hold down brackets.
- If privacy is an issue, consider Top Down-Bottom Up options.

Ordering Information for Cordless Ultra Hardware Shades

Standard Rectangular

- Specify IB or OB mount and rail color.

Top Down - Bottom Up

- Specify IB or OB mount and rail color. Middle rail will match the head and bottom rails.

Accessories

- 6' Expandable Pole: \$37.00
- 12' Expandable Pole: \$46.00

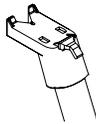

Specially designed pole end fits into the handle on the bottom rail and allows for easy operation.

Cordless Ultra and Cordless Ultra Top Down - Bottom Up Hardware Features

- Children and pets have safer surroundings in homes that have window shades without operating cords, reducing the risk of strangulation.
- Cordless Ultra and Cordless Ultra Top Down - Bottom Up Shades can be raised or lowered with a gentle push or pull on the rail handle.
- Cordless Ultra Top Down - Bottom Up Shades feature two moving rails.
- Order an operating pole for out of reach applications.



Fabric Wrapped Head Rail and Designer Metallic Head Rails.

Cordless Ultra Shade Operation

Cordless shades should be operated from the handle located in the center of the bottom rail. Using the handle will aid in smooth and easy shade operation. Two handles are supplied on wider width shades.

To lower the shade, pull down on the handle which is secured to the bottom rail and guide the rail to desired position (Figure A). For out of reach applications, an optional extension pole should be used.

To raise the shade, push the bottom rail up using the handle on the bottom rail and guide the rail to the desired position. The shade will hold any position when the bottom rail is released. Raise the shade slowly and steadily to allow the shade to stack evenly (Figure B).

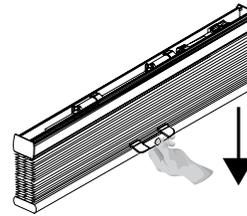

Figure A

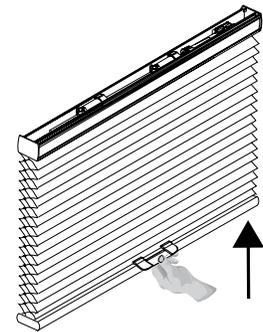

Figure B



Clear Cordless Handle

Recommended Mounting Method for Side Mounting Shades

See Page 20.

Highlights Cornice Valance

Add a designer finishing touch to a cellular shade with a Highlights Cornice Valance. See page 53 for details.

EZ Level on Cellular Shades

EZ Level makes quick work of leveling without cords to cut or tuck into a rail. See page 53 for details.

Color Lux® Cellular Shade Head Rail Options CORDLESS LIFT & LOCK HARDWARE SYSTEM



Cordless Lift & Lock Head Rail

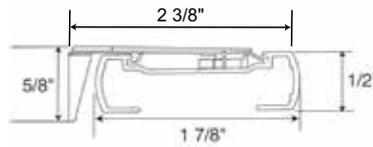

Cordless Lift & Lock Rail

- Depth of rail: 1 7/8"
- Depth of rail and bracket: 2 3/8"
- Height: 1/2"
- Height of bracket: 5/8"

Hardware Features	
Hardware	<ul style="list-style-type: none"> • Fabric wrapped head, middle and bottom rails. All shades will have a white push button/handle on the middle/bottom rail. • End caps on all rails will be white. • Fabric used to cover the rails is the same fabric as the shade. The back of the rail will be white to the outside.
Upgrades	
Designer Metallic Upgrade	<ul style="list-style-type: none"> • Smooth faced Designer Oil Rubbed Bronze Metallic head, middle and bottom rail and end caps. • Oil Rubbed Bronze push button/handle on the middle or bottom rails.
Mounting Dimensions	
	Lift & Lock Head Rail
Minimum Shallow Mount	3/4"
Minimum Flush Inside Mount	2 1/2"
Minimum Outside Mount	3/4"
Minimum Side Mount	1 3/8"
Recommended Side Mounting Method	<ul style="list-style-type: none"> • See figure A (pg 20) for recommended mounting method for side mount shades • Width limit for side mount brackets is 48"
Finished Dimensions	
Inside and Side Mount	
	<ul style="list-style-type: none"> • Fabric will measure ordered width less: 3/8" • Head rail* will measure ordered width less: 3/16"
Outside Mount	
	<ul style="list-style-type: none"> • Fabric will measure ordered width • Head rail* will measure ordered width plus: 3/16"
Exact (End Cap to End Cap) Mount	
	<ul style="list-style-type: none"> • Fabric will measure ordered width less: 3/16" • Head rail* will measure ordered width
<p>* Head rail measurements include endcaps. Width and length measurements may vary +/- 1/8"</p>	

Color Lux® Cellular Shades

CORDLESS LIFT & LOCK SHADES

Cordless Lift & Lock Shades Hardware System

Bottom Rail Dimensions

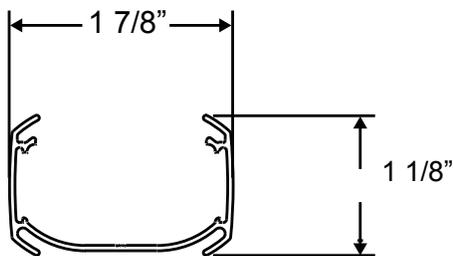

- Depth of rail: 1 7/8"
- Height of rail: 1 1/8"

Applications

- Standard Rectangular
- Top Down-Bottom Up

Important Operating Note on Cordless Lift & Lock Shades

- To operate a Cordless Lift & Lock Shade, the middle or bottom rails must be accessible. An extension pole is not available for Cordless Lift & Lock Shades.
- If the bottom or middle rail is not accessible, you may want to consider Cord Loop, Cordless Ultra or Motorized hardware. An extension pole is not available for Cordless Lift & Lock Shades.
- For shades mounted on doors, you may want to order hold down brackets.

Cordless Lift & Lock Hardware Features

- Children and pets have safer surroundings in homes that have window shades without operating cords, reducing the risk of strangulation.
- Cordless Lift & Lock Shades can be raised or lowered by pressing the button located on the bottom rail and guiding the rail into the desired location.

Leveling the Bottom Rails

Each Cordless Lift & Lock Shade includes a skew adjustment leveling tool hidden in the bottom rail of each shade.

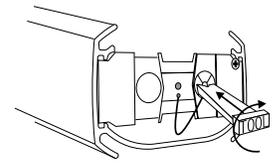

To level the bottom rail, remove the bottom rail end cap to access the tool which allows you to adjust the placement of the bottom rail. Adjustment instructions are supplied with each shade.

Ordering Information for Cordless Lift & Lock Shades

Standard Rectangular

- Specify IB or OB mount and rail color.

Cordless Lift & Lock Shade Operation

Cordless Lift & Lock Shades are operated using the push button handle located in the center of the bottom rail.

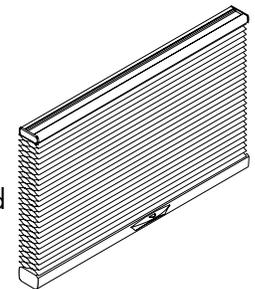

To raise or lower the shade; press the button on the shade handle, and guide the rail to desired position. Release the button to lock the shade into place.

The shade will in hold any position when the button is released. Raise the shade slowly and steadily to allow the shade to stack evenly.

Recommended Mounting Method for Side Mounting Shades

See Page 20.

Highlights Cornice Valance

Add a designer finishing touch to a cellular shade with a Highlights Cornice Valance. See page 53 for details.



Fabric Wrapped Head Rail with White End Caps



Fabric Wrapped Bottom Rail with White push button/handle



Oil Rubbed Bronze Head Rail and End Caps



Oil Rubbed Bottom Rail and push button/handle

Color Lux® Cellular Shade Head Rail Options

OVATION CELLULAR SLIDER

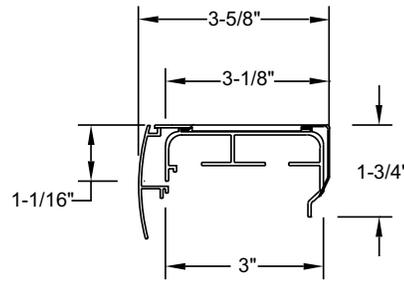

Ovation Hardware Rail Dimensions

- Depth of rail: 3"
- Depth of rail and bracket: 3 1/8"
- Height of rail: 1 3/4"

Hardware Features	
Standard Hardware Color	Aspen White #785
Optional Hardware Colors	Ivory, beige, tan and gray rails are available as an option. Visit comfortexdealers.com to view color options <ul style="list-style-type: none"> • Silverado #276 • Honey Bisque #882 • Camel #082 • Gardenia White #862
Mounting Dimensions	
Minimum Inside Mount	3/4"
Minimum Flush Mount	3 5/8"
Minimum Outside Mount	5/8"
Finished Dimensions	
Inside Flush Mount	
Track Width:	
Right or Left Stack	3/16" less than ordered width
Split Stack	3/16" less than ordered width
Center Stack	3/16" less than ordered width
Finished Slider Length	1/2" less than ordered width
Valance	3/16" less than ordered width
Outside Mount	
Track Width	Ordered width
Finished Slider Length	Ordered length - No reductions will be made
Valance	Ordered width plus 1 1/4"
Valance Returns	Will measure 3 1/8" (standard)

Color Lux® Cellular Shades OVATION CELLULAR SLIDER

Applications

- Standard Rectangular
- Opens and closes from side to side
- Four stacking options - see below.
- Dual Panel option with a center opening design with two fabrics, one on each side, each spanning the width of the window.

Ovation Stacking Options

Specify stacking configuration when ordering.

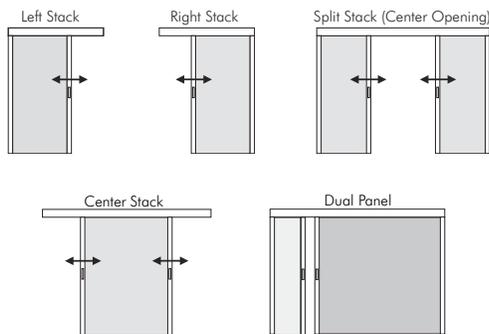

Left: Fabric stacks to the left side of the slider.

Right: Fabric stacks to the right side of the slider.

Center Stack: Center Stack Sliders fabric panels can move fully to the left or the right.

Split Stack: Fabric is split in the center of the slider forming two equal panels which open to opposite ends of the slider. Both panels will be of equal width unless otherwise specified. Split stack is not available with Gradient shades.

* Split stack sliders are available in maximum widths from 240" to 336" (maximum width depends on the fabric selected). If the width exceeds the maximum width of the fabric, it will be fabricated as two separate sliders. The supplied valance will create the appearance of a single slider.

Dual Panel: A Dual Panel Stack Slider has a center opening design with a different fabric on each side, each of which can span the full width of the window. Both panels will be of equal width unless otherwise specified. Specify which fabric stacks to left and which fabric stacks to the right.

Ordering Information for Ovation Cellular Sliders

- Specify IB or OB mount.
- Specify stacking configuration.
On Dual Panel Shades, specify which fabric stacks to the left and right.
On Split Stack Shades, both panels will be of equal width unless specified.
- Specify valance width and return length.

Ovation Valance Specifications

- Every Ovation Slider is supplied with a painted aluminum valance to match your hardware color choice.
- The valance attaches to the head rail using a durable plastic clip system.

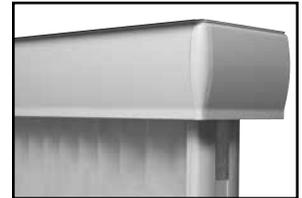

Ovation Valance Dimensions

All valance dimensions are measured on the flat, back side.

- Valance Height: 2¾"
- Standard Return Length (OB only): 3⅛"
- For each spacer block, ½" will be added to the length of the valance returns. For extension brackets, 2" will be added unless otherwise instructed.
- If the slider requires a non-flush inside mount, you must order a custom valance. Exact valance width and exact valance return length (minimum 1½") must be specified in the Special Instructions section of the order form.
- Custom returns are available for IB non-flush and OB Cellular Sliders. Please specify return length upon ordering.

Things to Consider

- Since most Ovations are sold in large sizes, the shade will have a large fabric stack. On an outside mount, you may want to order the shade a few inches wider so that the fabric stack can be clear of the window.
- **Minimum Ovation Stack:** Ovation's minimum fabric stack measures 6½" regardless of the ordered width. Minimum fabric stacking dimensions are determined by the slider's hardware, not ordered width.

Color Lux® Cellular Shade Hardware Options
SIMPLICITY MOTORIZED CELLULAR SHADES

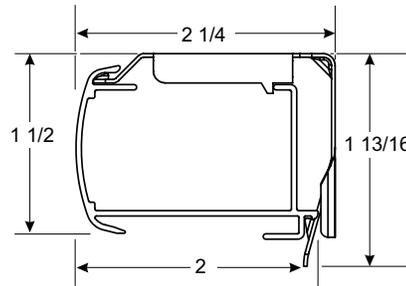

Simplicity Motorized Rail Dimensions

- Depth of rail: 2"
- Depth of rail and bracket: 2 1/4"
- Height of rail: 1 1/2"
- Height of bracket: 1 13/16"

Hardware Features	
Standard Hardware	<ul style="list-style-type: none"> • Fabric Wrapped head and bottom rails. Head rail and Bottom rails will have frosted end caps with fabric inserts. • Fabric used to cover the rails is the same fabric as the shade. The back of the rail will be white to the outside.
Simplicity Remote	Upper and lower limit stops pre-programmed, Intermediate stop "favorites" position can be set on site.
Upgrades	
Designer Metallic Upgrade	<ul style="list-style-type: none"> • Smooth faced Designer Oil Rubbed Bronze head, middle, bottom rails and end caps • Smooth faced Designer Brushed Nickel head, middle, bottom rails and end caps
Mounting Dimensions	
Minimum Shallow Mount	1/2"
Minimum Flush Inside Mount	2 1/4"
Minimum Outside Mount	7/8"
Minimum Side Mount	1 1/4"
Recommended Side Mounting Method	<ul style="list-style-type: none"> • See page 20 for recommended mounting method for side mount shades • Width limit for side mount brackets is 48"
Finished Dimensions	
Inside Mount	
	<ul style="list-style-type: none"> • Fabric will measure ordered width less: 3/8" • Head rail* will measure ordered width less: 3/16"
Outside Mount	
	<ul style="list-style-type: none"> • Fabric will measure ordered width • Head rail* will measure ordered width plus: 3/16"
Side Mount	
	<ul style="list-style-type: none"> • Fabric will measure ordered width less: 7/8" • Head rail* will measure ordered width less: 1 1/16"
Exact (End Cap to End Cap) Mount	
	<ul style="list-style-type: none"> • Fabric will measure ordered width less: 3/16" • Head rail* will measure ordered width
* Head rail measurements include endcaps. Width and length measurements may vary +/- 1/8"	

Color Lux® Cellular Shades SIMPLICITY MOTORIZED CELLULAR SHADES

Simplicity Motors

The Simplicity Motor program features a battery powered motor utilizing a single battery wand or plug-in DC transformer. Simplicity motors are compact and use a radio frequency remote to raise or lower the shades.

Motorized Lift Systems are not offered on sizes within the shaded area on the Standard Rectangular price grids.

- Length measurements may vary +/- 1/8".

Applications

- Standard Rectangular

EZ Level

Learn about the EZ Level feature on page 53.

Simplicity Motorization Surcharges

The standard Simplicity Motorized Lift System surcharge includes a 12 volt battery wand with eight AA batteries. Remotes are needed to operate the shades. See pricing pages.

Important Simplicity Motorized Shade Operating and Installation Information

- Simplicity Motorized Shades installed into windows with metal casings may have a reduced radio frequency range, or may not operate at all, depending on the application.
- Do not let the antenna on the motor touch any metal objects. This may interfere with signals from the remote control.

SIMPLICITY MOTORIZATION PRICING EXAMPLE:

Color Lux	
Light Filtering 42" x 60" Shade:	\$361.00
Simplicity Motor Surcharge:	\$334.00
Simplicity Remote Control:	\$40.00
Total List Price:	\$735.00

Simplicity Battery Wand

Batteries are needed to operate Simplicity motors. The battery wand can be clipped to the head rail or wall or ceiling mounted utilizing white battery wand clips. The 12 volt battery wand measures 17 1/4", and comes with eight AA alkaline batteries, and is white in color.

The battery wire is 10" long. A 48" extension wire is available.



Simplicity Motor Battery Life and Replacement

Eight alkaline batteries are included with the wand.

The battery life will vary based on the type of window covering selected, the size and weight of the window covering and the number of times you operate the shade on a daily basis. For example, a 36" x 60" single honeycomb shade operated twice daily will commonly have a battery life which lasts up to 18 months.

Comfortex will warranty batteries for up to 3 months from date of purchase.

Simplicity Hand Held Remotes

The 5 Channel remote can operate up to five shades simultaneously, individually or 5 groups.

WHEN ORDERING PLEASE SPECIFY WHICH CHANNELS ARE ASSIGNED TO EACH SHADE OR GROUP OF SHADES.

For example; program line 1 to channel 1, line 2 and 3 to channel 2, etc. If no channels are assigned at time of order, all shades will be programmed to Channel 1. **To reprogram channel assignments, please refer to the installation instructions and/or view the video at comfortexdealers.com/products/motortechsupport.html.**



Simplicity remotes and holders are black or white in color. The remote comes with a holder which can be mounted to a wall for easy storage. The range of the remote is approximately 80 feet.

The Simplicity remote utilizes one 3V battery (CR2032). Batteries are included. Comfortex will warranty batteries for up to 3 months from date of purchase.

A **6 Channel (6C) timer remote** is also available. See page 31 for more information.

DC Power Supply/Transformer

12 Volt DC power supply/transformer is available and requires a standard power outlet to power the motor. The transformer is an alternative to a battery wand. Each transformer can power a single shading. The power supply must plug in to the motor. The DC power supply is white and comes with a 80" wire. The dimensions are 1 7/8" wide x 3 1/4" long x 1 1/4" deep



Color Lux® Cellular Shade Hardware Options

SIMPLICITY RECHARGEABLE MOTORIZED CELLULAR SHADES

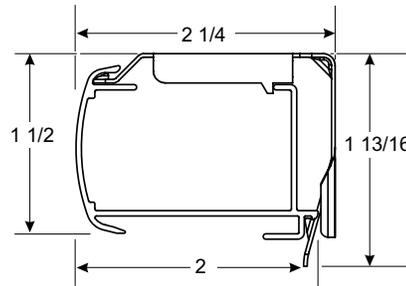

- Simplicity Rechargeable Rail Dimensions**
- Depth of rail: 2"
 - Depth of rail and bracket: 2 1/4"
 - Height of rail: 1 1/2"
 - Height of bracket: 1 13/16"

Hardware Features	
Standard Hardware	<ul style="list-style-type: none"> • Fabric Wrapped head and bottom rails. Head rail and Bottom rails will have frosted end caps with fabric inserts. • Fabric used to cover the rails is the same fabric as the shade. The back of the rail will be white to the outside.
Simplicity Remote	Upper and lower limit stops pre-programmed, Intermediate stop "favorites" position can be set on site.
Upgrades	
Designer Metallic Upgrade	<ul style="list-style-type: none"> • Smooth faced Designer Oil Rubbed Bronze head, middle, bottom rails and end caps • Smooth faced Designer Brushed Nickel head, middle, bottom rails and end caps
Mounting Dimensions	
Simplicity Rechargeable Motorization Hardware System	
Minimum Shallow Mount	1/2"
Minimum Flush Inside Mount	2 1/4"
Minimum Outside Mount	7/8"
Minimum Side Mount	1 1/4"
Recommended Side Mounting Method	<ul style="list-style-type: none"> • See page 20 for recommended mounting method for side mount shades • Width limit for side mount brackets is 48"
Finished Dimensions	
Inside Mount	
	<ul style="list-style-type: none"> • Fabric will measure ordered width less: 3/8" • Head rail* will measure ordered width less: 3/16"
Outside Mount	
	<ul style="list-style-type: none"> • Fabric will measure ordered width • Head rail* will measure ordered width plus: 3/16"
Side Mount	
	<ul style="list-style-type: none"> • Fabric will measure ordered width less: 7/8" • Head rail* will measure ordered width less: 1 1/16"
Exact (End Cap to End Cap) Mount	
	<ul style="list-style-type: none"> • Fabric will measure ordered width less: 3/16" • Head rail* will measure ordered width
* Head rail measurements include endcaps. Width and length measurements may vary +/- 1/8"	

Color Lux® Cellular Shades

SIMPLICITY RECHARGEABLE MOTORIZED CELLULAR SHADES

Rechargeable Simplicity Motors

The Simplicity Motor program features a battery powered motor utilizing a rechargeable battery hidden inside the shade head rail. Simplicity motors are compact and use a radio frequency remote to raise or lower the shades.

Rechargeable Motorized Lift Systems are not offered on sizes within the shaded area on the Standard Rectangular price grids.

Applications

- Standard Rectangular

EZ Level

Learn about the EZ Level feature on page 53.

Rechargeable Simplicity Motorization Surcharges

The Rechargeable Simplicity Motorized Lift System surcharge includes a rechargeable battery. Remotes are needed to operate the shades. Refer to pricing pages.

Important Simplicity Motorized Shade Operating and Installation Information

- Simplicity Motorized Shades installed into windows with metal casings may have a reduced radio frequency range, or may not operate at all, depending on the application.
- Do not let the antenna on the motor touch any metal objects. This may interfere with signals from the remote control.

SIMPLICITY RECHARGEABLE BATTERY WAND PRICING EXAMPLE:

Linen Weave	
Light Filtering 42" x 60" Shade:	\$350.00
Simplicity Rechargeable Surcharge:	\$334.00
Charger for Rechargeable :	\$27.00
Simplicity Remote Control:	\$40.00
Total List Price:	\$751.00

Simplicity Rechargeable Battery

The rechargeable battery is concealed in the head rail of the shade. A charger is required for the rechargeable battery. The rechargeable battery comes fully charged from the factory.

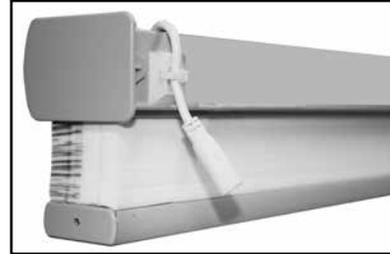

Charging Port on Back of Head rail.

Retrofit Existing Standard Simplicity Motorized Shades with Rechargeable Batteries

Cellular shades made with Standard Simplicity Motorization can be retrofitted with the Rechargeable Simplicity Motorization Battery Wand. The Rechargeable battery wand is 22" long, comes with 10 NiMH batteries, and is white in color. Battery wands are charged at the factory.

To retrofit the rechargeable battery wand to an existing shade with a cassette head rail, you must have at least 24" between bracket centerlines to fit the battery wand. Otherwise, the wand must be placed elsewhere along the window. Wall mounting clips are provided with the wand.

Retrofit Ordering Requirements:

- Rechargeable battery wand with clips (one per shade)
- Rechargeable battery charger (one or more per order, or as needed)
- Charge port mounting base (optional)

Please contact customer service for more information.



Battery Wand for Rechargeable Simplicity Retrofit



Rechargeable Battery Wand Concealed in Head rail. (Minimum width of 30" required) otherwise battery wand must be mounted externally.

Color Lux® Cellular Shades

SIMPLICITY RECHARGEABLE MOTORIZED CELLULAR SHADES

Simplicity Rechargeable Battery Life

Rechargeable batteries are included with the motor.

The average battery charge will last 6-12 months based on an average sized shade raised and lowered once per day. The life of the battery charge will vary based on the type of window covering selected, the size and weight of the window covering and the number of times the shade is operated on a daily basis.

The battery can be recharged up to 500 times. It takes approximately 5 hours to recharge the motor when fully depleted.

Ordering Information for Rechargeable Motorized Cellular Shades

Simplicity Motor Option

- Specify IB or OB mount and rail color.
- Specify remote and other accessories if needed.
- Specify one or more battery chargers.

Please Note:

- Not all motors run at the same rate of speed.
- Simplicity motors have a "Favorites" or "MY" position setting. If the homeowner wants to set several shades at the same intermediate position, follow instructions provided with installation manual.
- Simplicity Rechargeable Motorized Cellular Shades are programmed at the factory with the "up and down" limits. The shades are **UNLINKED** from the remote so they are not able to operate during shipping. Each shade should be installed **before** linking it to the remote.
- **REMEMBER: Order at least one charger if ordering rechargeable motors.**

Simplicity Motorized Shade Warranty

Please see pages 108-110 for complete Comfortex warranty information.

Battery Charger

8.4 Volt charger requires a standard power outlet to recharge the battery wand. Must specify charger when ordering a Simplicity Rechargeable Wand Shade. The charger plugs into the charger port. The charger is black and comes with a 156" wire. The dimensions are 1 7/8" wide x 3 1/4" length x 1 3/4" deep.



Simplicity Motor Hand Held Remotes 5 Channel Remote

The **5 Channel (5C) remote** can operate up to five shades simultaneously, individually or 5 groups. Simplicity Rechargeable Motorized Cellular Shades are programmed at the factory with the "up and down" limits. The shades are **UNLINKED** from the remote so they are not able to operate during shipping. Each shade should be installed **before** linking it to the remote.



Simplicity 5C remotes and holders are white or black in color. The remote comes with a holder which can be mounted to a wall for easy storage. The range of the remote is approximately 80 feet.

6 Channel Timer Remote

The **6 Channel (6C) timer remote** combines the functionality of a six channel hand-held control with the convenience of a programmable timer.

- The 6C timer remote allows for 18 different scheduled actions.
- Manual function disables the timer and the remote then operates as a held remote.



Simplicity 6C remotes and holders are white in color. The remote comes with a holder which can be mounted to a wall for easy storage. The range of the remote is approximately 80 feet.

Simplicity Rechargeable Motorized Cellular Shades are programmed at the factory with the "up and down" limits. The shades are **UNLINKED** from the remote so they are not able to operate during shipping. Each shade should be installed **before** linking it to the remote.

Simplicity Motor Hand Held Remotes Operation

Press the up or down button on the remote to raise or lower the shade to your desired position.

To reprogram channel assignments, please refer to the installation instructions and/or view the video at: comfortexdealers.com/products/motortechsupport.html.

The Simplicity remotes utilize one 3V battery. Batteries are included. Comfortex will warranty batteries for up to 3 months from date of purchase. Batteries are not covered by the warranty.

Color Lux® Cellular Shade Hardware Options SIMPLICITY SMART CONTROLLER



Simplicity Smart Controller Dimensions

- Width of controller: 2³/₈"
- Length of controller: 2¹⁵/₁₆"
- Height of controller: 1¹/₈"

Simplicity Smart Controller

- Works with Apple and Android devices
- FREE Downloadable Application
- Compatible with previously installed Simplicity Remote Control Shades
- Powered by NEO Smart Blinds App

Simplicity Smart Controller

The Simplicity Smart Controller is a small device that you install in your home that allows you to set automatic opening and closing times for all Simplicity motorized shades as well as the ability to control your motorized shades from a phone, tablet or PC from anywhere in world.

The Simplicity Smart Controller will work with any Comfortex remote motorized shade with Simplicity remote control motors purchased after 2012.

The Simplicity Smart Controller plugs into a standard electrical outlet and connects to WiFi and sends signals to your shades using the same radio frequencies as a normal remote control.

How Does The NEO Smart Blinds App Work?

The app uses WiFi or cellular data to send commands over the internet to the Simplicity Smart Controller.

Do I Need Any Other Equipment?

Yes, The location where your shades are installed must have WiFi in order for the Simplicity Smart Controller to work. Additionally, you must have a smartphone or tablet running Android or iOS (eg. iPhone, iPad, Samsung Galaxy S7) and have the NEO Smart Blinds app. installed.

Why Would I Want A Simplicity Smart Controller?

There are two main ways the Simplicity Smart Controller adds additional value to your motorized shades. First, once all of your shades have been added, you can use your smartphone as a single remote for all of your shades that will work anywhere you are regardless of distance from the shade. Secondly, the device allows you to set schedules so your motorized shades automatically open and close without needing to do anything on a day to day basis.

Do I Need To Buy More Than 1 Controller?

The normal use for the Simplicity Smart Controller is to plug it in out of the way and forget it. Since it has roughly the same range as a remote you will want enough devices to allow all shades to be operated without moving the controller. So depending on the layout of the home and location of the shade, you might want multiple devices to have convenient full home coverage.

How Far Is The Range Of A Controller?

You should see a range of approximately 150 ft. However this number might be less depending on the layout of your home. In general we recommend one per a floor of a normal sized home.

Can I Control My Shades From Multiple Devices?

Yes! You can download the NEO Smart Blinds App onto multiple devices, After installing the App. on a new device simply log in with the same email/password on each device and you will have access to control your shades.

Can It Be Used With Already Installed Shades?

Yes! Simply follow the directions in the NEO Smart Blinds app. to add a shade. At the pairing step you can put the shade in pairing mode using the primary remote control for it (or by accessing the button on the shades motor). Adding the shade to the NEO Smart Blinds App. will not affect the normal remote operation.

How Much Does The NEO Smart Blinds App Cost?

The app is a free download, However you must have at least one Simplicity Smart Controller (\$330) to serve as a bridge between the app and your shades.

Color Lux® Cellular Shades POWERTOUCH RECHARGEABLE MOTORIZED SHADES

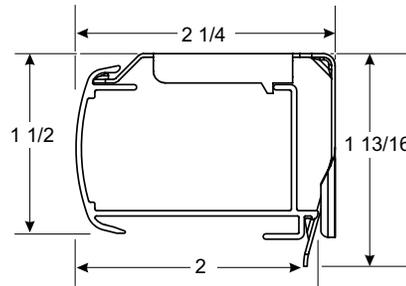

Simplicity Motorized Rail Dimensions

- Depth of rail: 2"
- Depth of rail and bracket: 2 1/4"
- Height of rail: 1 1/2"
- Height of bracket: 1 13/16"

Hardware Features	
Standard Hardware	<ul style="list-style-type: none"> Fabric Wrapped head and bottom rails. Head rail and Bottom rails will have frosted end caps with fabric inserts. Fabric used to cover the rails is the same fabric as the shade. The back of the rail will be white to the outside.
Simplicity Remote	Upper and lower limit stops pre-programmed, Intermediate stop "favorites" position can be set on site.
Upgrades	
Designer Metallic Upgrade	<ul style="list-style-type: none"> Smooth faced Designer Oil Rubbed Bronze head, middle, bottom rails and end caps Smooth faced Designer Brushed Nickel head, middle, bottom rails and end caps
Mounting Dimensions	
Simplicity Motorized Hardware System	
Minimum Shallow Mount	1/2"
Minimum Flush Inside Mount	2 1/4"
Minimum Outside Mount	7/8"
Minimum Side Mount	1 1/4"
Recommended Side Mounting Method	<ul style="list-style-type: none"> See page 20 for recommended mounting method for side mount shades Width limit for side mount brackets is 48"
Finished Dimensions	
Inside Mount	
	<ul style="list-style-type: none"> Fabric will measure ordered width less: 3/8" Head rail* will measure ordered width less: 3/16"
Outside Mount	
	<ul style="list-style-type: none"> Fabric will measure ordered width Head rail* will measure ordered width plus: 3/16"
Side Mount	
	<ul style="list-style-type: none"> Fabric will measure ordered width less: 7/8" Head rail* will measure ordered width less: 1 1/16"
Exact (End Cap to End Cap) Mount	
	<ul style="list-style-type: none"> Fabric will measure ordered width less: 3/16" Head rail* will measure ordered width
* Head rail measurements include endcaps. Width and length measurements may vary +/- 1/8"	

Color Lux® Cellular Shades

POWERTOUCH RECHARGEABLE MOTORIZED SHADES

PowerTouch™ Rechargeable Shades

Cellular Shades can be fabricated with the PowerTouch Rechargeable Push Button Control option. The PowerTouch Rechargeable option is an easy, cord free motorized operation for the budget savvy homeowner. PowerTouch Rechargeable uses Simplicity motors and components.

PowerTouch Rechargeable Shades Operation

Press the up or down button on the pendant to raise or lower the shading to your desired position. When the shading is fully lowered to the factory programmed lower limit.

No programming is required with PowerTouch™, all programming is set at the factory. Upper and lower limits easily can be adjusted in the field if desired. Please refer to the installation instructions at comfortexdealers.com. A "favorites" or intermediate stop position can be set once installed.

PowerTouch Rechargeable Surcharges

See page 3.

PowerTouch Appearance

- The PowerTouch wand and pendant is attached to the head rail when installed.
- The wand and pendant hangs down the front of the shades from the head rail. The wand does not touch the fabric.
- Pendant is 2½" long.
- The pendant does not need to be mounted to the wall to operate the shade.



PowerTouch Rechargeable Color Options

- Shades with Black or Oil Rubbed Bronze hardware will be built with black wand and pendants standard. All other colors will use white wand and pendants.



White



Black Shown with Plug-In Charger

PowerTouch Wand and Pendant Location

The standard location for the wand and pendant is on the right. Please specify location when ordering.

PowerTouch Rechargeable Wand Length

- The standard length of the wand will measure the indicated below unless otherwise specified.

Shading Length	Standard Wand Length
Up to 30"	1' (12")
>30" to 52"	2' (24")
>52" to 78"	3' (36")
>78" to 100"	4' (48")
>100" to 120"	5' (60")

Mounting Requirements for PowerTouch Rechargeable Shades

- No special installation hardware or wiring requirements are needed.

Battery Charger

8.4 Volt charger requires a standard power outlet to recharge the battery wand. Must specify charger when ordering a Simplicity Rechargeable Wand Shade. The charger plugs into the charger port. The charger is black and comes with a 156" wire. The dimensions are 1⅞" wide x 3¼" length x 1¾" deep.



PowerTouch Rechargeable Shades Warranty

Please see page 106 for complete warranty information.

Color Lux® Cellular Shade Hardware Options

SIMPLICITY WAVE RECHARGEABLE MOTORIZED CELLULAR SHADES

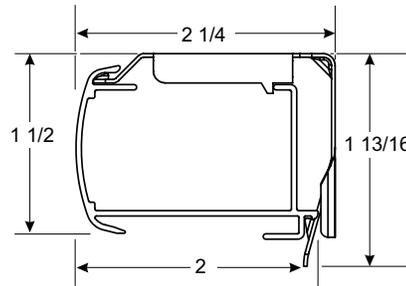

Simplicity Rechargeable Rail Dimensions

- Depth of rail: 2"
- Depth of rail and bracket: 2 1/4"
- Height of rail: 1 1/2"
- Height of bracket: 1 13/16"

Hardware Features	
Standard Hardware	<ul style="list-style-type: none"> • Fabric Wrapped head and bottom rails. Head rail and Bottom rails will have frosted end caps with fabric inserts. • Fabric used to cover the rails is the same fabric as the shade. The back of the rail will be white to the outside.
Telescoping Wand	Extends to 33" to reach shades mounted high. Wand retracts to 9" for easy storage.
Mounting Dimensions	
Mounting Dimensions	Simplicity Wave Rechargeable Motorization Hardware System
Minimum Shallow Mount	1/2"
Minimum Flush Inside Mount	2 1/4"
Minimum Outside Mount	7/8"
Minimum Side Mount	1 1/4"
Recommended Side Mounting Method	<ul style="list-style-type: none"> • See page 20 for recommended mounting method for side mount shades • Width limit for side mount brackets is 48"
Finished Dimensions	
Inside Mount	
	<ul style="list-style-type: none"> • Fabric will measure ordered width less: 3/8" • Head rail* will measure ordered width less: 3/16"
Outside Mount	
	<ul style="list-style-type: none"> • Fabric will measure ordered width • Head rail* will measure ordered width plus: 3/16"
Side Mount	
	<ul style="list-style-type: none"> • Fabric will measure ordered width less: 7/8" • Head rail* will measure ordered width less: 1 1/16"
Exact (End Cap to End Cap) Mount	
	<ul style="list-style-type: none"> • Fabric will measure ordered width less: 3/16" • Head rail* will measure ordered width
* Head rail measurements include endcaps. Width and length measurements may vary +/- 1/8"	

Color Lux® Cellular Shades SIMPLICITY WAVE MOTORIZED CELLULAR SHADES

Wave Rechargeable Simplicity Motor

The Simplicity Wave Motor features a battery powered motor utilizing a rechargeable battery hidden inside the shade head rail. Simplicity wave motors are compact and use a telescoping wand to raise or lower the shades.

Wave Rechargeable Motorized Lift Systems are not offered on sizes within the shaded area on the Standard Rectangular price grids.

Applications

- Standard Rectangular

EZ Level

Learn about the EZ Level feature on page 53.

Simplicity Wave Rechargeable Motorization Surcharges

The Simplicity Wave Rechargeable Motorized Lift System surcharge includes a rechargeable battery. A Wand is needed to operate the shades and a charger to charge the battery. Refer to pricing pages.

Ordering Information for Rechargeable Motorized Cellular Shades

Simplicity Motor Option

- Specify IB or OB mount and rail color.
- Specify wand and other accessories if needed.
- Specify one or more battery chargers.

Please Note:

- Not all motors run at the same rate of speed.
- Simplicity Wave Rechargeable Motorized Cellular Shades are programmed at the factory with the "up and down" limits.
- **REMEMBER: Order at least one charger if ordering rechargeable motors.**

SIMPLICITY RECHARGEABLE BATTERY WAND PRICING EXAMPLE:

Linen Weave	
Light Filtering 42" x 60" Shade:	\$350.00
Simplicity Wave Surcharge:	\$110.00
Charger for Wave Rechargeable:	\$27.00
Simplicity Wave Wand:	\$29.00
Total List Price:	\$751.00

Simplicity Wave Rechargeable Battery

The rechargeable battery is concealed in the head rail of the shade. A charger is required for the rechargeable battery. The rechargeable battery comes fully charged from the factory.

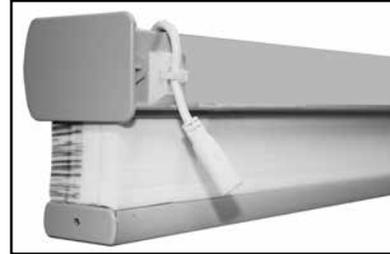

Charging Port on Back of Head rail.

Simplicity Rechargeable Battery Life

Rechargeable batteries are included with the motor.

The average battery charge will last 6-12 months based on an average sized shade raised and lowered once per day. The life of the battery charge will vary based on the type of window covering selected, the size and weight of the window covering and the number of times the shade is operated on a daily basis.

The battery can be recharged up to 500 times. It takes approximately 5 hours to recharge the motor when fully depleted.

Battery Charger

8.4 Volt charger requires a standard power outlet to recharge the battery wand. Must specify charger when ordering a Simplicity Rechargeable Wand Shade. The charger plugs into the charger port. The charger is black and comes with a 156" wire. The dimensions are 1 7/8" wide x 3 1/4" length x 1 3/4" deep.



Telescoping Wand

- Extends to 33" to reach shades mounted high.
- Wand retracts to 9" for easy storage.
- The wand is silver with white handle and white magic tip.
- Wall mount plate included for convenience.
- Wand is universal and will operate all Simplicity Wave shades



Simplicity Motorized Shade Warranty

Please see pages 108-110 for complete Comfortex warranty information.

The Ultimate Blackout Cellular Shade Head Rail Options

INSULATING SLUMBERSHADES



Standard Head Rail

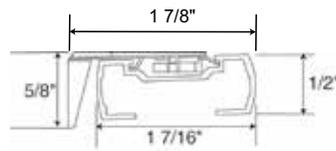

Deluxe Head Rail

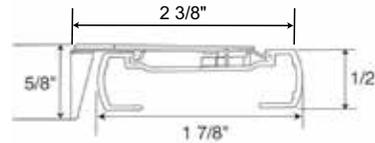

Cord Loop & Cordless Ultra Head Rail (Standard & Top Down-Bottom Up)

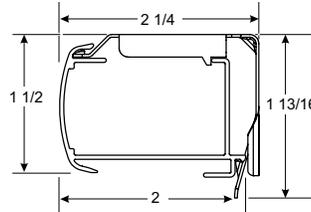

Standard Cord Lock Rail

- Depth of rail: 1 7/16"
- Depth of rail and bracket: 1 7/8"
- Height of rail: 1/2"
- Height of bracket: 5/8"

Deluxe Cord Lock Rail

- Depth of rail: 1 7/8"
- Depth of rail and bracket: 2 3/8"
- Height: 1/2"
- Height of bracket: 5/8"

Cord Loop & Cordless Ultra Rail

- Depth of rail: 2"
- Depth of rail and bracket: 2 1/4"
- Height of rail: 1 1/2"
- Height of bracket: 1 13/16"

Hardware Features		
Hardware colors for all Cellular fabrics	Fabric wrapped head, middle, bottom rails and end caps is standard. Back of rail is white to outside.	
Blackout Sidetrack Colors Available	White, Tan and Bronze	
Upgrades		
Designer Metallic Upgrade	• Oil Rubbed Bronze and Brushed Nickel head, middle, bottom rails and end caps.	
Mounting Dimensions (inside mount only)	Standard Head Rail	Deluxe Head Rail
Standard Cord Lock (Standard Retangular and Top Down-Bottom Up)		
Minimum Inside Mount	1 1/2"	1 1/2"
Minimum Flush Inside Mount	2"	2 3/8"
Cord Loop & Cordless Ultra (Standard Retangular and Top Down-Bottom Up)		
Minimum Inside Mount	1 5/8"	NA
Minimum Flush Inside Mount	2 1/4"	NA
Outside, shallow and side mounts are not available. The shade's light blocking ability is compromised by using any other mount than a fully flush mount application.		
Finished Dimensions		
Inside Mount		
	<ul style="list-style-type: none"> • Fabric will measure ordered width less: 7/8" • Head rail and bottom rail will measure ordered width less: 1 1/16" • Sidetrack length will measure ordered length less: 1/8" 	

The widest width of the window cannot exceed the narrowest width of the window by more than 1/4".

Precise width measurements are critical to proper performance of SlumberShade products. Make sure to measure to the nearest 1/16" and provide the NARROWEST width measurement along the length of the window. Be sure to measure the top, middle and bottom of the opening. It is very common for the width of a window to vary from top to bottom.

The Ultimate Blackout Cellular Shade Head Rail Options

INSULATING SLUMBERSHADE SHADES

Insulating SlumberShades Small Track Dimensions

Used with all fabrics standard size head rail.

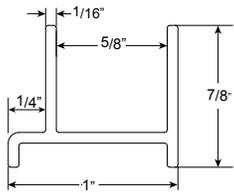

Small Track

- Width of track: 1"
- Height of track: 7/8"

Applications

- Standard Rectangular
- Top Down - Bottom Up
- Cordless and Cordless Top Down - Bottom Up
- Cord Loop and Top Down - Bottom Up

SlumberShades are for inside mount applications only.

Insulating SlumberShade Fabric

Light Filtering fabrics are available as SlumberShades, however the best light control is achieved by using a blackout cellular fabric.

Ordering Information for Insulating SlumberShades

SlumberShades are for inside mount applications only.

Precise width measurements are critical to proper performance of SlumberShade products. Make sure to measure to the nearest 1/16" and provide the **NARROWEST** width measurement along the length of the window. Be sure to measure the top, middle and bottom of the opening. It is very common for the width of a window to vary from top to bottom. The widest width of the window cannot exceed the narrowest width of the window by more than 1/4".

If you have questions about ordering SlumberShades, contact Comfortex Technical Services at 800-843-4151.

Accessories

- 6' Expandable Pole: \$37.00
- 12' Expandable Pole: \$46.00



Specially designed pole end fits into the handle on the Cordless Ultra bottom rail and allows for easy operation.

Insulating SlumberShades Features

Use SlumberShades to provide the darkest sleeping environment by sealing out the highest percentage of light.

Energy Saving Blackout Sidetracks

Energy saving blackout sidetracks are made from a durable window grade PVC. The blackout sidetracks seal off the light gap between the blackout cellular shade and the window. The blackout sidetracks feature a black interior lining to absorb light and prevent it from entering the room.



Insulating SlumberShades Large Track Dimensions

Used with all fabrics that utilize the deluxe sized head rail.

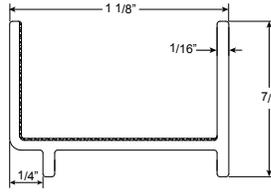

Large Track

- Width of track: 1 1/8"
- Height of track: 7/8"

SlumberShades are easy to install, and feature removable sidetracks that are attached to the window frame with magnets. The sidetracks can be removed for window cleaning. The UV stable, window grade PVC sidetracks are available in white, tan and bronze to match your existing trim.

Please Note: When properly installed, SlumberShades block 99% of all visible light. In certain installations with intense sunlight, a very small amount of light may reflect around the edges of the honeycomb fabric along each side of the shade. This is a normal attribute of the SlumberShade system.

Insulating SlumberShade End Caps

The specially designed notched bottom rail end caps fit over the blackout sidetracks and allow for smooth movement when raising and lowering the shade.

Head and Bottom Rail Seals

To ensure a perfectly dark sleeping environment, additional fuzzy seals are supplied to be placed along the shade's bottom rail and between the head rail and the window frame if needed. These barriers provide a complete light stop all the way around the window to keep all exterior light out. Also, these additional seals provide a very effective barrier against heat loss along your windows.

Magnets and fuzzy bar are standard on Cordless and Cordless Top Down-Bottom Up Shades to ensure closure between the bottom rail and window sill.

Energy Efficiency

Independent testing has shown SlumberShades provide an R-value greater than 7.0* when installed over a double paned vinyl window. The testing also indicates that the R-value of a SlumberShade is 2.5 to 3 times higher than that of the same shade without sidetracks. The insulating cellular fabric, sidetracks, and fuzzy seal all ensure that the SlumberShades provides superior energy efficiency.

* Independent testing provided by Consortium for Advanced Residential Buildings (CARB), a U.S. Department of Energy Building America research team. Learn more at comfortexdealers.com.

EZ Level

Learn about the EZ Level feature on page 122.

Color Lux® Cellular Specialty Shades STARBURST ARCHES

Stationary Starburst

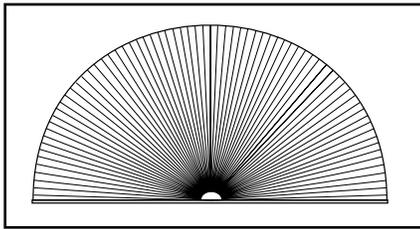

Figure A

Movable Starburst

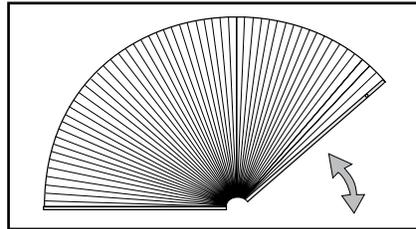

Figure B

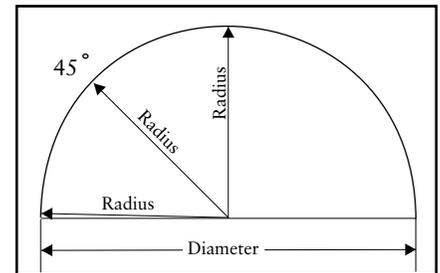

Figure C

Hardware Features See Page 17 for Rail Dimensions	
Standard Hardware	Fabric wrapped rail is standard. The fabric will be spliced in the center of the rail. A decorative rosette is supplied to conceal the splice.
Designer Metallic	<ul style="list-style-type: none"> • Oil Rubbed Bronze rails with bronze colored end caps. • Brushed Nickel rails and end caps.
Mounting Dimensions	
Minimum Shallow Mount	3/4"
Minimum Flush Inside Mount	2 3/8"
Recommended Side Mounting Method	
	<ul style="list-style-type: none"> • See figure B, pg 20 for recommended mounting method for side mount shades • Width limit for side mount brackets is 48"
Finished Dimensions	
Inside and Side Mount	
<ul style="list-style-type: none"> • Fabric will measure ordered width less: 3/8" • Head rail* will measure ordered width less: 3/16" 	<ul style="list-style-type: none"> * Head rail measurements include endcaps. Width and length measurements may vary +/- 1/8"

Applications

- Stationary Fan Style Arch
 - Movable Fan Style Arch
- Movable Starburst Arch shades are for inside and shallow mount applications only.

Stationary Starburst Features (Figure A)

- **All non-perfect Stationary Starburst arches require a template made from brown craft paper.** Comfortex offers template kits. Please contact Customer Service to order. Stock number: 751000, See page 107
- A perfect arch is twice as wide as it is high.
- Stationary Starburst shades which are not perfect half circles must have a height that equals half the width +/- 5".
- Price according to the largest radius measurement. If the height is greater than the width, take height X 2 and use that number to determine pricing.
- When ordering arches as perfect half-circles make sure the radius of the arch remains constant to ensure a proper fit. (See Figure C)

Movable Starburst Features (Figure B)

- Starburst Movable archtop shades are cut to perfect half circles only and do not require a template. The height must be exactly 1/2 the diameter.
- A perfect arch is twice as wide as it is high.
- When ordering arches as perfect half circles make sure the radius of the arch remains constant to ensure a proper fit. (See Figure C)
- The hinge gap (gap between the two rails) is not centered in the window. The moving rail is always smaller than the stationary rail to provide proper movement within the window.

Accessories

- 6' Expandable Pole: \$37.00
- 12' Expandable Pole: \$46.00

Specially designed pole end fits into the handle on movable Starburst Shades for easy operation.



Color Lux® Cellular Specialty Shades

QUARTER ROUNDS

Movable Quarter Round

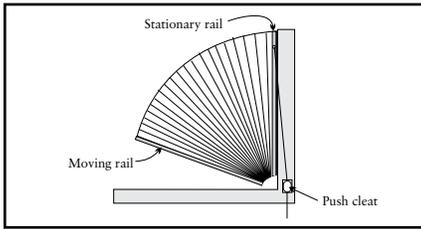

Figure A

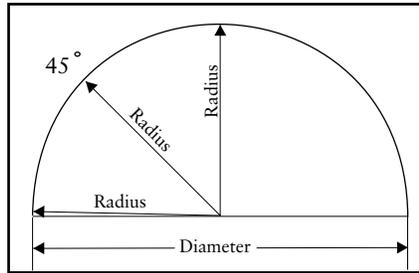

Figure B

Stationary Quarter Round

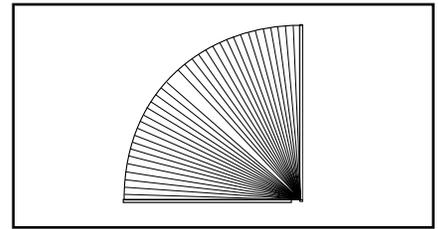

Figure C

Hardware Features | See Page 17 for Rail Dimensions

Hardware colors for all Cellular and Pleated fabrics	Fabric wrapped rails with white cord and tassel. Fabric used is same fabric as the shade. Back of rail is white to outside.
--	---

Upgrades

Designer Metallic Upgrade	<ul style="list-style-type: none"> • Oil Rubbed Bronze rails and endcaps, bronze colored tassel and white cord. • Brushed Nickel rails and end caps with coordinating tassel and white cord.
---------------------------	--

Mounting Dimensions

	Standard Rail	Deluxe Rail
Minimum Shallow Mount	3/4"	3/4"
Minimum Flush Inside Mount	2"	2 3/8"
Minimum Outside Mount	3/4"	3/4"
Minimum Side Mount	1 1/8"	1 3/8"
Recommended Side Mounting Method	• See page 20 figure F for recommended mounting method for side mount shades	

Finished Dimensions

Inside and Side Mount

- Fabric will measure ordered width less: 3/8"
- Head rail* will measure ordered width less: 3/16"

Outside Mount

- Fabric will measure ordered width
- Head rail* will measure ordered width plus: 3/16"

Exact (End Cap to End Cap) Mount

- Fabric will measure ordered width less: 3/16"
- Head rail* will measure ordered width

* Head rail measurements include endcaps.
Width and length measurements may vary +/- 1/8"

Applications

- Stationary Fan Style Quarter Round
- Movable Fan Style Quarter Round

Accessories

- 6' Expandable Pole: \$37.00
- 12' Expandable Pole: \$46.00



Ordering Information for Quarter Rounds Shades

- Specify IB or OB mount and rail color.
- Include a template if the shade is a non-perfect quarter round.

Specially designed pole end fits into the handle on movable Quarter Round Shades for easy operation.

Color Lux® Cellular Specialty Shades QUARTER ROUNDS

Quarter Rounds Features (Figure A)

- **All Quarter Round Shades which are not perfect quarter circles require a template.** Price according to the largest radius measurement.
- See page 107 for template instructions.
- **All templates should be made from brown craft paper.** Comfortex offers template kits. Please contact Customer Service to order. Stock number: 751000
- The horizontal (moving) rail of a Movable Quarter Round shade **must be smaller** than the vertical (stationary) rail to allow clearance for the moving rail. The shade will stack in the vertical position.
- When ordering arches as perfect quarter circles, make sure the radius of the arch remains constant to ensure a proper fit. (See Figure B, page 38)



Color Lux® Cellular Specialty Shades SUNSET ARCHES

Movable Sunset

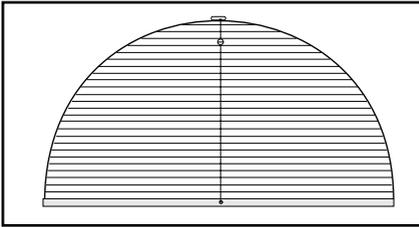

Figure A

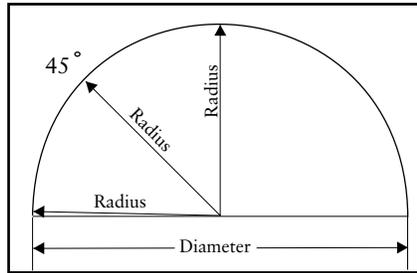

Figure B

Two-String Hanging Method

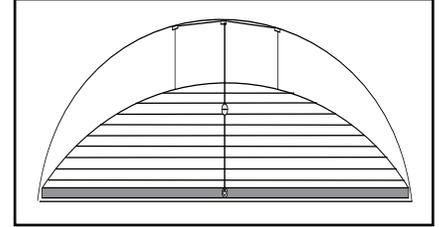

Figure C

Hardware Features | See Page 17 for Rail Dimensions

Fabric Wrapped	Fabric used is same fabric as the shade. Back of rail is white to outside. Clear frosted end caps, white cord and silver tassel
Designer Metallic	<ul style="list-style-type: none"> • Oil Rubbed Bronze rails with bronze colored end caps and white cord. • Brushed Nickel rails and end caps with white cord.

Mounting Dimensions	Standard Cord Lock Rail
Minimum Shallow Mount	3/4"
Minimum Flush Inside Mount	2 3/8"
Minimum Outside Mount	3/4" Outside mounting requires the use of an extension "L" bracket for the mounting of the top block.
Minimum Side Mount	1 1/8"
Recommended Side Mounting Method	<ul style="list-style-type: none"> • See page 20, figure A for recommended mounting method for side mount shades • Width limit for side mount brackets is 48"

Finished Dimensions

Inside and Side Mount	
	<ul style="list-style-type: none"> • Fabric will measure ordered width less: 3/8" • Head rail* will measure ordered width less: 3/16"
Outside Mount	
	<ul style="list-style-type: none"> • Fabric will measure ordered width • Head rail* will measure ordered width plus: 3/16"
Exact (End Cap to End Cap) Mount	
	<ul style="list-style-type: none"> • Fabric will measure ordered width less: 3/16" • Head rail* will measure ordered width

* Head rail measurements include endcaps.
Width and length measurements may vary +/- 1/8"

Applications

- Movable Arch

Ordering Information for Sunset Shades

- Specify IB or OB mount and rail color.
- Include a template if the shade is a non-perfect arch.

Accessories

- 6' Expandable Pole: \$37.00
- 12' Expandable Pole: \$46.00



Specially designed pole end fits into the ball on Sunset Shades for easy operation.

Color Lux® Cellular Specialty Shades SUNSET ARCHES

Sunset Features and Ordering Notes (Figure A)

- Sunset shades have horizontal pleats that stack at the bottom, on a stationary sill rail. Sunset shades are operated by a continuous cord that runs through a top mount guide block and back down through the stationary rail. A moving metal ball attached to the cord is used to raise and lower the shade. (See Figure E).
- **All Sunset arches which are not perfect half circles require a template.** A perfect arch is twice as wide as it is high. See page 107 for template instructions.
- **All templates should be made from brown craft paper.** Comfortex offers template kits. Please contact Customer Service to order. Stock number: 751000
- Sunset shades which are not perfect half circles must have a height which is equal to or greater than 25% of the width.
- When ordering Sunset shades that are perfect half circles, make sure the radius of the arch remains constant to ensure a proper fit. (See Figure B).
- **Stringing Method:** Depending on the curvature of a particular arch, it may be necessary to use the two string method (See Figure C) to ensure proper fit and operation of your Sunset shade. Comfortex will determine the best stringing method after examination of the template.
- **Arch Styles:** Sunset arches are available in a variety of styles including: palladium, eyebrow and bullet shaped arches. (See Figure D).

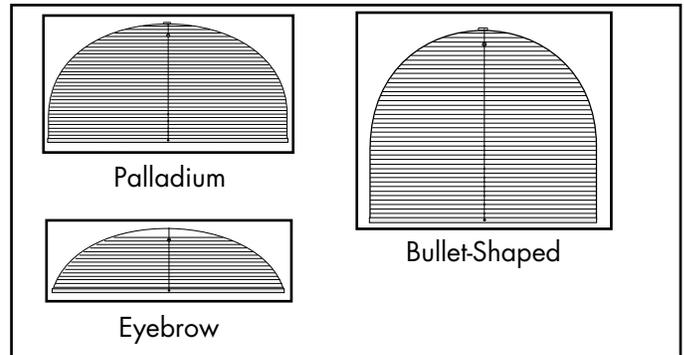

Figure D

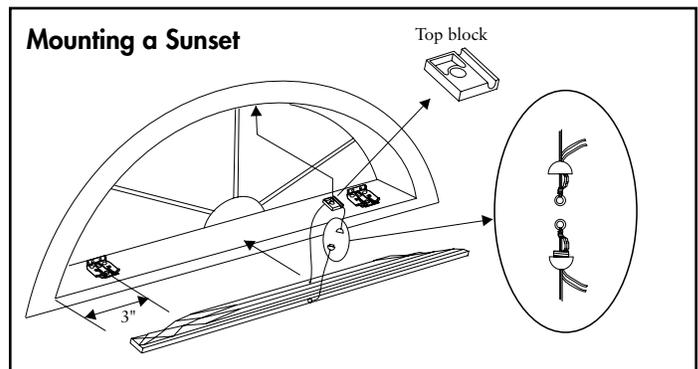

Figure E

Recommended Mounting Method for Side Mounting Shades

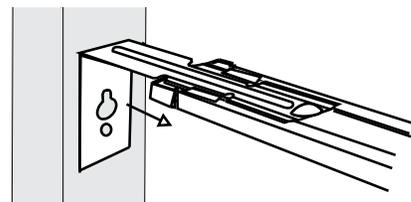
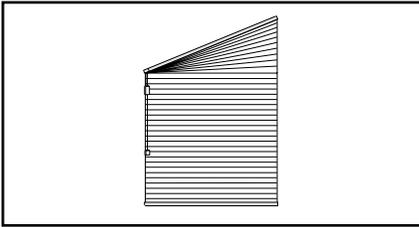

Figure F

Refer to the installation instructions on Comfortexdealers.com or the OnDemand Mobile Library for further details on side mounting shades.

Color Lux® Cellular Specialty Shades TRAPEZOIDS AND OCTAGONS

Movable Trapezoids



Movable Octagons

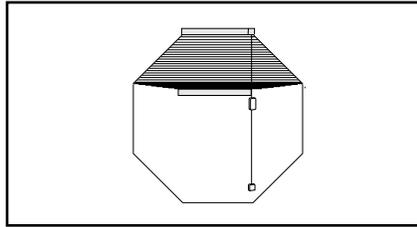

Hardware Features | See Page 17 for Rail Dimensions

Fabric Wrapped	Fabric used is same fabric as the shade. Back of rail is white to outside. Frosted clear end caps with white cord and tassel
Designer Metallic	<ul style="list-style-type: none"> • Oil Rubbed Bronze head and bottom rails with bronze colored tassel, end caps and white cord. • Brushed Nickel head and bottom rails and end caps with coordinating tassel and white cord.

Mounting Dimensions

Standard Cord Lock Rail

Minimum Shallow Mount	3/4"
Minimum Flush Inside Mount	2"
Minimum Outside Mount	3/4"
Minimum Side Mount	1 1/8"
Recommended Side Mounting Method	<ul style="list-style-type: none"> • See page 43 for recommended mounting method for side mount shades • Width limit for side mount brackets is 48"

Finished Dimensions

Inside and Side Mount

- Fabric will measure ordered width less: 3/8"
- Head rail* will measure ordered width less: 3/16"

Outside Mount

- Fabric will measure ordered width
- Head rail* will measure ordered width plus: 3/16"

Exact (End Cap to End Cap) Mount

- Fabric will measure ordered width less: 3/16"
- Head rail* will measure ordered width

* Head rail measurements include endcaps.
Width and length measurements may vary +/- 1/8"

Applications

- Movable Trapezoids
- Movable Octagons

Ordering Information for Trapezoid Shades

- Specify IB or OB mount and rail color.
- **Trapezoid orders must be faxed or emailed in with a diagram. Please provide measurements for all four sides when ordering. No template is required.**

Ordering Information for Octagon Shades

- Specify IB or OB mount and rail color.
- **The width, length and one side are required measurements when ordering.**

Color Lux® Cellular Specialty Shades TRAPEZOIDS AND OCTAGONS

Trapezoids (Figure A)

- Trapezoid orders must be faxed in with a diagram. Please provide measurements for all four sides when ordering. No template is required.
- The maximum slope of the top rail is 30 degrees from horizontal. Slope is the angle between slope and a horizontal line. The slope angle must be measured with a protractor.
- Sides of trapezoid must be parallel.
- Sill must be level for proper installation and operation of a trapezoid shade.
- Operating cord must be placed on the short side.
- See Figures B and C for trapezoid shade operation.

Octagons

- The width, length and one side are required measurements when ordering.
- Octagon shades raise only to the point where the top angle begins. (See Figure D)
- See Figure F on page 43 for recommend mounting method for side mount shades.
- Width limit for side mount brackets is 48".

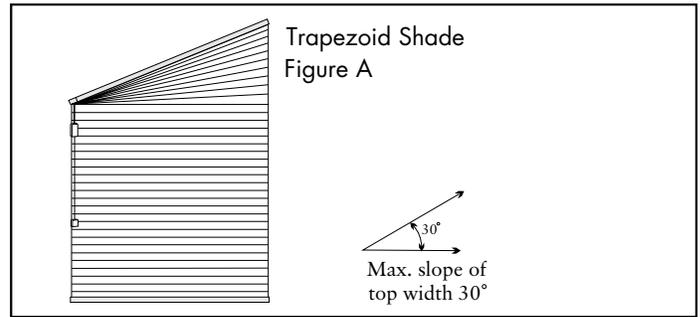

Trapezoid Shade Operation

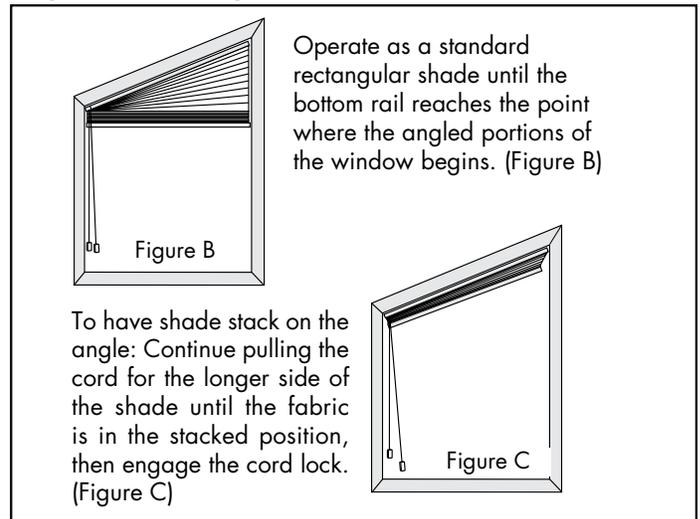

Octagon Operation

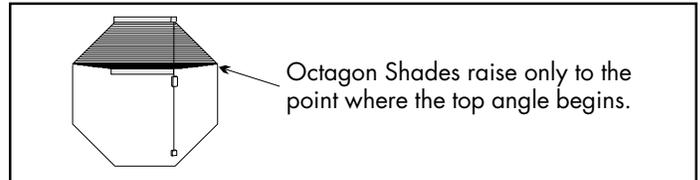
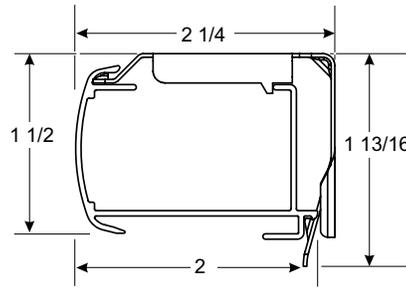

Figure D



Color Lux® Cellular Specialty Shades
MEZZO MOTORIZED SKYLIGHT SHADES



Simplicity Motorized Rail Dimensions

- Depth of rail: 2"
- Depth of rail and bracket: 2 1/4"
- Height of rail: 1 1/2"
- Height of bracket: 1 13/16"

Hardware Features

Hardware colors	White aluminum head, bottom and side rails
Simplicity Remotes	Upper and lower limit stops pre-programmed, Intermediate stop "favorites" position can be set on site, 5 channel or 6 channel timer option

Mounting Dimensions

Mounting Dimensions	Mezzo Motorized Skylight Shades
Minimum Flush Inside Mount	2 1/2"
	<ul style="list-style-type: none"> • Should not be more than 1/2" out of square to perform as intended • The widest width of the window cannot exceed the narrowest width of the window by more than 3/8". • The shade must be mounted with the fabric stack at the bottom or the lowest point of the window
	See page 475 for Solar Panel Mounting information.

Finished Dimensions

Inside Mount

	<ul style="list-style-type: none"> • Fabric will measure ordered width less: 1 1/4" • Head rail* will measure ordered width less: 3/16"
* Head rail measurements include endcaps. Width and length measurements may vary +/- 1/8"	

MOTORIZATION - HARDWARE UPGRADE SURCHARGES AND ACCESSORIES All standard discounts apply to motorized shades		ADD
	Simplicity - Motor and Battery Wand	\$334
	Simplicity 5 Channel Remote	\$40
	Simplicity 6 Channel Remote with Timer	\$65
	48" Extension Wire:	\$18
	DC Power Supply	\$63
	Simplicity Smart Controller (NEO)	\$330
	Solar Panel Recharge Kit : Includes Solar Panel with brackets, rechargeable battery wand with clips and Y cable	\$173
	Plug In Charger: for rechargeable battery wand in Solar Recharge Kit	\$54

Applications

- Horizontal, Angled and Vertical motorized skylight shades.
- Mezzo Motorized Skylight Shades are for inside mount applications only.

Ordering Information for Mezzo Motorized Skylight Shades

- Specify inside mount dimensions.
- Specify fabric color and style.
- Specify remote and other accessories if needed.

Color Lux® Cellular Specialty Shades MEZZO MOTORIZED SKYLIGHT SHADES

Solar Panel Recharge Option

Instead of disposable alkaline or lithium batteries, use a battery wand with rechargeable batteries to harness the power of the sun.

A Simplicity solar panel converts the sun's light into electrical energy providing a constant trickle charge for the rechargeable batteries.

The solar panel measures 21" x 2¾" x ½".

The rechargeable battery wand measures 22" long.



Dimensions of panel
21" x 2¾" x ½"



Side View of Panel

Solar Recharge Optimum Application

- Full direct sunlight (minimum 4-6 hours per day) to maintain full charge. Based on one operation cycle per day (one open, one close).
- Solar panel will charge batteries even without direct sunlight. Ambient light will charge the batteries but at a slower rate.
- Excessive duration of cloudy weather will impact the rate of charge.
- 12 Volt DC power supply is available if you find that your application does not provide sufficient solar energy to maintain a full charge.
- 12 Volt DC power supply requires a standard power outlet to power the motor. The transformer is an alternative to a battery wand. Each transformer can power a single shade with a Simplicity motor. The DC power supply is white and comes with a 80" wire. The dimensions are 1⅞" wide x 3¼" long x 1¼" deep.



Solar Panel Mounting

The solar panel can be mounted to the window casing with supplied brackets or can be mounted directly to the glass using supplied special double stick tape (Figures A-B).

- **Inside Mount - Solar Panel Mounted to Glass:** Minimum depth for flush inside mount when mounting the solar panel directly to glass: 3"
- **Inside Mount - Solar Panel Mounted to Glass with battery wand:** 4"
- **Inside Mount - Solar Panel Mounted with Brackets:** Minimum depth for flush inside mount when mounting the solar panel with the supplied swivel brackets: 4¼"
- **Inside Mount - Solar Panel Mounted with Brackets with battery wand:** 5¼"
- **The shade must be mounted with the fabric stack at the bottom or the lowest point in the window.**

Solar Panel Location Requirements

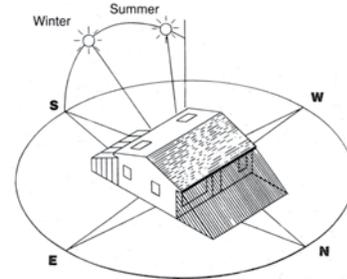

For Locations North of Washington, DC (39° Latitude)



For Locations South of Washington, DC (39° Latitude)



- Assumptions:** 1) Window area free from shadows 9 AM to 3 PM.
2) Glazing is double pane, clear.

Excessive shading or tinted glass will impact the solar charging capability of the system.

- Indicates orientations which may require periodic manual recharge with Plug In Charger.
- Indicates orientations which are optimum for solar recharge (wireless systems).

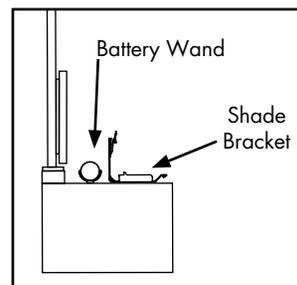

Figure A
Shade with Solar Panel Mounted to Glass

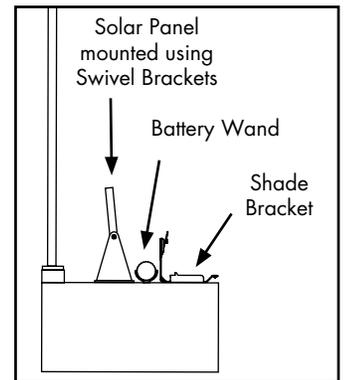
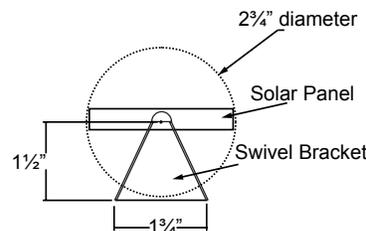

Figure B
Shade with Solar Panel Mounted using Supplied Swivel Brackets



Color Lux® Cellular Specialty Shades MEZZO MOTORIZED SKYLIGHT SHADES

COLOR LUX® CELLULAR SHADES

Simplicity Hand Held Remotes

The 5 Channel remote can operate up to five shades simultaneously, individually or in groups. **WHEN ORDERING PLEASE SPECIFY WHICH CHANNELS ARE ASSIGNED TO EACH SHADE OR GROUP OF SHADES.**

For example; program line 1 to channel 1, line 2 and 3 to channel 2, etc. If no channels are assigned at time of order, all shades will be programmed to Channel 1. **To reprogram channel assignments, please refer to the installation instructions and/or view the video at comfortexdealers.com/products/motortechsupport.html.**



A **6 Channel (6C) timer remote** is also available. See page 31 for more information

Simplicity remotes and holders are black in color. The remote comes with a holder which can be mounted to a wall for easy storage. The range of the remote is approximately 80 feet.

The Simplicity remote utilizes one 3V battery (CR2032). Batteries are included. Comfortex will warranty batteries for up to 3 months from date of purchase. Batteries are not covered by the warranty.

Simplicity Battery Wand

Batteries or a DC plug-in transformer are needed to operate Simplicity motors. The battery wand is wall or ceiling mounted utilizing white battery wand clips. The 12 volt battery wand measures 17¼", and comes with eight alkaline batteries, and is white in color. The rechargeable battery wand as part of the Solar Recharge kit measures 22" long.

Important Simplicity Motorized Shades Operating and Installation Information

- Simplicity Motorized Shades installed into windows with metal casings may have a reduced radio frequency range, or may not operate at all, depending on the application.
- Do not let the antenna on the motor touch any metal objects. This may interfere with signals from the remote control.
- Make sure to leave the top of the shade head rail open (motor exposed), do not cover; especially with metal materials. This could result in a reduced radio frequency range for the remote control or the shade may not operate at all, depending on the application.



Color Lux® Cellular Specialty Shades
FRENCH DOOR DÉCOR



Deluxe Head Rail

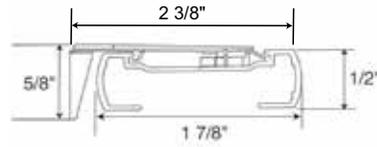

Deluxe Rail

- Depth of rail: 1 7/8"
- Depth of rail and bracket: 2 3/8"
- Height: 1/2"
- Height of bracket: 5/8"

Hardware Features	
Fabric Wrapped Upgrade	Fabric used is same fabric as the shade. Back of rail is white to outside. Frosted clear end caps with fabric insert.
Designer Metallic Upgrade	<ul style="list-style-type: none"> • Oil Rubbed Bronze head, middle, bottom rails and end caps. • Brushed Nickel head, middle, bottom rails and end caps.

Mounting Dimensions	French Door Decor Hardware System
Minimum Shallow Mount	3/4"
Minimum Flush Inside Mount	2 3/8"
Minimum Outside Mount	3/4"
Minimum Side Mount	1 3/8"
Recommended Side Mounting Method	<ul style="list-style-type: none"> • See page 43 for recommended mounting method for side mount shades • Width limit for side mount brackets is 48"

Finished Dimensions	
Inside and Side Mount	
	<ul style="list-style-type: none"> • Fabric will measure ordered width less: 3/8" • Head rail* will measure ordered width less: 3/16"
Outside Mount	
	<ul style="list-style-type: none"> • Fabric will measure ordered width • Head rail* will measure ordered width plus: 3/16"
Exact (End Cap to End Cap) Mount	
	<ul style="list-style-type: none"> • Fabric will measure ordered width less: 3/16" • Head rail* will measure ordered width

* Head rail measurements include endcaps.
 Width and length measurements may vary +/- 1/8"

Color Lux® Cellular Specialty Shades DOOR DECOR

Applications

- Stationary Door Décor
- Movable Door Décor
- Top Down - Bottom Up Door Décor
- Cover French doors, transoms, and side lights.

French Door Décor Hardware Features

- Features two non-moving rails which are mounted in the window or door. A tension control system enables the movable rail to be easily moved with the touch of a finger. The only visible cords are the ones that hold the movable middle rail in place.
- The widest width of the window cannot exceed the narrowest width of the window by more than $\frac{3}{8}$ ".

Stationary Non-Movable French Door Décor Shades

- Top and bottom rails are mounted to the window and are stationary.

Movable French Door Décor Shades

- Top and bottom rails are mounted to the window, one middle movable rail raises from the bottom.

Top Down - Bottom Up Option

- Top and bottom rails are mounted to the window, two movable rails allow the shade to lower from the top and raise from the bottom.
- The non-movable top and bottom rails are attached to the window or door.
- Ideal for entry ways with narrow windows next to doors and other narrow windows that are easily accessible.

Ordering Information for French Door Décor

- Specify IB or OB mount and rail color.
 - Specify stationary, movable or Top Down - Bottom Up.
- You may want to specify hold down brackets if mounting on a door.

Accessories

- 6' Expandable Pole: \$37.00
- 12' Expandable Pole: \$46.00

Specially designed pole end allows for easy operation of French Door Décor Shades.



French Door Decor Cellular Shades Hardware

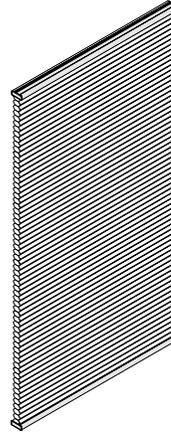

Stationary Non-Movable

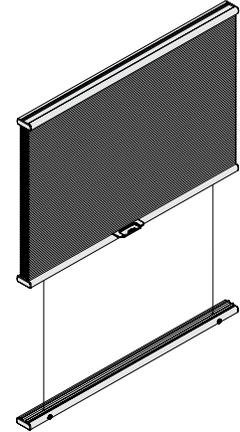

Shown open with movable rail option

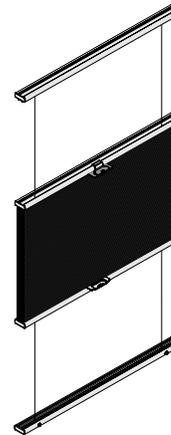

Shown open with Top Down - Bottom Up Option

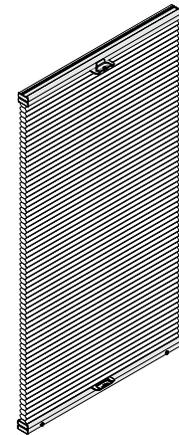

Shown closed with Top Down - Bottom Up Option

Color Lux® Cellular Specialty Shades DAY-NIGHT SHADES



Deluxe Head Rail

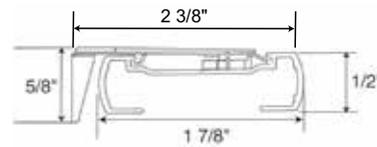

Deluxe Rail

- Depth of rail: 1 7/8"
- Depth of rail and bracket: 2 3/8"
- Height: 1/2"
- Height of bracket: 5/8"

Hardware Features

Fabric Wrapped Upgrade	Fabric used is same fabric as the shade. Back of rail is white to outside. Frosted clear end caps with fabric insert.
Designer Metallic Upgrade	<ul style="list-style-type: none"> • Oil Rubbed Bronze head and bottom rails with bronze colored tassel, end caps and white cord. • Brushed Nickel head and bottom rails and end caps with coordinating tassel and white cord.

Mounting Dimensions	Standard Cord Lock Rail
Minimum Shallow Mount	3/4"
Minimum Flush Inside Mount	2 3/8"
Minimum Outside Mount	3/4"
Minimum Side Mount	1 1/8"
Recommended Side Mounting Method	<ul style="list-style-type: none"> • See page 43 for recommended mounting method for side mount shades • Width limit for side mount brackets is 48"

Finished Dimensions

Inside and Side Mount	
	<ul style="list-style-type: none"> • Fabric will measure ordered width less: 3/8" • Head rail* will measure ordered width less: 3/16"
Outside Mount	
	<ul style="list-style-type: none"> • Fabric will measure ordered width • Head rail* will measure ordered width plus: 3/16"
Exact (End Cap to End Cap) Mount	
	<ul style="list-style-type: none"> • Fabric will measure ordered width less: 3/16" • Head rail* will measure ordered width
* Head rail measurements include endcaps. Width and length measurements may vary +/- 1/8"	

Applications

- Standard Rectangular with cellular fabrics only.

Day - Night Shade Specifications

Refer to the appropriate fabric sections for proper pricing.

Fabrics

- Privada fabrics cannot be used to build a Day-Night Shade. Some fabrics (i.e. Symphony Blackout) can be used exclusively only as a bottom panel only.

Color Lux® Cellular Specialty Shades DAY-NIGHT SHADES

Rail Colors and Cord Colors

- **Color Coordinated Rail Shades:** The top rail and middle rail will coordinate with top fabric and bottom rail will coordinate with the bottom fabric. The cord and tassel will be white. Not available with Color Lux Shades.
- **Designer Metallic Hardware Shades:** All rails, end caps and tassels will be the selected metallic color. Cords will be white.
- **Fabric Wrapped Rail Shades:** The top rail and middle rail will coordinate with top fabric and bottom rail will coordinate with the bottom fabric. The cord and tassel will be white. End caps and cord lock will be color coordinated.

Ordering Information for Day - Night Shade

- Specify fabrics, top and bottom panels.
- Specify IB or OB mount and rail color.

TOP FABRIC

CELLULAR	Width		Length	
	Min	Max	Min	Max
NEW Verona	12"	72"	18"	96"
NEW Boutique	12"	72"	18"	96"
Baritone (all)*	12"	72"	18"	96"
Debut ½" Double Cell Light Filtering	12"	72"	18"	96"
Debut ¾" Single Cell Light Filtering	12"	72"	18"	96"
Color Lux Linen Weave Light Filtering*	12"	72"	18"	96"
Color Lux Linen Weave Room Darkening*	NA	NA	NA	NA
Linen Weave Light Filtering*	12"	72"	18"	96"
Linen Weave Room Darkening*	NA	NA	NA	NA
Premiere ¾" Single Cell Blackout	NA	NA	NA	NA
Premiere ¾" Single Cell Light Filtering	12"	72"	18"	96"

BOTTOM FABRIC

Width		Length	
Min	Max	Min	Max
12"	72"	18"	96"
12"	72"	18"	96"
12"	72"	18"	96"
12"	72"	18"	96"
12"	72"	18"	96"
12"	72"	18"	96"
12"	72"	18"	96"
12"	72"	18"	96"
12"	72"	18"	96"
12"	72"	18"	96"

* Day-Night Shades can only be built in conjunction with other ¾" cellular fabrics. All Debut includes print patterns: Strie, Terazzo, Angel Hair, Strat, Florance, Blossom, Country Woven and Homespun.

Color Lux® Cellular Shades HIGHLIGHTS CORNICE VALANCE



Highlights Cornice Valances

Highlight any element of your home décor with the Highlights Cornice Valance upgrade.

This tailored, fabric wrapped 6-inch valance, available with seven returns sized from 1 ½" to 6", mounts over any product, either inside or outside the frame. The NEW KEYSTONE option now allows for all Color Lux Roller fabrics to cover widths up to 216".

Highlights Valance without a keystone can be added to your cellular shade order or as a stand alone product. Highlights Valance orders with a keystone are a stand alone product only.

See 7 for more information and pricing.

EZ Level on Comfortex Cellular Shades

EZ Level makes quick work of leveling without cords to cut or tuck into a rail. No special tools needed – just use a nickel, quarter or penny to adjust plug on the bottom rail.

EZ Level is standard on all Cellular and Pleated Shades with the following hardware systems:

- Standard and Deluxe Cord Lock
- Cordless Ultra
- Cord Loop
- SlumberShades
- Simplicity Motorized Systems

EZ Level is not available with Lift & Lock Cordless.

How does EZ Level work?

- Slightly raise the bottom rail you want to level.
- Insert a coin or flat head screwdriver into the adjustment screw and turn it.
- Turn the adjustment screw clockwise or counter clockwise to make slight adjustments up or down.



- One quarter turn of the adjustment screw will move the bottom rail up or down ¼".
- Lower the rail to check the level and make further adjustments if necessary.

Color Lux® Roller Shades Introducing Color Lux Linen and Solar Screen 5



Now Featuring Skyline Roller Hardware

COLOR LUX
Designer Cellular & Roller Shades

Color Lux® Roller Shade Hardware Options

	Key Features	Control Options	Hardware Color Options	Hardware Size (Depth x Height)	Roll Style
Standard Roller 	<ul style="list-style-type: none"> Sturdy aluminum tube for durability Perfect under top treatments Cord loop length does not change while operating shade 	<ul style="list-style-type: none"> Cord Loop Motorization 	<ul style="list-style-type: none"> White or Black Clutch White, Black, Steel or Bronze bead chain 	Standard 1½" x 1½" 1½" x 2" Oversized 2" x 1½" 2" x 2½"	Standard Reverse
Designer Cassette with Fabric Insert Strip 	<ul style="list-style-type: none"> Cassette head rail features a matching fabric insert Hides the roller shade mechanism for a tailored appearance 	<ul style="list-style-type: none"> Cord Loop Cordless Motorization 	<ul style="list-style-type: none"> White Ivory (New) Black Satin Nickel (New) Oil Rubbed Bronze All with fabric insert strip	3¾" x 2⅞"	Standard
Designer Cassette with Fabric Wrap 	<ul style="list-style-type: none"> Head rail is wrapped with matching shade fabric Head rail is white, black or oil rubbed bronze beneath the fabric wrap Hides the mechanism for a soft appearance from top to bottom 	<ul style="list-style-type: none"> Cord Loop Cordless Motorization 	<ul style="list-style-type: none"> White Ivory (New) Black Satin Nickel (New) Oil Rubbed Bronze All with fabric wrap	3¾" x 2⅞"	Standard
Designer Cassette with Metallic Finish 	<ul style="list-style-type: none"> Smooth finish head rail hides the roller shade mechanism High quality finish for a modern appearance 	<ul style="list-style-type: none"> Cord Loop Cordless Motorization 	<ul style="list-style-type: none"> White Ivory (New) Black Satin Nickel (New) Oil Rubbed Bronze 	3¾" x 2⅞"	Standard
Cordless with Deco-Bar 	<ul style="list-style-type: none"> Cord-free system Operates like a spring roller shade with a gentle pull on the bottom rail to raise and lower the shade Smooth and quiet operation Ideal from homes with children and pets Clear bottom grip included to ensure clean bottom rail 	<ul style="list-style-type: none"> Cordless 	<ul style="list-style-type: none"> White Black Ivory (New) Satin Nickel (New) Bronze (New) NEW Color Coordinated Bracket Covers	Shades to 72" 1½" x 2¼" Over 72" 1¾" x 2¾"	Standard Reverse
Simplicity Motorization 	<ul style="list-style-type: none"> Raise and lower shades at the push of a button; ideal for larger shades Child and pet safe Operate multiple shades simultaneously Battery wand included; power supply option available 	<ul style="list-style-type: none"> Simplicity 	<ul style="list-style-type: none"> Standard Roller Designer Cassette (All) 3" Fascia See above for color options	See Above Minimum Shade Width is 14"	Standard Reverse with Standard Roller
PowerTouch Rechargeable 	<ul style="list-style-type: none"> Raise & lower shading with the push of a button Eliminate the need to stand by the shading to operate; just touch and go Favorite position button Rechargeable battery with recharge port on pendant Features a favorite position 	<ul style="list-style-type: none"> Cordless Motorized 	<ul style="list-style-type: none"> Standard Roller Designer Cassette (All) Wand and Pendant available in white or black 	Designer Cassette: 3¾" x 2⅞" No Head Rail: Varies by shade size	Standard

COLOR LUX® ROLLER SHADES

Color Lux® Roller Shade Hardware Options

	Key Features	Control Options	Hardware Color Options	Hardware Size (Depth x Height)	Roll Style
Simplicity Rechargeable Motorization 	<ul style="list-style-type: none"> • Rechargeable Motor is fully integrated within the roller tube • No additional battery wand needs to be installed • Battery lasts 6 to 12 months between charges (varies by size and usage) 	<ul style="list-style-type: none"> • Simplicity 	<ul style="list-style-type: none"> • Standard Roller • Designer Cassette (All) <p>See above for color options</p>	<p>Minimum Shade Width is 18"</p> <p>Max size varies by fabric</p>	<p>Standard</p> <p>Reverse with Standard Roller</p>
Fascias 	<ul style="list-style-type: none"> • Conceals the Standard Roller hardware system • Available in 3" and 4" • Cornice look • Cord Loop and Motorization 	<ul style="list-style-type: none"> • Cord Loop • Motorization (3" Fascia Only) 	<ul style="list-style-type: none"> • Black • Brushed Aluminum • Vanilla • Bronze • White 	<p>3" x 3"</p> <p>4" x 4"</p>	<p>Standard</p>

Color Lux Roller Decorative Options

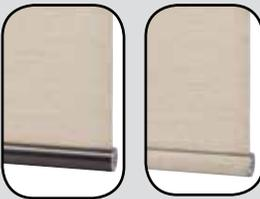
Highlights Cornice Valances 	<ul style="list-style-type: none"> • NEW Keystone for widths up to 216". Available in all Color Lux Roller Fabrics • Coordinate all your shades and décor for a unified look • Hide any roller hardware mechanism 	<ul style="list-style-type: none"> • Available as inside and outside mount • Seven return options to fit any window 	<ul style="list-style-type: none"> • Fabric Wrapped 	<p>Width: 24" to 216" (includes returns)</p> <p>Height: 6"</p> <p>Returns: 1 1/2" to 6"</p>	<p>NA</p>
Bottom Rails 	<ul style="list-style-type: none"> • Add an a decorative accent to bottom of your shade or fabric wrap the bottom rail for a soft look. • Two clear plastic end caps secure the fabric in place. 	<p>All hardware</p>	<ul style="list-style-type: none"> • White • Black • Bronze • Brushed Aluminum • Vanilla <p>For fabric wrap, rail colors are street side only</p>	<p>NA</p>	<p>NA</p>
Reverse Roll 	<ul style="list-style-type: none"> • The fabric rolls from the front of the roller, concealing the hardware. 	<ul style="list-style-type: none"> • Standard Roller • Cordless with Deco-Bar • Motorization 	<p>See page 85 for color options for your hardware selection</p>	<p>See pages 67 and 68 for hardware size</p>	<p>NA</p>
Standard Roll 	<ul style="list-style-type: none"> • Fabric rolls off the back of the roller 	<ul style="list-style-type: none"> • Standard Roller • Cordless with Deco-Bar • Motorization 	<p>See page 85 for color options for your hardware selection</p>	<p>See page 67 and 68 for hardware size</p>	<p>NA</p>

COLOR LUX® ROLLER SHADES

NEW Color Lux Skyline Hardware Roller Shades

The New Color Lux Skyline Roller Shade collection takes the popular roller shade system to a whole new level. Color Lux now provides beautiful new color coordination for various hardware options to provide ultimate roller shade design and quality. When ordering shades with Skyline Hardware, all of the components are color coordinated, from the clutch for cord loop shades all the way down to the tensioner. See pages 59 and 60 for pricing.

Skyline Hardware in White



Designer Cassette with Skyline Hardware



Standard Roller with Skyline Hardware



4" Skyline Fascia

Clutch, Cassette, Bead Chain, Brackets, Bracket Covers and Tensioner are in White

Skyline Hardware in Ivory



Designer Cassette with Skyline Hardware



Standard Roller with Skyline Hardware

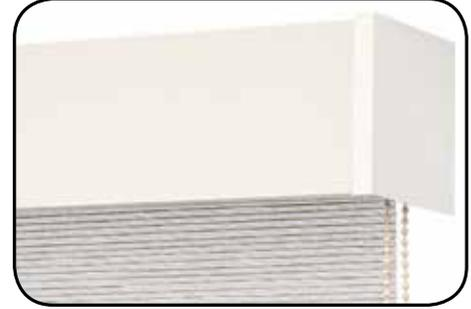

4" Skyline Fascia

Clutch, Cassette, Bead Chain, Brackets, Bracket Covers and Tensioner are in Ivory

Skyline Hardware in Black



Designer Cassette with Skyline Hardware



Standard Roller with Skyline Hardware

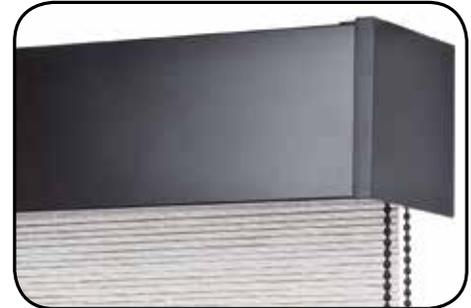

4" Skyline Fascia

Clutch, Cassette, Bead Chain, Brackets, Bracket Covers and Tensioner are in Black

NEW Color Lux Skyline Hardware Roller Shades

Skyline Hardware in Satin Nickel



Designer Cassette with Skyline Hardware

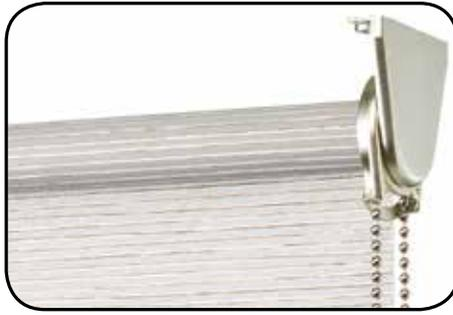

Standard Roller with Skyline Hardware

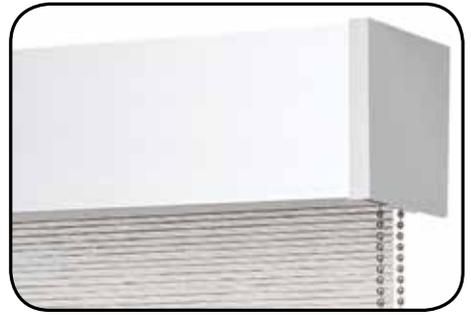

4" Skyline Fascia

Clutch, Cassette, Bead Chain, Bracket Covers and Tensioner are in Satin Nickel.

Skyline Hardware in Bronze



Designer Cassette with Skyline Hardware



Standard Roller with Skyline Hardware

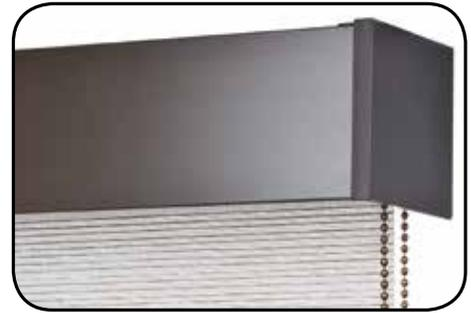

4" Skyline Fascia

Clutch, Cassette, Bead Chain, Brackets, Bracket Covers and Tensioner are in Bronze

NEW Dual Roller Shades



Black and White Brackets



Mix and Match Light Filtering and Blackout Fabrics

Dual Roller Shades are available with Remote Motorization and Cord Loop Control

COLOR LUX® ROLLER SHADES

NEW Color Lux Skyline Hardware Pricing and Surcharges

Cord Loop Options

See fabric pages 61 - 65 for fabric specifications.

Skyline Cord Loop Surcharge:

White, Ivory and Black Skyline Hardware	There is no surcharge for White, Ivory or Black Skyline Hardware
Bronze and Satin Nickel Skyline Hardware	Add \$27 to Standard Rectangular Price.

Skyline Cord Loop Hardware can be added to:

Designer Cassette (Add Designer Cassette surcharge found on pages 61 - 65)

4" Skyline Fascia

Two-on-One Head Rail (Price as two separate Roller Shades with Designer Cassette and add Skyline Surcharge)

Two-On-One Standard Roller

Dual Roller Shades (Add an additional \$27 for Dual Roller Shade Brackets. See pages 76 and 80 for more information)

4" Fascia with Skyline Cord Loop Hardware

	24	30	36	42	48	54	60	66	72	78	84	90	96	102	108	114	120
4" Skyline Fascia	61	67	69	70	80	92	101	111	122	130	142	154	161	170	182	191	200



Skyline Hardware in White



Skyline Hardware in Ivory



Skyline Hardware in Black



Skyline Hardware in Bronze



Skyline Hardware in Satin Nickel

NEW Color Lux Skyline Hardware Pricing and Surcharges

Motorization Options

See fabric pages 60- 65 for fabric specifications.

Skyline Motorization Surcharge

White, Ivory and Black Skyline Hardware	There is no surcharge for White, Ivory or Black Skyline Hardware
Bronze and Satin Nickel Skyline Hardware	Add \$27 to Standard Rectangular Price.

Skyline Motorization can be added to:

PowerTouch Rechargeable for Standard Roller (Roller Only)

Two-On-One Standard Roller (Roller Only)

Dual Roller Shades (Add an additional \$27 for Dual Roller Shade Brackets. See pages 76 and 80 for more information)

4" Fascia with Motorization

	24	30	36	42	48	54	60	66	72	78	84	90	96	102	108	114	120
4" Skyline Fascia	61	67	69	70	80	92	101	111	122	130	142	154	161	170	182	191	200

4" Skyline Fascia can be motorized with the following options:

PowerTouch Rechargeable	Add \$99 per shade
Simplicity Motorization	Add \$289 per shade
Simplicity Rechargeable Motorization	Add \$289 per shade

At least one charger is required for PowerTouch Rechargeable and Simplicity Rechargeable Motorization. Add \$26 per charger.

COLOR LUX® ROLLER SHADES



PowerTouch Rechargeable with Skyline Hardware in White



Motorized 4" Fascia in White



Motorized 4" Fascia Ivory



Motorized 4" Fascia in Black

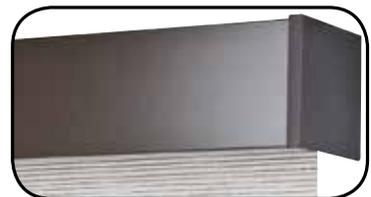

Motorized 4" Fascia in Bronze



Motorized 4" Fascia in Satin Nickel

Standard Roller Shade

Price Group 17 | Classic Duck Light Filtering

		Width In Inches																				
		24	30	36	42	48	54	60	66	72	78	84	90	96	102	106	112	118	124	130	136	144
Length In Inches	36	189	210	233	258	287	318	354	399	443	492	559	616	664	717	774	792	943	1028	1123	1227	1338
	42	194	215	239	266	295	327	363	410	455	505	574	632	682	737	795	811	968	1055	1155	1259	1376
	48	199	221	246	273	303	337	373	420	467	518	589	648	700	756	817	833	994	1084	1184	1293	1411
	54	206	226	251	279	310	344	383	431	479	531	605	664	719	776	838	855	1019	1112	1213	1325	1448
	60	210	233	258	286	318	353	392	443	492	545	619	681	735	794	857	874	1044	1139	1245	1358	1483
	66	215	238	265	294	326	362	402	452	503	558	634	698	753	814	879	897	1070	1167	1274	1392	1519
	72	220	245	271	302	334	370	411	464	515	571	650	714	772	833	901	918	1095	1196	1304	1425	1557
	78	225	249	278	307	341	378	420	475	526	585	664	730	789	853	920	940	1121	1223	1335	1459	1604
	84	230	255	283	314	349	388	431	484	539	597	680	748	808	872	941	960	1145	1251	1365	1489	1652
	90	236	261	290	322	357	396	439	496	551	611	694	764	825	907	972	982	1171	1279	1396	1524	1701
	96	241	267	296	330	365	404	448	507	561	624	710	782	844	946	995	1003	1197	1306	1426	1570	1752
	102	246	273	302	335	372	414	459	518	575	637	725	797	861	971	1015	1045	1233	1345	1469	1617	1805
	108	250	278	309	342	381	422	468	528	587	651	740	814	879	975	1048	1079	1270	1386	1513	1665	1859
	114	255	283	314	349	388	431	478	539	599	664	756	830	898	999	1078						
120	261	290	322	357	396	439	487	550	611	677	770	847	915	1015	1119							
126	266	295	328	365	403	448	496	560	623	691	785	864	935	1038	1134							
132	273	302	335	372	412	458	507	572	635	705	801	881	953	1059	1197							
138	278	307	341	379	420	467	517	584	648	719	817	899	972	1075	1218							
144	283	313	347	387	428	476	527	595	661	732	833	917	993	1118	1257							

Classic Duck Light Filtering: Minimum standard shade size is 12" x 12". Maximum shade width is 106" and it can be railroaded to a maximum width of 144" and a maximum length of 108".

Head Rail Options and Surcharges

Section 1 & 2	Available: Designer Cassette (All), Cordless Deco-Bar, Fascia (All), Motorization, PowerTouch Rechargeable, Standard Roller, and All Skyline Hardware
Section 3	Available: Standard Roller, Standard Skyline Roller, 4" Fascia, and 4" Skyline Fascia with Cord Loop (Dual Roller Not Available)
Section 4	Available: Standard Skyline Roller Only (Dual Roller Not Available)

See pages 59 and 60 for Skyline Hardware Options.

Designer Cassette	24	30	36	42	48	54	60	66	72	78	84	90	96	102	108	114	120
Select from White, Ivory, Black, Satin Nickel or Bronze Includes Smooth, Insert Strip and Fabric Wrap Option	74	80	86	92	98	106	113	120	127	122	129	140	145	149	154	176	198

Fascias	24	30	36	42	48	54	60	66	72	78	84	90	96	102	108	114	120
Three Inch Fascia	45	49	51	52	60	68	75	82	90	97	105	114	119	126	134	166	174
Four Inch Fascia	59	64	67	69	77	89	97	107	118	126	137	149	156	165	176	217	227

Cordless Roller

Cordless with Deco-Bar*	Add \$40
Cordless with Cassette	Add \$40 PLUS the Designer Cassette Surcharge to Standard Rectangular Price

*Minimum width is 19½", Maximum width is 96", Maximum length is 96"

Two on One Head Rail

Two on One Head Rail	Price as two separate roller shades with Designer Cassette option and add together.
----------------------	---

Highlights Cornice Valance	24	30	36	42	48	54	60	66	72	78	84	94	102	106	112	118	124	130	136	144
Highlights Cornice Valance (No Keystone)	76	84	92	99	108	113	119	125	130	135	141	150	Requires keystone. See pricing below							
Highlights Cornice Valance (with Keystone)	102	110	118	125	134	139	145	151	156	161	167	176	189	195	202	209	216	224	232	240

Highlights Valance with Keystone: All valances made over 94" wide will require a keystone (shaded area). See pages 77 - 79 for more information.

Scotchgard™ Stain Protection

Scotchgard™ Stain Protection	Add \$35 to the standard rectangular price
------------------------------	--

Bottom Rail Tassel Pulls: See page 83 for pricing and information.

Motorization: Available with Designer Cassette, 3" Fascia, 4" Skyline Fascia, and Standard Roller

Add below Motorization surcharges to base shade price, plus desired hardware option.

Simplicity Motorization Rechargeable and Non-Rechargeable	Add \$289 per shade
Simplicity 5 Channel Remote	Add \$40 per remote
NEW Simplicity 6 Channel Timer Remote	Add \$65 per remote
NEW PowerTouch Rechargeable:	Add \$99 per shade (available with and without cassette)
Simplicity Rechargeable Motor Battery Charger	Add \$26 per charger
*NEW Simplicity Smart Controller for Android and iPhone	Add \$330 per controller (see page 32 for more information)

Tube Information for Clutch Operated Shades Only
(Standard and Skyline):

- **Section 1:** Shades to the left of the dashed line requires a 1" tube/1" clutch
- **Section 2:** Shades to the right of the dashed line requires a 1½" tube/R8 clutch
- **Section 3:** Shades in the blue section requires a 2" tube/R16 clutch.
- **Section 4:** Shades in the orange section requires a 2½" tube/Galaxy 200 clutch

Standard Roller Shade

Price Group 18 | Classic Duck Blackout

Width In Inches

	24	30	36	42	48	54	60	66	72	78	84	90	96	102	106	112	118	124	130	136	144
36	208	231	256	284	316	350	389	439	487	541	615	678	730	789	851	870	1037	1132	1236	1350	1472
42	213	237	263	293	325	360	399	451	501	556	631	695	750	811	875	893	1065	1161	1271	1384	1514
48	219	243	271	300	333	371	410	462	514	570	648	713	770	832	899	916	1092	1193	1302	1422	1553
54	227	249	276	307	341	378	421	474	527	584	666	730	791	854	922	942	1121	1223	1335	1458	1600
60	231	256	284	315	350	388	431	487	541	600	681	749	809	873	943	962	1148	1253	1369	1494	1648
66	237	262	292	323	359	398	442	497	553	614	697	768	828	895	967	987	1178	1284	1401	1532	1697
72	242	270	298	332	367	407	452	510	567	628	715	785	849	916	991	1009	1204	1315	1434	1578	1748
78	248	274	306	338	375	416	462	523	579	644	730	803	868	938	1012	1034	1233	1346	1469	1625	1800
84	253	281	311	345	384	427	474	532	593	657	748	823	889	959	1035	1057	1260	1376	1513	1674	1854
90	260	287	319	354	393	436	483	546	606	672	763	840	908	998	1069	1080	1289	1407	1558	1724	1910
96	265	294	326	363	402	444	493	558	617	686	781	860	928	1041	1095	1103	1317	1437	1605	1776	1967
102	271	300	332	369	409	455	505	570	633	701	798	877	947	1068	1117	1136	1357	1480	1653	1829	2026
108	275	306	340	376	419	464	515	581	646	716	814	895	967	1073	1153	1170	1397	1525	1703	1884	2087
114	281	311	345	384	427	474	526	593	659	730	832	913	988	1099	1186						
120	287	319	354	393	436	483	536	605	672	745	847	932	1007	1117	1231						
126	293	325	361	402	443	493	546	616	685	760	864	950	1029	1142	1247						
132	300	332	369	409	453	504	558	629	699	776	881	969	1048	1165	1317						
138	306	338	375	417	462	514	569	642	713	791	899	989	1069	1183	1340						
144	311	344	382	426	471	524	580	655	727	805	916	1009	1092	1230	1383						

Classic Duck Blackout: Minimum standard shade size is 12" x 12". Maximum shade width is 106" and it can be railroded to a maximum width of 144" and a maximum length of 108"

Head Rail Options and Surcharges

Section 1 & 2	Available: Designer Cassette (All), Cordless Deco-Bar, Fascia (All), Motorization, PowerTouch Rechargeable, Standard Roller, and All Skyline Hardware
Section 3	Available: Standard Roller, Standard Skyline Roller, 4" Fascia, and 4" Skyline Fascia with Cord Loop (Dual Roller Not Available)
Section 4	Available: Standard Skyline Roller Only (Dual Roller Not Available)

See pages 59 and 60 for Skyline Hardware Options.

Designer Cassette	24	30	36	42	48	54	60	66	72	78	84	90	96	102	108	114	120
Select from White, Ivory, Black, Satin Nickel or Bronze Includes Smooth, Insert Strip and Fabric Wrap Option	74	80	86	92	98	106	113	120	127	122	129	140	145	149	154	176	198

Fascias	24	30	36	42	48	54	60	66	72	78	84	90	96	102	108	114	120
Three Inch Fascia	45	49	51	52	60	68	75	82	90	97	105	114	119	126	134	166	174
Four Inch Fascia	59	64	67	69	77	89	97	107	118	126	137	149	156	165	176	217	227

Cordless Roller

Cordless with Deco-Bar*	Add \$40
Cordless with Cassette	Add \$40 PLUS the Designer Cassette Surcharge to Standard Rectangular Price

*Minimum width is 19½", Maximum width is 96", Maximum length is 96"

Two on One Head Rail

Two on One Head Rail	Price as two separate roller shades with Designer Cassette option and add together.
----------------------	---

Highlights Cornice Valance	24	30	36	42	48	54	60	66	72	78	84	94	102	106	112	118	124	130	136	144	
Highlights Cornice Valance (No Keystone)	76	84	92	99	108	113	119	125	130	135	141	150	Requires keystone. See pricing below								
Highlights Cornice Valance (with Keystone)	102	110	118	125	134	139	145	151	156	161	167	176	189	195	202	209	216	224	232	240	

Highlights Valance with Keystone: All valances made over 94" wide will require a keystone (shaded area). See pages 77 - 79 for more information.

Scotchgard™ Stain Protection

Scotchgard™ Stain Protection	Add \$35 to the standard rectangular price
------------------------------	--

Bottom Rail Tassel Pulls: See page 83 for pricing and information.

Motorization: Available with Designer Cassette, 3" Fascia, 4" Skyline Fascia, and Standard Roller
Add below Motorization surcharges to base shade price, plus desired hardware option.

Simplicity Motorization	
Rechargeable and Non-Rechargeable	Add \$289 per shade
Simplicity 5 Channel Remote	Add \$40 per remote
NEW Simplicity 6 Channel Timer Remote	Add \$65 per remote
NEW PowerTouch Rechargeable:	Add \$99 per shade (available with and without cassette)
Simplicity Rechargeable Motor Battery Charger	Add \$26 per charger
*NEW Simplicity Smart Controller for Android and iPhone	Add \$330 per controller (see page 32 for more information)

Tube Information for Clutch Operated Shades Only (Standard and Skyline):

- **Section 1:** Shades to the left of the dashed line requires a 1" tube/1" clutch
- **Section 2:** Shades to the right of the dashed line requires a 1½" tube/R8 clutch
- **Section 3:** Shades in the blue section requires a 2" tube/R16 clutch.
- **Section 4:** Shades in the orange section requires a 2½" tube/Galaxy 200 clutch

COLOR LUX® ROLLER SHADES

Standard Roller Shade

Price Group 19 | Linen Light Filtering

		Width In Inches																				
		24	30	36	42	48	54	60	66	72	78	84	90	96	102	106	112	118	124	130	136	144
Length In Inches	36	208	231	256	284	316	350	389	439	487	541	615	678	730	789	851	871	1037	1131	1235	1350	1472
	42	213	237	263	293	325	360	399	451	501	556	631	695	750	811	875	892	1065	1161	1271	1385	1514
	48	219	243	271	300	333	371	410	462	514	570	648	713	770	832	899	916	1093	1192	1302	1422	1552
	54	227	249	276	307	341	378	421	474	527	584	666	730	791	854	922	941	1121	1223	1334	1458	1593
	60	231	256	284	315	350	388	431	487	541	600	681	749	809	873	943	961	1148	1253	1370	1494	1611
	66	237	262	292	323	359	398	442	497	553	614	697	768	828	895	967	987	1177	1284	1401	1531	1633
	72	242	270	298	332	367	407	452	510	567	628	715	785	849	916	991	1010	1205	1316	1434	1568	1657
	78	248	274	306	338	375	416	462	523	579	644	730	803	868	938	1012	1034	1233	1345	1469	1575	1800
	84	253	281	311	345	384	427	474	532	593	657	748	823	889	959	1035	1056	1260	1376	1417	1580	1854
	90	260	287	319	354	393	436	483	546	606	672	763	840	908	998	1069	1080	1288	1407	1449	1593	1910
	96	265	294	326	363	402	444	493	558	617	686	781	860	928	1041	1095	1103	1317	1437	1480	1776	1967
	102	271	300	332	369	409	455	505	570	633	701	798	877	947	1068	1117	1136	1357	1480	1653	1829	2026
	108	275	306	340	376	419	464	515	581	646	716	814	895	967	1073	1153	1170	1397	1525	1703	1884	2087
	114	281	311	345	384	427	474	526	593	659	730	832	913	988	1099	1186						
120	287	319	354	393	436	483	536	605	672	745	847	932	1007	1117	1231							
126	293	325	361	402	443	493	546	616	685	760	864	950	1029	1142	1247							
132	300	332	369	409	453	504	558	629	699	776	881	969	1048	1165	1317							
138	306	338	375	417	462	514	569	642	713	791	899	989	1069	1183	1340							
144	311	344	382	426	471	524	580	655	727	805	916	1009	1092	1230								

Color Lux Linen Light Filtering: Minimum standard shade size is 12" x 12". Maximum shade width is 106" and it can be railroaded to a maximum width of 144" and a maximum length of 108".

Head Rail Options and Surcharges

Section 1 & 2	Available: Designer Cassette (All), Cordless Deco-Bar, Fascia (All), Motorization, PowerTouch Rechargeable, Standard Roller, and All Skyline Hardware
Section 3	Available: Standard Roller, Standard Skyline Roller, 4" Fascia, and 4" Skyline Fascia with Cord Loop (Dual Roller Not Available)
Section 4	Available: Standard Skyline Roller Only (Dual Roller Not Available)

See pages 59 and 60 for Skyline Hardware Options.

Designer Cassette	24	30	36	42	48	54	60	66	72	78	84	90	96	102	108	114	120
Select from White, Ivory, Black, Satin Nickel or Bronze Includes Smooth, Insert Strip and Fabric Wrap Option	74	80	86	92	98	106	113	120	127	122	129	140	145	149	154	176	198

Fascias	24	30	36	42	48	54	60	66	72	78	84	90	96	102	108	114	120
Three Inch Fascia	45	49	51	52	60	68	75	82	90	97	105	114	119	126	134	166	174
Four Inch Fascia	59	64	67	69	77	89	97	107	118	126	137	149	156	165	176	217	227

Cordless Roller

Cordless with Deco-Bar*	Add \$40
Cordless with Cassette	Add \$40 PLUS the Designer Cassette Surcharge to Standard Rectangular Price

*Minimum width is 19½", Maximum width is 96", Maximum length is 96"

Two on One Head Rail

Two on One Head Rail	Price as two separate roller shades with Designer Cassette option and add together.
----------------------	---

Highlights Cornice Valance	24	30	36	42	48	54	60	66	72	78	84	94	102	106	112	118	124	130	136	144
Highlights Cornice Valance (No Keystone)	76	84	92	99	108	113	119	125	130	135	141	150	Requires keystone. See pricing below							
Highlights Cornice Valance (with Keystone)	102	110	118	125	134	139	145	151	156	161	167	176	189	195	202	209	216	224	232	240

Highlights Valance with Keystone: All valances made over 94" wide will require a keystone (shaded area). See pages 77 - 79 for more information.

Scotchgard™ Stain Protection

Scotchgard™ Stain Protection	Add \$35 to the standard rectangular price
------------------------------	--

Bottom Rail Tassel Pulls: See page 83 for pricing and information.

Motorization: Available with Designer Cassette, 3" Fascia, 4" Skyline Fascia, and Standard Roller

Add below Motorization surcharges to base shade price, plus desired hardware option.

Simplicity Motorization Rechargeable and Non-Rechargeable	Add \$289 per shade
Simplicity 5 Channel Remote	Add \$40 per remote
NEW Simplicity 6 Channel Timer Remote	Add \$65 per remote
NEW PowerTouch Rechargeable:	Add \$99 per shade (available with and without cassette)
Simplicity Rechargeable Motor Battery Charger	Add \$26 per charger
*NEW Simplicity Smart Controller for Android and iPhone	Add \$330 per controller (see page 32 for more information)

Tube Information for Clutch Operated Shades Only (Standard and Skyline):

- **Section 1:** Shades to the left of the dashed line requires a 1" tube/1" clutch
- **Section 2:** Shades to the right of the dashed line requires a 1½" tube/R8 clutch
- **Section 3:** Shades in the blue section requires a 2" tube/R16 clutch.
- **Section 4:** Shades in the orange section requires a 2½" tube/Galaxy 200 clutch

COLOR LUX® ROLLER SHADES

Standard Roller Shade

Price Group 20 | Linen Blackout

		Width In Inches																				
		24	30	36	42	48	54	60	66	72	78	84	90	96	102	106	112	118	124	130	136	144
Length In Inches	36	231	256	284	315	351	389	432	487	541	601	683	753	810	876	945	966	1151	1257	1372	1499	1634
	42	236	263	292	325	361	400	443	501	556	617	700	771	833	900	971	991	1182	1289	1411	1536	1681
	48	243	270	301	333	370	412	455	513	571	633	719	791	855	924	998	1017	1212	1324	1445	1578	1724
	54	252	276	306	341	379	420	467	526	585	648	739	810	878	948	1023	1046	1244	1358	1482	1618	1776
	60	256	284	315	350	389	431	478	541	601	666	756	831	898	969	1047	1068	1274	1391	1520	1658	1829
	66	263	291	324	359	398	442	491	552	614	682	774	852	919	993	1073	1096	1308	1425	1555	1708	1884
	72	269	300	331	369	407	452	502	566	629	697	794	871	942	1017	1100	1120	1336	1460	1592	1759	1940
	78	275	304	340	375	416	462	513	581	643	715	810	891	963	1041	1123	1148	1369	1494	1640	1812	1999
	84	281	312	345	383	426	474	526	591	658	729	830	914	987	1064	1149	1173	1399	1527	1689	1866	2059
	90	289	319	354	393	436	484	536	606	673	746	847	932	1008	1108	1187	1199	1431	1573	1740	1922	2120
	96	294	326	362	403	446	493	547	619	685	761	867	955	1030	1156	1215	1224	1462	1620	1792	1980	2184
	102	301	333	369	410	454	505	561	633	703	778	886	973	1051	1185	1240	1261	1506	1669	1846	2039	2249
	108	305	340	377	417	465	515	572	645	717	795	904	993	1073	1191	1280	1299	1551	1719	1901	2100	2317
	114	312	345	383	426	474	526	584	658	731	810	924	1013	1097	1220	1316						
120	319	354	393	436	484	536	595	672	746	827	940	1035	1118	1240	1366							
126	325	361	401	446	492	547	606	684	760	844	959	1055	1142	1268	1384							
132	333	369	410	454	503	559	619	698	776	861	978	1076	1163	1293								
138	340	375	416	463	513	571	632	713	791	878	998	1098	1187	1313								
144	345	382	424	473	523	582	644	727	807	894	1017	1120	1212	1365								

Color Lux Linen Blackout: Minimum standard shade size is 12" x 12". Maximum shade width is 106" and it can be railroaded to a maximum width of 144" and a maximum length of 108"

Head Rail Options and Surcharges

Section 1 & 2	Available: Designer Cassette (All), Cordless Deco-Bar, Fascia (All), Motorization, PowerTouch Rechargeable, Standard Roller, and All Skyline Hardware
Section 3	Available: Standard Roller, Standard Skyline Roller, 4" Fascia, and 4" Skyline Fascia with Cord Loop (Dual Roller Not Available)
Section 4	Available: Standard Skyline Roller Only (Dual Roller Not Available)

See pages 59 and 60 for Skyline Hardware Options.

Designer Cassette	24	30	36	42	48	54	60	66	72	78	84	90	96	102	108	114	120
Select from White, Ivory, Black, Satin Nickel or Bronze Includes Smooth, Insert Strip and Fabric Wrap Option	74	80	86	92	98	106	113	120	127	122	129	140	145	149	154	176	198

Fascias	24	30	36	42	48	54	60	66	72	78	84	90	96	102	108	114	120
Three Inch Fascia	45	49	51	52	60	68	75	82	90	97	105	114	119	126	134	166	174
Four Inch Fascia	59	64	67	69	77	89	97	107	118	126	137	149	156	165	176	217	227

Cordless Roller

Cordless with Deco-Bar*	Add \$40
Cordless with Cassette	Add \$40 PLUS the Designer Cassette Surcharge to Standard Rectangular Price

*Minimum width is 19.5"; Maximum Width is 90"; Maximum Length is 84"

Two on One Head Rail

Two on One Head Rail	Price as two separate roller shades with Designer Cassette option and add together.
----------------------	---

Highlights Cornice Valance	24	30	36	42	48	54	60	66	72	78	84	94	102	106	112	118	124	130	136	144
Highlights Cornice Valance (No Keystone)	76	84	92	99	108	113	119	125	130	135	141	150	Requires keystone. See pricing below							
Highlights Cornice Valance (with Keystone)	102	110	118	125	134	139	145	151	156	161	167	176	189	195	202	209	216	224	232	240

Highlights Valance with Keystone: All valances made over 94" wide will require a keystone (shaded area). See pages 77 - 79 for more information.

Scotchgard™ Stain Protection

Scotchgard™ Stain Protection	Add \$35 to the standard rectangular price
------------------------------	--

Bottom Rail Tassel Pulls: See page 83 for pricing and information.

Motorization: Available with Designer Cassette, 3" Fascia, 4" Skyline Fascia, and Standard Roller

Add below Motorization surcharges to base shade price, plus desired hardware option.

Simplicity Motorization Rechargeable and Non-Rechargeable	Add \$289 per shade
Simplicity 5 Channel Remote	Add \$40 per remote
NEW Simplicity 6 Channel Timer Remote	Add \$65 per remote
NEW PowerTouch Rechargeable:	Add \$99 per shade (available with and without cassette)
Simplicity Rechargeable Motor Battery Charger	Add \$26 per charger
*NEW Simplicity Smart Controller for Android and iPhone	Add \$330 per controller (see page 32 for more information)

Tube Information for Clutch Operated Shades Only (Standard and Skyline):

- **Section 1:** Shades to the left of the dashed line requires a 1" tube/1" clutch
- **Section 2:** Shades to the right of the dashed line requires a 1 1/2" tube/R8 clutch
- **Section 3:** Shades in the blue section requires a 2" tube/R16 clutch.
- **Section 4:** Shades in the orange section requires a 2 1/2" tube/Galaxy 200 clutch

Standard Roller Shade

Price Group 21 | Solar Screen 5

Length In Inches	Width In Inches																					
	24	30	36	42	48	54	60	66	72	78	84	90	96	102	106	112	118	124	130	136	144	
36	208	231	256	284	316	350	389	439	487	541	615	678	730	789	851	871	1037	1131	1235	1350	1472	
42	213	237	263	293	325	360	399	451	501	556	631	695	750	811	875	892	1065	1161	1271	1385	1514	
48	219	243	271	300	333	371	410	462	514	570	648	713	770	832	899	916	1093	1192	1302	1422	1552	
54	227	249	276	307	341	378	421	474	527	584	666	730	791	854	922	941	1121	1223	1334	1458	1593	
60	231	256	284	315	350	388	431	487	541	600	681	749	809	873	943	961	1148	1253	1370	1494	1611	
66	237	262	292	323	359	398	442	497	553	614	697	768	828	895	967	987	1177	1284	1401	1531	1633	
72	242	270	298	332	367	407	452	510	567	628	715	785	849	916	991	1010	1205	1316	1434	1568	1657	
78	248	274	306	338	375	416	462	523	579	644	730	803	868	938	1012	1034	1233	1345	1469	1575	1673	
84	253	281	311	345	384	427	474	532	593	657	748	823	889	959	1035	1056	1260	1376	1417	1580	1684	
90	260	287	319	354	393	436	483	546	606	672	763	840	908	998	1069	1080	1288	1407	1449	1593	1698	
96	265	294	326	363	402	444	493	558	617	686	781	860	928	1041	1095	1103	1317	1437	1480	1610	1723	
102	271	300	332	369	409	455	505	570	633	701	798	877	947	1068	1117	1117	1136	1357	1480	1524	1658	1775
108	275	306	340	376	419	464	515	581	646	716	814	895	967	1073	1153	1153	1170	1397	1525	1570	1708	1828
114	281	311	345	384	427	474	526	593	659	730	832	913	988	1099	1186							
120	287	319	354	393	436	483	536	605	672	745	847	932	1007	1117	1231							
126	293	325	361	402	443	493	546	616	685	760	864	950	1029	1142	1247							
132	300	332	369	409	453	504	558	629	699	776	881	969	1048	1165	1317							
138	306	338	375	417	462	514	569	642	713	791	899	989	1069	1183	1340							
144	311	344	382	426	471	524	580	655	727	805	916	1009	1092	1230	1366							

Solar Screen 5: Minimum standard shade size is 12" x 12". Maximum shade width is 114" and it can be railroaded to a maximum width of 144" and a maximum length of 108".

Head Rail Options and Surcharges

Section 1 & 2	Available: Designer Cassette (All), Cordless Deco-Bar, Fascia (All), Motorization, PowerTouch Rechargeable, Standard Roller, and All Skyline Hardware
Section 3	Available: Standard Roller, Standard Skyline Roller, 4" Fascia, and 4" Skyline Fascia with Cord Loop (Dual Roller Not Available)
Section 4	Available: Standard Skyline Roller Only (Dual Roller Not Available)

See pages 59 and 60 for Skyline Hardware Options.

Designer Cassette	24	30	36	42	48	54	60	66	72	78	84	90	96	102	108	114	120
Select from White, Ivory, Black, Satin Nickel or Bronze Includes Smooth and Insert Strip Option	74	80	86	92	98	106	113	120	127	122	129	140	145	149	154	176	198

Fabric Wrapped Designer Cassette is not available with Solar Screen 5

Fascias	24	30	36	42	48	54	60	66	72	78	84	90	96	102	108	114	120
Three Inch Fascia	45	49	51	52	60	68	75	82	90	97	105	114	119	126	134	166	174
Four Inch Fascia	59	64	67	69	77	89	97	107	118	126	137	149	156	165	176	217	227

Cordless Roller

Cordless with Deco-Bar*	Add \$40
Cordless with Cassette	Add \$40 PLUS the Designer Cassette Surcharge to Standard Rectangular Price

*Minimum width is 19½", Maximum width is 96", Maximum length is 96"

Two on One Head Rail

Two on One Head Rail	Price as two separate roller shades with Designer Cassette option and add together.
----------------------	---

Highlights Cornice Valance	24	30	36	42	48	54	60	66	72	78	84	94	102	106	112	118	124	130	136	144
Highlights Cornice Valance (No Keystone)	76	84	92	99	108	113	119	125	130	135	141	150	Requires keystone. See pricing below							
Highlights Cornice Valance (with Keystone)	102	110	118	125	134	139	145	151	156	161	167	176	189	195	202	209	216	224	232	240

Highlights Valance with Keystone: All valances made over 94" wide will require a keystone (shaded area). See pages 77 - 79 for more information.

Scotchgard™ Stain Protection

Scotchgard™ Stain Protection	Add \$35 to the standard rectangular price
------------------------------	--

Bottom Rail Tassel Pulls: See page 83 for pricing and information.

Motorization: Available with Designer Cassette, 3" Fascia, 4" Skyline Fascia, and Standard Roller

Add below Motorization surcharges to base shade price, plus desired hardware option.

Simplicity Motorization	
Rechargeable and Non-Rechargeable	Add \$289 per shade
Simplicity 5 Channel Remote	Add \$40 per remote
NEW Simplicity 6 Channel Timer Remote	Add \$65 per remote
NEW PowerTouch Rechargeable:	Add \$99 per shade (available with and without cassette)
Simplicity Rechargeable Motor Battery Charger	Add \$26 per charger
*NEW Simplicity Smart Controller for Android and iPhone	Add \$330 per controller (see page 32 for more information)

Tube Information for Clutch Operated Shades Only (Standard and Skyline):

- **Section 1:** Shades to the left of the dashed line requires a 1" tube/1" clutch
- **Section 2:** Shades to the right of the dashed line requires a 1½" tube/R8 clutch
- **Section 3:** Shades in the blue section requires a 2" tube/R16 clutch.
- **Section 4:** Shades in the orange section requires a 2½" tube/Galaxy 200 clutch

COLOR LUX® ROLLER SHADES

Color Lux® Roller Shade Fabric Information

Choosing the Right Color Lux Roller Fabric

What are the fabric contents of each fabric?

- Classic Duck Light Filtering is 100% Polyester
- Classic Duck Blackout is 100% Polyester
- NEW Linen Light Filtering is 100% Polyester
- NEW Linen Blackout is 100% Polyester with a foam coated backing
- NEW Solar Screen 5 is 36% Polyester, 51% FR Polyester and 13% Cationic Polyester

Classic Duck Light Filtering and Blackout Fabrics

Classic Duck provides the perfect canvas for all 800 Color Lux colors. A simple weave works well with any complementary fabric textures. Available in Light Filtering and Blackout.

NEW Linen Light Filtering and Blackout Fabrics

NEW Linen provides the natural timeless look of linen fabric into Color Lux Roller Shades. Light Filtering allows in just the right amount of opacity to maintain privacy but allow light into the home. Linen Blackout is perfect for bedroom and media room applications.

NEW Solar Screen 5 Fabric

NEW Solar Screen 5 is the perfect balance of function and design. With a 5% openness factor, Solar Screen 5 provides light and privacy. Color Lux Color 100 Ultra White has passed the NFPA and California Title 19 Fire Rating Standards. Solar Screen 5 also offers a subtle linen texture that enhances every decor style.

What are the fabric properties of Solar Screen 5?

The below ratings apply to **Color Lux Color 100 Ultra White Only**

	TS	RS	AS	TV	OF	SHGC/G Value		Fire Rating
						Commercial SHGC % Improvement	Residential SHGC	
Solar Screen 5								
100 Ultra White*	39	56	5	38	5.00	39%	0.42	NFPA 701-10 TM#1, California U.S. Title 19
ISO 14001:2004 OEKO-TEX® Standard 100 OEKO-TEX® Standard 1000 Zero Landfill Water Conservation and Usage Use of Recycled Materials								

* Fire Rating and other properties apply to Ultra White (Color Lux Color 100) only

To be certified with OEKO-TEX® Standard 100, companies have to meet defined criteria regarding their environmentally friendly and socially acceptable production process at all production stages (International Association for Research and Testing in the Field of Textile Ecology)

- TS = Solar Transmittance
- RS = Solar Reflectance
- AS = Solar Absorptance
- TV = Visual Transmittance
- OF = Openness Factor
- 1/4 CL = 1/4" Clear Glass
- 1/4 HA = 1/4" Heat Absorbing Glass

COLOR LUX® ROLLER SHADES

Color Lux® Roller Shade Head Rail Options

Standard Roller

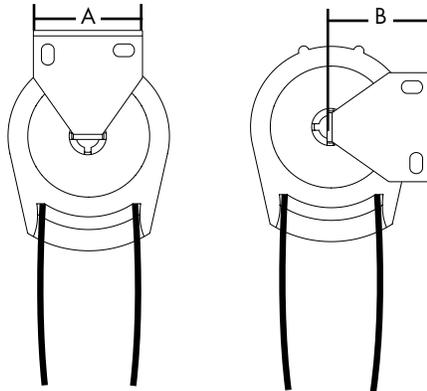

Standard Tube (1" and 1½" diameter):

A = 1½"

B = 1½" Or 2"

Oversized Tube (2" diameter):

A = 2"

B = 1⅝" Or 2⅛"

Hardware Features		
Roll Style:	Standard or reverse (reverse roll information is found on page 85)	
Bead Cord Style and Color:	White, black, bronze or steel bead chain	
Clutch Color:	White or black. Outside mount shades include black or white bracket covers	
Bottom Rail Style:	Fabric Wrapped or Exposed Bottom Rail	
Bottom Rail Color:	Fabric Wrapped: White, vanilla, bronze, black or brushed aluminum Exposed: White, vanilla, bronze, black or brushed aluminum	
Motorization	Standard Roller Hardware can be motorized with Simplicity Motorization (non-rechargeable or rechargeable) or PowerTouch™ Rechargeable. See grids for pricing and pages 86 - 91 for details.	
Mounting Dimensions	For proper placement of mounting brackets for inside and exact mount, see www.comfortextdealers.com/installationinstructions.html in the roller shade section.	
The standard 1" and 1½" tubes are available with two brackets in 1½" and 2" projection.		
Minimum depth for flush inside mount including installation brackets: 2½"		
The oversized 2" tube is available with two brackets in 1⅝" and 2⅛" projection.		
Minimum depth for flush inside mount including installation brackets: 3"		
Standard Roller Finished Dimensions (Applies to Cord Loop and Motorized)	Standard Tube (1" and 1½" diameter)	Oversized Tube (2" diameter)
Inside Mount*		
* Inside mount brackets must be mounted up or to the back of the mounting surface. Select side mount if mounting to the side of the mounting surface. Width and length measurements may vary +/- ⅛" for all roller hardware options.		
Bracket to Bracket Measurement:	Ordered width minus ⅜"	Ordered width minus ⅜"
End to End Roller Width:	Ordered width minus 1¼"	Ordered width minus 1⅜"
Fabric Width:	Ordered width minus 1⅝"	Ordered width minus 1⅞"
Bottom Rail Width:	Ordered width minus 1⅝"	Ordered width minus 1⅞"
Outside Mount		
Bracket to Bracket Measurement:	Ordered width plus ⅜"	Ordered width plus ⅜"
End to End Roller Width:	Ordered width minus 7⁄8"	Ordered width minus 1"
Fabric Width:	Ordered width minus 1⅝"	Ordered width minus 1⅞"
Bottom Rail Width:	Ordered width minus 1⅝"	Ordered width minus 1⅞"
Side and Exact Mount		
Bracket to Bracket Measurement:	Ordered width	Ordered width
End to End Roller Width:	Ordered width minus 1⅞"	Ordered width minus 1⅞"
Fabric Width:	Ordered width minus 1⅞"	Ordered width minus 1¼"
Bottom Rail Width:	Ordered width minus 1⅞"	Ordered width minus 1¼"

Color Lux® Roller Shade Head Rail Options

Skyline Standard Roller Shades

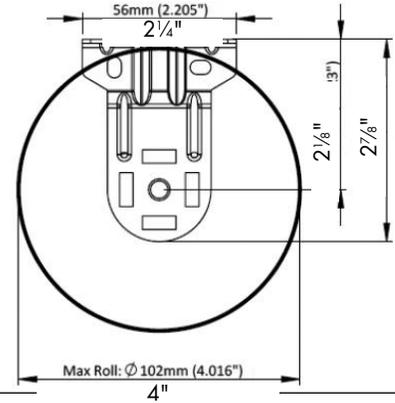
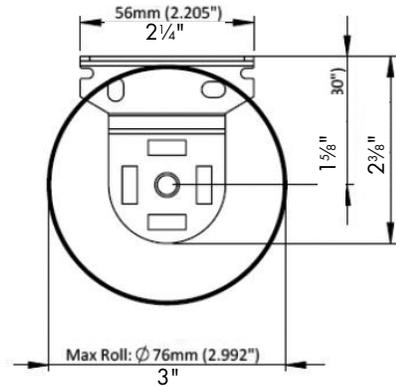

Hardware Features

Roll Style:	Standard or reverse (reverse roll information is found on page 85)
Bead Chain Color:	White, Black, Ivory, Satin Nickel and Bronze
Clutch Color:	White, Black, Ivory, Satin Nickel and Bronze
Bracket Cover Colors:	White, Black, Ivory, Satin Nickel and Bronze
Bracket Colors:	White, Black, Ivory and Bronze
Bottom Rail Style:	Fabric Wrapped or Exposed Bottom Rail
Bottom Rail Color:	Fabric Wrapped: White, Black, Ivory, Brushed Aluminum and Bronze Exposed: White, Black, Ivory, Brushed Aluminum and Bronze
Motorization	Skyline Standard Roller Hardware can be motorized with Simplicity Motorization (non-rechargeable or rechargeable) or PowerTouch™ Rechargeable. See grids for pricing and pages 86 - 91 for details.

Mounting Dimensions

The standard 1" and 1 1/2" tubes are available with two brackets in 1 5/8" or 2 1/8" projection.
Minimum depth for flush inside or side mount including installation brackets: 2 1/4"
The oversized 2" tube is available with one bracket in a 2 1/8" projection.
Minimum depth for flush inside mount including installation brackets: 3"

Standard Roller Finished Dimensions (Cord Loop or Motorized)	Standard Tube Cord Loop (1" and 1 1/2" diameter)	Standard Tube Motorized (1 1/2" diameter)	Oversized Tube Cord Loop (2" diameter)	Oversized Tube Cord Loop (2 1/2" diameter)
Inside Mount				
Bracket to Bracket Measurement:	Ordered width	Ordered width	Ordered width	Ordered width
End to End Roller Width:	Ordered width minus 1"	Ordered width minus 1 1/8"	Ordered width minus 1 1/16"	Ordered width minus 1 1/4"
Fabric Width:	Ordered width minus 1 1/16"	Ordered width minus 1 3/16"	Ordered width minus 1 1/8"	Ordered width minus 1 5/16"
Bottom Rail Width:	Ordered width minus 1 1/16"	Ordered width minus 1 3/16"	Ordered width minus 1 1/8"	Ordered width minus 1 5/16"
Outside Mount and Inside Mount with Bracket Covers				
End Cap Cover to End Cap Cover:	Ordered width	Ordered width	Ordered width	Ordered width
Bracket to Bracket Measurement:	Ordered width minus 1/8"	Ordered width minus 1/4"	Ordered width minus 1/8"	Ordered width minus 1 1/8"
End to End Roller Width:	Ordered width minus 1 1/8"	Ordered width minus 1 1/4"	Ordered width minus 1 3/16"	Ordered width minus 1 3/8"
Fabric Width:	Ordered width minus 1 3/16"	Ordered width minus 1 5/16"	Ordered width minus 1 1/4"	Ordered width minus 1 7/16"
Bottom Rail Width:	Ordered width minus 1 3/16"	Ordered width minus 1 5/16"	Ordered width minus 1 1/4"	Ordered width minus 1 7/16"

COLOR LUX® ROLLER SHADES

Color Lux® Roller Shade Head Rail Options

Cordless Roller with Deco-Bar Mounting Rail



Shades Measuring 19½" to 72":

- A = 1½"
- B = 1⅝"
- C = 2¼"
- D = 1¼" Roller

Shades Measuring 72" to Maximum Width:

- A = 1¾"
- B = 1¾"
- C = 2¾"
- D = 1½" Roller

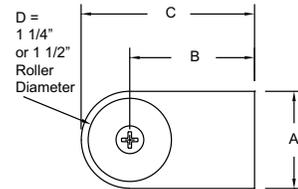
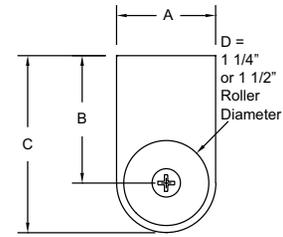

Head Rail Consistency

Cordless Roller with Deco-Bar Shades under 72" wide utilize a 1¼" roller and shades over 72" wide utilize a 1½" roller. If an order has multiple shades with varying widths, be aware of potential tube size inconsistencies. Fabric will add an average of ⅛" to the diameter of the tube for every 10" of fabric rolled onto the tube. Contact Technical Services if additional services is needed.

Hardware Features

Roll Style:	Standard or reverse (reverse roll information is found on page 85)
Hardware Color:	White, Ivory, Black, Satin Nickel and Bronze (brackets are white or black)
Bracket Covers:	White, Ivory, Black, Satin Nickel and Bronze
Bottom Rail Style:	Fabric Wrapped or Exposed Bottom Rail
Bottom Rail Color:	Fabric Wrapped: White, vanilla, bronze, black or brushed aluminum Exposed: White, vanilla, bronze, black or brushed aluminum
Motorization	Cordless Roller with Deco-Bar cannot be motorized.
Head Rail Surcharge	See price grids for Cordless surcharge information.

Mounting Dimensions

Minimum depth for flush inside mount including installation brackets: 1¾"

Minimum inside mounting height: 1¼"

Minimum outside mounting height: 1"

Cordless Roller with Deco-Bar Finished Dimensions

Inside Mount

Head Rail Measurement:	Ordered width minus ⅜" (measurement includes end brackets)
Fabric Width:	Ordered width minus 1⅜"

Inside Mount with NEW Bracket Covers

Head Rail Measurement:	Ordered width minus 7/16"
Fabric Width:	Ordered width minus 1 1/16"

Outside Mount

Head Rail Measurement:	Ordered width plus ⅜" (measurement includes end brackets)
Fabric Width:	Ordered width minus 7/16"

Side Mount

Head Rail Measurement:	Ordered width minus 1 1/16" (measurement includes end brackets)
Fabric Width:	Ordered width minus 1 5/16"

Exact End to End Mount

Head Rail Measurement:	Ordered width (measurement includes end brackets)
Fabric Width:	Ordered width minus 5/8"

Color Lux® Roller Shade Head Rail Options Designer Cassette with Insert Strip

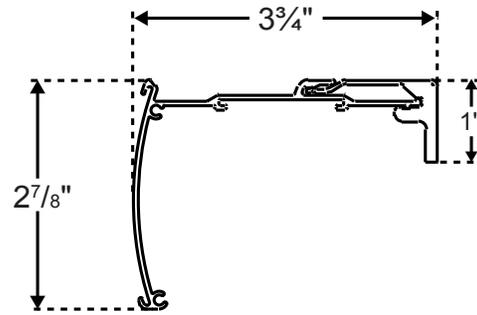

COLOR LUX® ROLLER SHADES

Hardware Features

Roll Style:	Standard only
Head Rail Color:	White, Ivory, Black, Satin Nickel and Bronze with matching fabric insert strip Skyline Clutch is available in White, Ivory, Black, Satin Nickel and Bronze
Bottom Rail Style:	Fabric Wrapped or Exposed Bottom Rail
Bottom Rail Color:	Fabric Wrapped: White, vanilla, bronze, black or brushed aluminum Exposed: White, vanilla, bronze, black or brushed aluminum
Bead Chain Color:	White, ivory, black, bronze or steel bead chain
Operation Options:	Cord Loop: Select bead chain color, bottom rail style and color Cordless: Select bottom rail style and color
Motorization	Designer Cassette can be motorized with Simplicity Motorization (non-rechargeable or rechargeable) or PowerTouch™ Rechargeable. See grids for pricing and pages 86 - 91 for details.
Cassette Surcharge	See price grids for surcharge information.

Mounting Dimensions

Minimum depth for flush inside mount including installation brackets:	3 3/4"
Minimum depth required for shallow mounting:	1"
Minimum depth for side mount:	1 1/8" • Maximum shade width for side mount: 48"
Minimum height required for outside mounting:	1"

Designer Cassette Finished Head Rail Measurements for Cord Loop, Cordless and Motorized Shades

Inside Mount	
Head Rail Measurement:	Ordered width minus 3/16" (measurement includes end caps)
Outside Mount	
Head Rail Measurement:	Ordered width plus 3/16" (measurement includes end caps)
Side Mount	
Head Rail Measurement:	Ordered width minus 1 1/16" (measurement includes end caps)
Exact End to End Mount	
Head Rail Measurement:	Ordered width (measurement includes end caps)

Designer Cassette Finished Fabric Measurements

Mount	Cord Loop & Motorized	Cordless	Skyline Cord Loop
Inside Mount:	Ordered width minus 1 1/16"	Ordered width minus 1"	Ordered width minus 1 1/4"
Outside Mount:	Ordered width minus 1 1/16"	Ordered width minus 5/8"	Ordered width minus 7/8"
Side Mount:	Ordered width minus 1 9/16"	Ordered width minus 1 1/2"	Ordered width minus 1 3/4"
Exact End to End Mount:	Ordered width minus 7/8"	Ordered width minus 1 3/16"	Ordered width minus 1 1/16"

Color Lux® Roller Shade Head Rail Options

Fabric Wrapped Designer Cassette

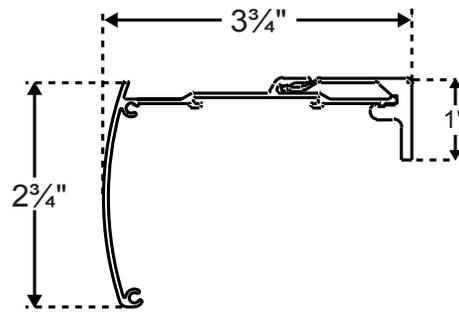

Hardware Features	
Roll Style:	Standard only
Head Rail Color:	White, Ivory, Black, Satin Nickel and Bronze with Fabric Wrap Skyline Clutch is available in White, Ivory, Black, Satin Nickel and Bronze
Bottom Rail Style:	Fabric Wrapped or Exposed Bottom Rail
Bottom Rail Color:	Fabric Wrapped: White, vanilla, bronze, black or brushed aluminum Exposed: White, vanilla, bronze, black or brushed aluminum
Bead Chain Color:	White, black, bronze or steel bead chain
Operation Options:	Cord Loop: Select bead chain color, bottom rail style and color Cordless: Select bottom rail style and color
Motorization	Designer Cassette can be motorized with Simplicity Motorization (non-rechargeable or rechargeable) or PowerTouch™ Rechargeable. See grids for pricing and pages 86 - 91 for details.
Cassette Surcharge	See price grids for surcharge information.

Mounting Dimensions	
Minimum depth for flush inside mount including installation brackets: 3 3/4"	
Minimum depth required for shallow mounting: 1"	
Minimum depth for side mount: 1 1/8" • Maximum shade width for side mount: 48"	
Minimum height required for outside mounting: 1"	

Designer Cassette Finished Head Rail Measurements for Cord Loop, Cordless and Motorized Shades

Inside Mount	
Head Rail Measurement:	Ordered width minus 3/16" (measurement includes end caps)
Outside Mount	
Head Rail Measurement:	Ordered width plus 3/16" (measurement includes end caps)
Side Mount	
Head Rail Measurement:	Ordered width minus 1 1/16" (measurement includes end caps)
Exact End to End Mount	
Head Rail Measurement:	Ordered width (measurement includes end caps)

Designer Cassette Finished Fabric Measurements			
Mount	Cord Loop & Motorized	Cordless	Skyline Cord Loop
Inside Mount:	Ordered width minus 1 1/16"	Ordered width minus 1"	Ordered width minus 1 1/4"
Outside Mount:	Ordered width minus 1 1/16"	Ordered width minus 5/8"	Ordered width minus 7/8"
Side Mount:	Ordered width minus 1 9/16"	Ordered width minus 1 1/2"	Ordered width minus 1 3/4"
Exact End to End Mount:	Ordered width minus 7/8"	Ordered width minus 13/16"	Ordered width minus 1 1/16"

COLOR LUX® ROLLER SHADES

Color Lux® Roller Shade Head Rail Options Designer Cassette with Smooth Face

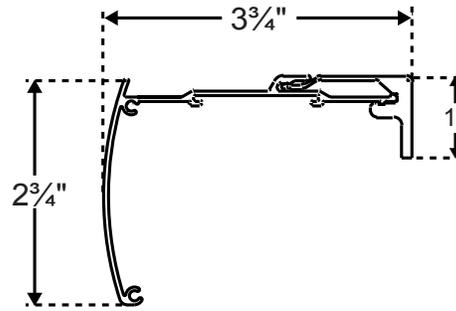

COLOR LUX® ROLLER SHADES

Hardware Features	
Roll Style:	Standard only
Head Rail Color:	White, Ivory, Black, Satin Nickel and Bronze Skyline Clutch is available in White, Ivory, Black, Satin Nickel and Bronze
Bottom Rail Style:	Fabric Wrapped or Exposed Bottom Rail
Bottom Rail Color:	Fabric Wrapped: White, vanilla, bronze, black or brushed aluminum Exposed: White, vanilla, bronze, black or brushed aluminum
Bead Chain Color:	White, black, bronze or steel bead chain
Operation Options:	Cord Loop: Select bead chain color, bottom rail style and color Cordless: Select bottom rail style and color
Motorization	Designer Cassette can be motorized with Simplicity Motorization (non-rechargeable or rechargeable) or PowerTouch™ Rechargeable. See grids for pricing and pages 86 - 91 for details.
Cassette Surcharge	See price grids for surcharge information.

Mounting Dimensions	
Minimum depth for flush inside mount including installation brackets: 3 3/4"	
Minimum depth required for shallow mounting: 1"	
Minimum depth for side mount: 1 1/8" • Maximum shade width for side mount: 48"	
Minimum height required for outside mounting: 1"	

Designer Cassette Finished Head Rail Measurements for Cord Loop, Cordless and Motorized Shades	
Inside Mount	
Head Rail Measurement:	Ordered width minus 3/16" (measurement includes end caps)
Outside Mount	
Head Rail Measurement:	Ordered width plus 3/16" (measurement includes end caps)
Side Mount	
Head Rail Measurement:	Ordered width minus 1 1/16" (measurement includes end caps)
Exact End to End Mount	
Head Rail Measurement:	Ordered width (measurement includes end caps)

Designer Cassette Finished Fabric Measurements			
Mount	Cord Loop & Motorized	Cordless	Skyline Cord Loop
Inside Mount:	Ordered width minus 1 1/16"	Ordered width minus 1"	Ordered width minus 1 1/4"
Outside Mount:	Ordered width minus 1 1/16"	Ordered width minus 5/8"	Ordered width minus 7/8"
Side Mount:	Ordered width minus 1 9/16"	Ordered width minus 1 1/2"	Ordered width minus 1 3/4"
Exact End to End Mount:	Ordered width minus 7/8"	Ordered width minus 1 3/16"	Ordered width minus 1 1/16"

Color Lux® Roller Shade Head Rail Options

3" Fascia

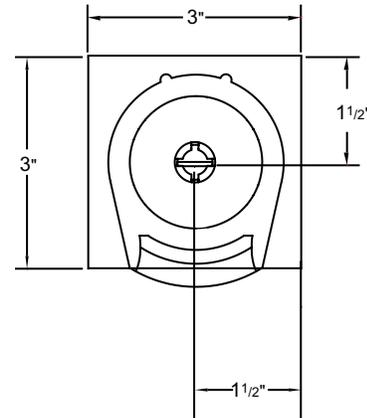
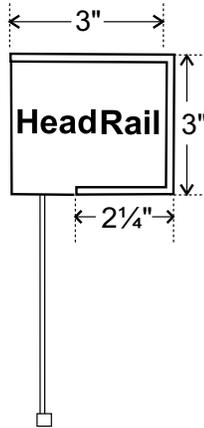

Hardware Features	
Fascia Colors:	Black, Bronze, Brushed Aluminum, White and Vanilla
Roll Style:	Standard only
Bead Chain Color:	White, black, bronze or steel bead chain
Bottom Rail Style:	Fabric Wrapped or Exposed Bottom Rail
Bottom Rail Color:	Fabric Wrapped: White, vanilla, bronze, black or brushed aluminum Exposed: White, vanilla, bronze, black or brushed aluminum
Motorization	Three Inch Fascia Hardware can be motorized with Simplicity Motorization (not available with Simplicity Rechargeable or PowerTouch Rechargeable). See pages 88 - 89 for details.
Head Rail Surcharge	See price grids for surcharge information.
Mounting Dimensions	
Minimum depth for flush inside mount including installation brackets: 3"	
Minimum surface height required for outside mount: 3"	

Three Inch Fascia Finished Dimensions	Standard Tube (1" and 1 1/2" diameter)	Oversized Tube (2" diameter)
Inside Mount		
Bracket to Bracket Measurement:	Ordered width minus 3/16"	Ordered width minus 3/16"
End to End Roller Width:	Ordered width minus 1 1/4"	Ordered width minus 1 3/8"
Fabric Width:	Ordered width minus 1 5/16"	Ordered width minus 1 7/16"
Bottom Rail Width:	Ordered width minus 1 5/16"	Ordered width minus 1 7/16"
Outside Mount		
Bracket to Bracket Measurement:	Ordered width plus 3/16"	Ordered width plus 3/16"
End to End Roller Width:	Ordered width minus 7/8"	Ordered width minus 1"
Fabric Width:	Ordered width minus 1 5/16"	Ordered width minus 1 1/16"
Bottom Rail Width:	Ordered width minus 1 5/16"	Ordered width minus 1 1/16"
Side and Exact Mount		
Bracket to Bracket Measurement:	Ordered width	Ordered width
End to End Roller Width:	Ordered width minus 1 1/16"	Ordered width minus 1 3/16"
Fabric Width:	Ordered width minus 1 1/8"	Ordered width minus 1 1/4"
Bottom Rail Width:	Ordered width minus 1 1/8"	Ordered width minus 1 1/4"

Color Lux® Roller Shade Head Rail Options

4" Fascia

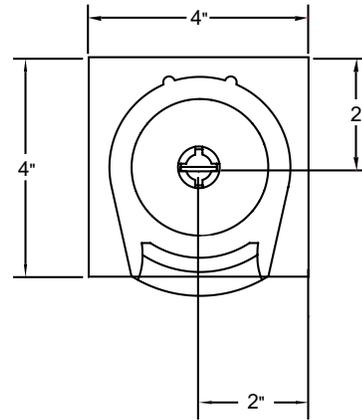
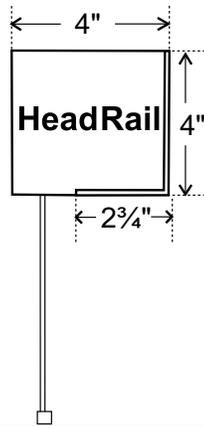

COLOR LUX® ROLLER SHADES

Hardware Features

Fascia Colors:	Black, Bronze, Brushed Aluminum, White and Vanilla
Roll Style:	Standard only
Bead Cord Style and Color:	White, black, bronze or steel bead chain
Bottom Rail Style:	Fabric Wrapped or Exposed Bottom Rail
Bottom Rail Color:	Fabric Wrapped: White, vanilla, bronze, black or brushed aluminum Exposed: White, vanilla, bronze, black or brushed aluminum
Motorization	Four Inch Fascia Hardware cannot be motorized.
Head Rail Surcharge	See price grids for surcharge information.

Mounting Dimensions

Minimum depth for flush inside mount including installation brackets: 4"
Minimum surface height required for outside mount: 4"

Four Inch Fascia Finished Dimensions	Standard Tube (1 1/2" diameter)	Oversized Tube (2" diameter)
Inside Mount		
Bracket to Bracket Measurement:	Ordered width minus 3/16"	Ordered width minus 3/16"
End to End Roller Width:	Ordered width minus 1 3/8"	Ordered width minus 1 3/8"
Fabric Width:	Ordered width minus 1 7/16"	Ordered width minus 1 7/16"
Bottom Rail Width:	Ordered width minus 1 7/16"	Ordered width minus 1 7/16"
Outside Mount		
Bracket to Bracket Measurement:	Ordered width plus 3/16"	Ordered width plus 3/16"
End to End Roller Width:	Ordered width minus 1"	Ordered width minus 1"
Fabric Width:	Ordered width minus 1 1/16"	Ordered width minus 1 1/16"
Bottom Rail Width:	Ordered width minus 1 1/16"	Ordered width minus 1 1/16"
Side and Exact Mount		
Bracket to Bracket Measurement:	Ordered width	Ordered width
End to End Roller Width:	Ordered width minus 1 3/16"	Ordered width minus 1 3/16"
Fabric Width:	Ordered width minus 1 1/4"	Ordered width minus 1 1/4"
Bottom Rail Width:	Ordered width minus 1 1/4"	Ordered width minus 1 1/4"

Color Lux® Roller Shade Head Rail Options

4" Skyline Fascia with Cord Loop and Simplicity Motorization

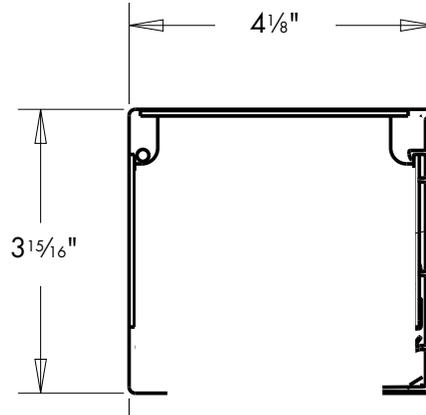

Hardware Features	
Fascia Colors:	White, Ivory, Black, Satin Nickel and Bronze
Roll Style:	Standard only
Bead Cord Style and Color:	White, Ivory, Black, Satin Nickel and Bronze
Skyline Clutch Colors:	White, Ivory, Black, Satin Nickel and Bronze
Bottom Rail Style:	Fabric Wrapped or Exposed Bottom Rail
Bottom Rail Color:	Fabric Wrapped: White, Black, Vanilla, Brushed Aluminum and Bronze Exposed: White, Black, Vanilla, Brushed Aluminum and Bronze
Tensioner Color:	White, Ivory, Black, Satin Nickel and Bronze
Motorization	4" Skyline Fascia can be motorized with Simplicity Motorization (non-rechargeable or rechargeable) or PowerTouch™ Rechargeable. See grids for pricing and pages 76 - 91 for details.
Head Rail Surcharge	See pages 59 and 60 for surcharge information.

Mounting Dimensions	
Minimum depth for flush inside mount including installation brackets: 4 1/8"	
Minimum surface height required for outside mount: 4"	
4" Inch Skyline Fascia cannot be installed as an inside mount with bracket covers. Bracket Covers are not provided for Inside Mount applications.	

Standard Roller Finished Dimensions	Standard Tube (1" and 1 1/2" diameter)	Oversized Tube (2" diameter)
Inside Mount		
Bracket to Bracket Measurement:	Ordered width	Ordered width
End to End Roller Width:	Ordered width minus 1"	Ordered width minus 1 1/16"
Fabric Width:	Ordered width minus 1 1/16"	Ordered width minus 1 1/8"
Bottom Rail Width:	Ordered width minus 1 1/16"	Ordered width minus 1 1/8"
Outside Mount and Exact Mount		
End Cap Cover to End Cap Cover:	Ordered width	Ordered width
Bracket to Bracket Measurement:	Ordered width minus 1/8"	Ordered width minus 1/8"
End to End Roller Width:	Ordered width minus 1 1/8"	Ordered width minus 1 3/16"
Fabric Width:	Ordered width minus 1 3/16"	Ordered width minus 1 1/4"
Bottom Rail Width:	Ordered width minus 1 3/16"	Ordered width minus 1 1/4"

Color Lux® Roller Shade Head Rail Options

Dual Roller Shades with Skyline Clutch and Simplicity Rechargeable Motorization

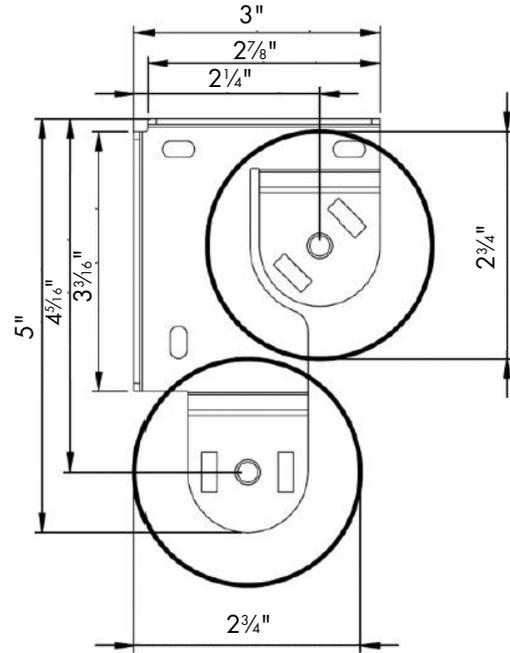

COLOR LUX® ROLLER SHADES

Hardware Features		
Roll Style:	Standard and reverse roll is required (reverse roll information is found on page 80)	
Bead Chain Color:	White, Ivory, Black, Satin Nickel and Bronze	
Clutch Color:	White, Ivory, Black, Satin Nickel and Bronze (Skyline Hardware Only)	
Bracket Cover Colors:	Bracket Covers are Not Available	
Bracket Colors:	White and Black	
Bottom Rail Style:	Fabric Wrapped or Exposed Bottom Rail	
Bottom Rail Color:	Fabric Wrapped: White, Black, Ivory, Brushed Aluminum and Bronze Exposed: White, Black, Ivory, Brushed Aluminum and Bronze	
Tensioner Colors:	White, Ivory, Black, Satin Nickel and Bronze	
Motorization	Standard Roller Hardware can be motorized with Simplicity Rechargeable Motorization (non-rechargeable not available.) PowerTouch Rechargeable is not available with Dual Roller Shades. See pages 59 and 60 for pricing and page 90 - 91 for details.	
Mounting Dimensions		
Minimum depth for flush inside mount including installation brackets: 3"		
Minimum depth required for side mounting: 1"		
Standard Roller Finished Dimensions	Standard Tube (1" and 1½" diameter)	Oversized Tube (2" diameter)
Inside Mount and Outside Mount		
Bracket to Bracket Measurement:	Ordered width	Ordered width
End to End Roller Width:	Ordered width minus 1"	Ordered width minus 1 1/16"
Fabric Width:	Ordered width minus 1 1/16"	Ordered width minus 1 1/8"
Bottom Rail Width:	Ordered width minus 1 1/16"	Ordered width minus 1 1/8"

NEW Color Lux® Highlights Cornice Valance with Keystone



Highlight any element of your home décor with the Highlights Cornice Valance upgrade. This tailored, fabric wrapped 6-inch valance, available with seven returns sized from 1½" to 6", mounts over any product, either inside or outside the frame. The NEW KEYSTONE option now allows for all fabrics to cover widths up to 216". It's the perfect solution for our Panel Track system. Highlights Valance without a keystone can be added to your roller shade order or as a stand alone product. Highlights Valance orders with a keystone are a stand alone product only.

Width In Inches

	24	30	36	42	48	54	60	66	72	78	84	94	102	106	112	118	124	130	136	144	150	156	162	168	174	180	186	192	198	204	210	216
Highlights Cornice Valance (No Keystone)	76	84	92	99	108	113	119	125	130	135	141	150	Keystone is required after 94". See pricing below to add a keystone.																			
Highlights Cornice Valance (with Keystone)	102	110	118	125	134	139	145	151	156	161	167	176	189	195	202	209	216	224	232	240	247	254	262	270	278	286	295	304	340	348	360	368

Highlights Valance Specifications

Valance Width with NEW Keystone: Maximum valance width is 216" for all Color Lux Roller Fabrics.

- Fabric cannot be railroaded
- Seaming is not available.
- Multiple Keystones may be required for larger widths. (ex. 216" Highlights Valance will require TWO Keystones, each 72" wide).

Valance Height: 6"

Standard Return Sizes:

- Inside Mount: None
- Outside Mount ordered with shade: 4"
- Custom Stand Alone Valance: Seven sizes are available, see chart below.

Highlights Cornice Valance Upgrade can be ordered in three ways:

- Inside Mount WITH your shade
- Outside Mount WITH your shade
- Custom Stand Alone Valance with seven return sizes

Highlights Ordering and Measuring Instructions Inside Mount Valance WITH Your Shade

- Inside mount valances are made without returns.
- An inside mount Highlights Valance will come with its own set of mounting brackets. In most scenarios, the valance brackets must be installed separately from the shade.
- Measure the inside width at the top of the window where the valance is to be installed. Measure in multiple spots to ensure accuracy. If there are variances, supply the smallest measurement.
- Please Note: The finished dimension of your inside mount bracket will be 3/16" less than your ordered width (see Figure A). Example: An inside mount valance ordered at 36" wide will be made 35 13/16".
- Please Note: You will need up to 3 1/2" of mounting depth to ensure your valance is fully recessed and flush with your window opening.

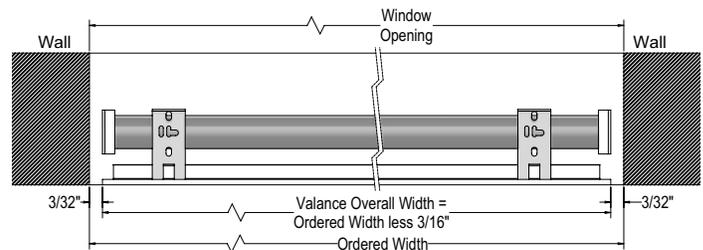

Figure A

Mounting Information with Stand Alone Highlight Valances with Returns Size Options

Style	Return Size	Mounting Depth Required	Inside Valance Depth Clearance Provided	Comments
Inside Mount	None	3" for flush	N/A	Mounted inside window opening
Shallow Mount	1 ½"	1 ½"	7/8"	Outside Mount valance with bracket mounted inside window opening
Shallow Mount	2"	1"	1 3/8"	Outside Mount valance with bracket mounted inside window opening
Shallow Mount	2 ½"	½"	1 7/8"	Outside Mount valance with bracket mounted inside window opening
Outside Mount	3"	½" surface height	2 3/8"	Valance will be mounted outside window opening
Outside Mount	4"	½" surface height	3 3/8"	Valance will be mounted outside window opening
Outside Mount	5"	½" surface height	4 3/8"	Valance will be mounted outside window opening
Outside Mount	6"	½" surface height	5 3/8"	Valance will be mounted outside window opening

Color Lux® Highlights Cornice Valance with Keystone

Highlights Ordering and Measuring Instructions

Outside Mount Valance WITH Your Shade

- Outside mount valance will have 4" returns.
- An outside mount Highlights Valance will come with its own set of mounting brackets. In most scenarios, the valance brackets must be installed separately from the shade.
- Measure the width of the area you wish to cover. Be sure to add extra space if you have window trim or extra wall space you'd like to cover.
- **Please Note:** When ordering outside mount valances, the finished overall width of your valance will be your ordered width plus 1 1/4" (see Figures B and C).
- **Example:** An outside mount valance ordered at 36" wide will be made 37 1/4".
- **Please Note:** You will need 1/2" of surface area to mount your valance (see Figure B).

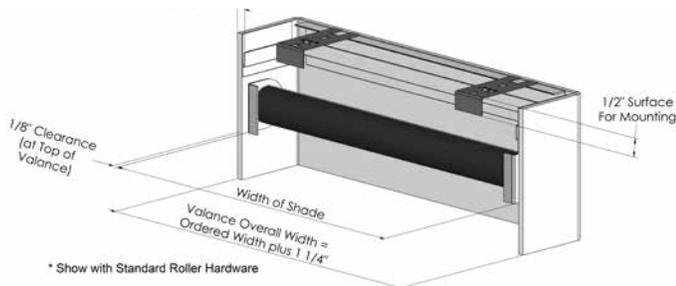

Figure B

Outside Mount

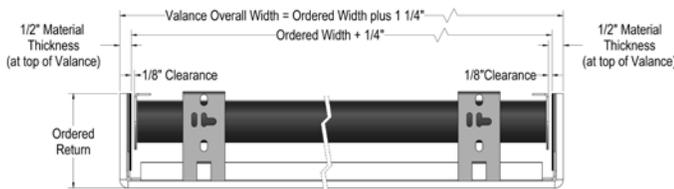

Figure C

Custom Stand Alone Valance with Return Size Options

- Measure the width of the area you wish to cover. Be sure to add extra space if you have window trim or extra wall space you'd like to cover. See Figures D-F for measuring information.
- Next, determine the length of your desired returns. Use the chart on page 77 for the mounting depth required and inside valance depth clearance provided for each return size.

Outside Mount

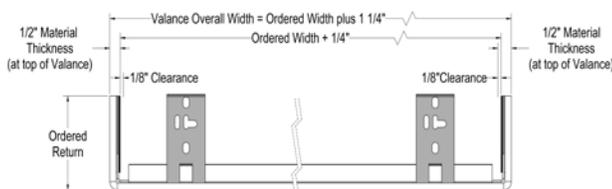

Figure D

Custom Stand Alone Valance with Return Size Options

(Cont.)

Inside Mount

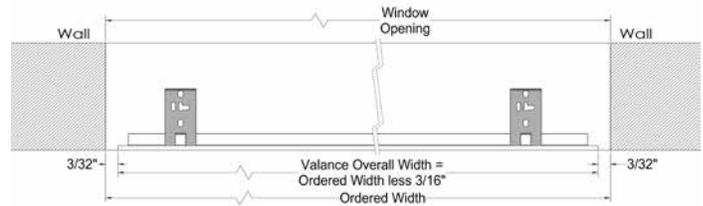

Figure E

Shallow Mount

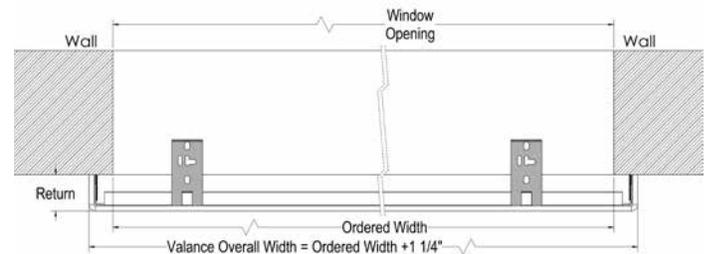
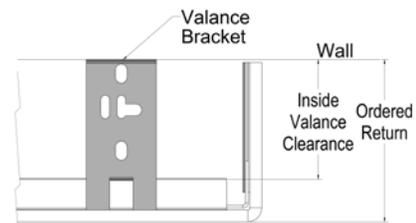

Figure F

Valance Returns

- Seven return size options are available when ordering a Highlights Valance as a stand alone product.
- **Return Sizes:** To determine a return length, add the component dimensions (mounting brackets, etc.) up to the wall. Subtract the measurements from any protrusions (molding, etc.), then choose from one of the pre-determined return applications (from the chart on page 77 that best fits your application).
- **Return Coverage**
Ordered return size refers to the distance from the face of the valance to the back of return. See Figure G.



Return dimensions are measured from the face of the valance to the wall.

Figure G

Clearances

Shallow Mount Bracket

- 1 1/2" Return provides an inside valance clearance of 1 7/8".
- 2" Return provides an inside valance clearance of 1 3/8".
- 2 1/2" Return provides an inside valance clearance of 1 7/8".

Outside Mount Bracket

- 3" Return provides an inside valance clearance of 2 3/8".
- 4" Return provides an inside valance clearance of 3 3/8".
- 5" Return provides an inside valance clearance of 4 3/8".
- 6" Return provides an inside valance clearance of 5 3/8".

COLOR LUX® ROLLER SHADES

Color Lux® Highlights Cornice Valance with Keystone

Keystone Specification

- All keystones will automatically be wrapped with matching Color Lux Roller Fabric.
- Available in Classic Duck, Linen and Solar Screen 5.
- Keystones will be provided separately and installed on site.
- Ordering two optional keystones is currently not available. Two keystones may be required for some wider width valances.
- Valance panels are divided in half when the Keystone option is ordered. Custom locations for keystone placement is not available.

Keystones for Panel Tracks

- Keystones ordered for Panel Tracks should use the return sizes list below to ensure clearance of the Panel Track Rail.
- **2 Panels Side or 4 Panel Split = minimum 3" returns**
- **3 Panels Side = minimum 3" returns**
- **4 Panels Side or 6 Panel Split = minimum 4" returns**
- **5 Panels Side or 8 Panel Split = minimum 4" returns**

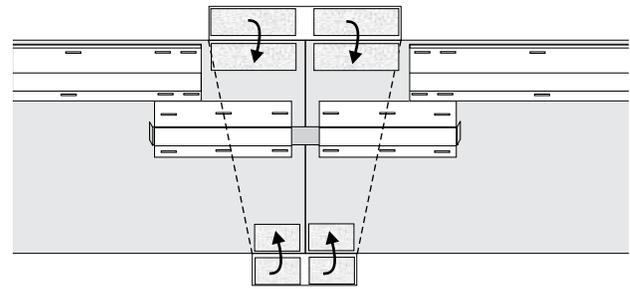

Rear view of the Highlights Valance Keystone. Not visible to room side.



Front view of the Highlights Valance Keystone.

Color Lux Custom Graphics for Highlights Cornice Valance.

Custom Graphics is available for Highlights Cornice Valance without a Keystone only.

- Available in Classic Duck Light Filtering, Classic Duck Blackout, and E - Screen 5%. (E Screen 5% is only available on Custom Graphics).
- Add 25% to Standard Rectangular Price on page 77.

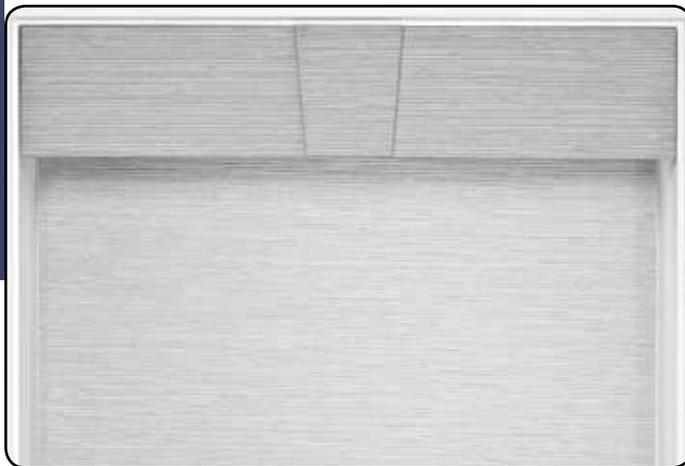

A Keystone option is available for all shade widths so every Highlights Valance in a room will be uniform

Color Lux® Roller Shade Head Rail Options

NEW Dual Roller Shades

Dual Roller Shades are available with Skyline Cord Loop and Simplicity Rechargeable Motorization. They are the perfect way to combine both light filtering and blackout fabrics into a single shade for the ultimate light control. Any fabric or screen in the Envision Fabric collection can be mixed and matched to create a versatile window for any time of day.

The front roll of fabric is always a reverse roll. The back roll of fabric is always a standard roll. Clutches are always on opposite sides of the shade to ensure a location for tensioner mounting.

Dual Roller Shades are not available with cordless operation or PowerTouch Rechargeable motorization. Bracket covers are not available. Brackets are available in black and white.

Candeling will occur between the upper and lower fabric rolls if a Blackout fabric is selected as the back roll. This allows that light to come through. Blackout fabric can be selected for the front roll to prevent this.

Simplicity Rechargeable Motorization is available with Dual Roller Shades to ensure easy installation without the need to mount two battery wands.

See price grids for Dual Roller Shade Specifications. Shade minimums and maximums are identical to single shade systems. Not available with 2" tube.



Candeling when Blackout Fabric is selected as the back roll.



Tensioners are mounted on opposite side of a Dual Roller Shade



Distance between rollers when front shade is raised all the way

DUAL ROLLER SHADE PRICING EXAMPLE:

For Satin Nickel Dual Roller Shades:	
Front Shade 36 x 60 Linen Light Filtering:	\$284
Back Shade 36 x 60 Linen Blackout:	\$315
Satin Nickel Skyline Clutch Surcharge: $\$27 \times 2 =$	\$54
Add Dual Roller Shade Surcharge:	\$27
TOTAL LIST PRICE BEFORE DEALER DISCOUNT =	\$680

COLOR LUX® ROLLER SHADES

Two-on-One Head Rail for Color Lux™ Roller Shades

Two on One Head Rail roller shades are two roller shades sharing the same head rail; each roller operates independently.

Operating Options

- Two on One Head Rail can be combined with cord loop, PowerTouch Motorization, Simplicity Motorization and Simplicity Rechargeable Motorization hardware options.
- Controls will always be placed to the far left and far right. (Controls are NOT available between two shades)

Fabric Options

- Two on One Head Rail roller shades are in both Classic Duck Light Filtering and Classic Duck Blackout for Color Lux Roller Shades
- See price grids for standard size limitations.



Head Rail Options

- Designer Cassette is REQUIRED for two on one roller shades.
- Two on One roller shades are ONLY available on 1½" tube.
- Available with Designer Cassette with Insert Strip and Smooth Face options.
- Fabric wrapping is NOT available on two on one Designer Cassette.
- Minimum single section is 12".
- Maximum single section is 106" for Classic Duck Light Filtering and Classic Duck Blackout fabrics
- Total maximum width in Designer Cassette head rail is 140". Maximum shade sizes will vary by fabric
- Center gap between roller shades is ¾".

TWO ON ONE CASSETTE PRICING EXAMPLE:

36" x 60" Classic Duck	
Blackout Fabric	\$284 x 2 = \$568.00
Designer Cassette Insert Strip	\$86 x 2 = \$172.00
PowerTouch Motorization:	\$99 x 2 = \$198.00

Total List Price Before Dealer Discount: \$938.00

- Specify shade total width and the two individual section widths. **Please Note:** The two individual sections must add up to the total width.

NEW Two-on-One No Head Rail Shades with Skyline Hardware

A NEW Two-on-One No Head Rail mounting option is available for shades using the Skyline system. An intermediate bracket is available that reduces the light gap when two shades are placed side-by-side.

Cord Loop shades will always have the clutch on the outside of both shades to ensure proper tensioner mounting.

Standard Brackets are available in White, Black, Ivory and Bronze. Intermediate Brackets are available in White, Black and Ivory.

Bracket covers for the two outer shades are the same colors available for a Skyline Standard Roller Shade: White, Black, Ivory, Bronze and Satin Nickel.

Two-on-One No Head Rail Shades are available with Cord Loop, Simplicity Motorization, Simplicity Rechargeable Motorization and PowerTouch Rechargeable shades.

PowerTouch Rechargeable wands will always hang to the outside of each Two-on-One No Head Rail shade.

TWO ON ONE NO CASSETTE PRICING EXAMPLE:

For Satin Nickel Two-on-One No Head Rail Shades with PowerTouch Rechargeable:

36 x 60 Linen Light Filtering Fabric:	\$284 x 2 = \$568
Add Satin Nickel Skyline:	\$27 x 2 = \$54
Add PowerTouch Rechargeable:	\$99 x 2 = \$198

Total List Price Before Dealer Discount = \$820

Cordless Operation for Color Lux™ Roller Shades

Cordless Roller Shades with Designer Cassette

Create a sleek look with the Designer Cassette Head Rail. Available in White, Ivory, Black, Satin Nickel and Bronze. See individual fabric specifications for minimum and maximum shade sizes. Cordless Roller Shades with Designer Cassette are available with the Smooth Face, Fabric Insert or Fabric Wrapped options.



Designer Cassette with Smooth Face in White



NEW Designer Cassette with Smooth Face in Ivory



Designer Cassette with Smooth Face in Black



Designer Cassette with Smooth Face in Oil Rubbed Bronze



NEW Designer Cassette with Smooth Face in Satin Nickel

Cordless Roller DecoBar

This cord-free system operates like a spring roller shade with a gentle tug on the bottom rail to raise and lower the shade. See page 69 for mounting information and finished dimension information. Reverse roll is available for the Deco-Bar Cordless option



White Cordless Roller Deco-Bar



Black Cordless Roller Deco-Bar



NEW Ivory Cordless Roller Deco-Bar



NEW Bronze Cordless Roller Deco-Bar



NEW Satin Nickel Cordless Roller Deco-Bar

NEW Cordless Roller Deco-Bar Bracket Covers

The Cordless Roller Decobar now offers deco bar covers in White, Ivory, Black, Satin Nickel and Bronze that coordinates with the deco-bar color selected. Available for Inside Mount or Outside Mount applications. Brackets are White and Black only.



Bracket cover provides a clean finished appearance

COLOR LUX® ROLLER SHADES

Cordless Operation for Color Lux™ Roller Shades

Cordless Tassels and Pulls

Add a decorative tassel or pull to help facilitate easy operation and keep the fabric on the bottom rail clean on all Cordless Shades. Tassels and pulls are placed in the middle of the bottom rail. They feature an approximately 3-inch long cord which coordinates with the tassel color.

Tassels and pulls are attached to the back of the bottom rail with a clear clip. This allows for in the field modifications if needed.

ALL Color Lux Roller Shade hardware is available with any Tassel or Pull.

Wood Ball Pulls

Add a decorative Wood Ball Pull to help facilitate easy operation and keep the fabric on the bottom rail clean on all Color Lux Roller Shades. Select from 4 colors: Waxed, Natural, Whitewash and Cocoa.

Add: \$17 Per Shade



Cocoa

Whitewash

Waxed

Natural

Beehive Pulls

Add a durable and fashionable Beehive Pull to your shades for easy lifting and lowering. These are a great combination with solar shades and are available in White and Onyx.

The Beehive pull is 2 5/8" long.

Add: \$40 Per Shade



Onyx

White

Wood Tassels

Select from 5 colors: Milky White, Ebony, Walnut, Light Pine or Mahogany.

A wood tassel is 1 5/16" long.

Add \$17 Per Shade



Clear Grip for Cordless Roller Shades

A clear grip comes included with all cordless roller shade orders with an option to attach the grip during installation. This easy to attach and easy to remove clear grip is a great way to keep the rail or the fabric (for fabric wrapped option) clean and new after regular shade use.

The width of the grip is 2 7/8".



Optional clear handle

Cord Loop Operation for Color Lux™ Roller Shades

Color Lux Roller Shades with Standard or Skyline Cord Loop Standard Cord Loop vs. Skyline Cord Loop

	Standard Roller System	Skyline Roller System
White Clutch	X	X
Black Clutch	X	X
Ivory Clutch		X
Bronze Clutch		X
Satin Nickel Clutch		X
White Bracket Covers	X	X
Black Bracket Covers	X	X
Ivory Bracket Covers		X
Bronze Bracket Covers		X
Satin Nickel Bracket Covers		X
Two-on-One No Head Rail		X
Side-By-Side Shades		X
Dual Roller Shades		X
3" Fascia	X	
4" Fascia	X	X
Metal Bead Chains (Steel and Bronze)	X	X

Color Lux Roller Shade Cord Loop Information

Color Lux Roller Shades are available with a choice of colored bead chain colors.

- Select white, black, bronze or steel bead chain with the Standard Roller, Fascia, and Designer Cassette head rail options.
- The bead chain will measure the length indicated below unless otherwise specified.

SHADE HEIGHT	LOOP DROP
12" to 15 ⁷ / ₈ "	² / ₃ of shade height
16" to 29 ⁷ / ₈ "	³ / ₄ of shade height
30" - 35 ⁷ / ₈ "	24" Loop
36" - 41 ⁷ / ₈ "	30" Loop
42" - 47 ⁷ / ₈ "	36" Loop
48" - 53 ⁷ / ₈ "	42" Loop
54" - 59 ⁷ / ₈ "	48" Loop
60" - 65 ⁷ / ₈ "	54" Loop
66" - 71 ⁷ / ₈ "	60" Loop
72" - 77 ⁷ / ₈ "	66" Loop
78" - 89 ⁷ / ₈ "	72" Loop
90" - 101 ⁷ / ₈ "	84" Loop
102" - 113 ⁷ / ₈ "	96" Loop
114" - above	³ / ₄ of shade height

- Bead chain can be ordered in custom lengths in 1 foot increments only. Maximum bead chain length is 15 feet.

Tensioners for Skyline Hardware Cord Loop Shades

Skyline Cord Loop Roller Shades feature a new tensioner design for easy mounting and smooth operation. Available in five finishes that matches the clutch control on Skyline Cord Loop roller shades, now every part of a Skyline Roller shade will coordinate from top to bottom.



White Tensioner



Black Tensioner



Satin Nickel Tensioner



Ivory Tensioner



Bronze Tensioner

COLOR LUX® ROLLER SHADES

Color Lux® Roller Shade General Information

Reverse Roll on Color Lux Roller Shades

A reverse roll option is available at no extra charge with all Color Lux Roller Shade fabrics only on the Standard Roller Hardware and Cordless Roller with Deco-Bar Hardware. The reverse roll allows the fabric to roll off the front of the roller instead of the back (the traditional style). The reverse roll conceals the roller for a contemporary, tailored appearance.



White Cordless Roller with Deco-Bar in Standard Roll



Black Cordless Roller with Deco-Bar in Standard Roll



White Cordless Roller with Deco-Bar in Reverse Roll



Black Cordless Roller with Deco-Bar in Reverse Roll



Standard Roller in Standard Roll



Standard Roller in Reverse Roll

Bottom Rail Options

Color Lux Roller Shades can be built with your choice of 2 bottom rail options:

- Fabric Wrapped Bottom Rail (standard)
- Exposed Bottom Rail

Choose your bottom rail color when ordering.

Fabric Wrapped Bottom Rail

The shade fabric is wrapped around an elliptical grooved rail. Two clear plastic end caps secure the fabric in place. Select from bronze, white, vanilla, black or brushed aluminum.

Choose your bottom rail color when ordering.



Fabric Wrapped Bottom Rail

Exposed Bottom Rail

Select from bronze, white, vanilla, black or brushed aluminum bottom rail to add a decorative accent to the bottom of your shade. Two clear plastic end caps secure the fabric in place.

Choose your bottom rail color when ordering.



Bronze Exposed Bottom Rail

NEW Color Lux™ PowerTouch™ Rechargeable for No Head Rail and Designer Cassette

Color Lux Roller Shades can be fabricated with the NEW PowerTouch™ Rechargeable option.

The PowerTouch™ Rechargeable provides an easy, cord free motorized operation for the budget savvy homeowner. PowerTouch™ Rechargeable uses Simplicity motors and components.



- PowerTouch™ Rechargeable is available for No Head Rail and Designer Cassette
- The No Head Rail option can use Skyline Hardware brackets and bracket covers available in White, Ivory, Black, Satin Nickel and Bronze. Wand and Pendant are always White or Black.

Color Lux Roller Shade PowerTouch™ Rechargeable Upgrade Surcharges

All standard discounts apply to PowerTouch™ Shades.

- PowerTouch™ Rechargeable Pendant and Wand: \$99.00
- Charger for PowerTouch™ Rechargeable (required): \$26.00

PowerTouch™ Rechargeable Roller Shade Specifications

See specific fabric price grids for minimum and maximum shade widths and lengths. Shade sizes in grey shaded sections are NOT available with the PowerTouch™ Rechargeable option.

PowerTouch™ Rechargeable Shades Operation

Press the up or down button on the pendant to raise or lower the shading to your desired position.

Programming the upper and lower limits is completed at the factory. These can be easily adjusted in the field if desired.

Programming the favorites position is completed after shade installation.

Please refer to the installation instructions at comfortexdealers.com.

PowerTouch™ Rechargeable Appearance

- The PowerTouch™ Rechargeable wand and pendant is attached to the head rail and requires no additional mounting.
- The No Head Rail PowerTouch™ Rechargeable wand must be attached to the motor before mounting.
- The wand and pendant hangs down the front of the shades
- The top and bottom buttons lift and lower the shade to the upper and lower limits. The center button is the favorites and stop button.
- The wand does not touch the fabric.
- Pendant is 2½" long.

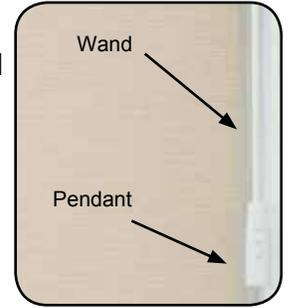

PowerTouch™ Rechargeable Color Options with Designer Cassette and No Head Rail Roller



White



Black

- Shades with Black or Oil Rubbed Bronze head rail will be built with black wand and pendants standard.
- Shades with White hardware will be built with white wand and pendants standard.
- Shades with Fabric Wrapped Head Rail will be built according to the head rail color selected.
- Shades booked as a no head rail roller will have a prompt to select wand color.

Wand and Pendant Location with Designer Cassette and No Head Rail Roller

The standard location for the wand and pendant is on the right. Please specify when ordering.

COLOR LUX® ROLLER SHADES

NEW Color Lux PowerTouch™ Rechargeable for No Head Rail and Designer Cassette

PowerTouch™ Rechargeable Wand Length with Designer Cassette and No Head Rail Roller

Shade Length	Standard Wand Length
Shades up to 30"	1' (12")
30" to 52"	2' (24")
52" to 78"	3' (36")
78" to 100"	4' (48")
100" to 120"	5' (60")

- Custom length wands are not available with PowerTouch™ Rechargeable. Standard wand lengths can be changed at no cost.

Mounting Requirements for PowerTouch™ Rechargeable Shades with Designer Cassette

- No special installation hardware or wiring requirements are needed to install PowerTouch™ Rechargeable Roller Shades with Designer Cassette Head Rail.
- A battery wand is not required with PowerTouch™ Rechargeable shades.

Mounting Requirements for PowerTouch™ Rechargeable Shades with No Head Rail Roller

- On No Head Rail roller shades, the wand must be attached to the motor with two screws (included) before mounting the shade.
- A battery wand is not required with PowerTouch™ Rechargeable shades.

PowerTouch™ Rechargeable Shades Do Not Have a Separate Battery Wand

There is no battery wand with the PowerTouch™ Rechargeable shades. The battery pack is integrated inside the roller tube to make mounting easier and more convenient.

The battery is recharged via the recharging port on the PowerTouch Rechargeable™ Wand.



Recharging Port

Battery Charger

8.4 Volt charger requires a standard power outlet to recharge the battery integrated within the motor. Must specify charger when ordering a PowerTouch Rechargeable shade. The charger plugs into the charger port. The charger is black and comes with a 156" wire.



PowerTouch™ Rechargeable Roller Shades Warranty

Please see page 103 for complete Comfortex warranty information.

Color Lux® Roller Shades with Simplicity Motorization



Color Lux Roller Shades can be motorized with Standard Simplicity Motorization. The Simplicity Motor program features an option for a battery wand or a DC plug in power supply. Simplicity motors are compact and use a radio controlled remote to raise or lower the shades.

Feature	
Remote Radio Frequency Operation	X
Upper and Lower Limit Stops Pre-Programmed	X
Battery Wand Standard (uses eight AA batteries)	X
Plug-in Transformer (DC Power Supply) Available	X
Intermediate ("Favorite") Position Programming	X

Head rail styles available with Standard Simplicity Motors:

- Standard Roller
- Standard Skyline Roller
- Designer Cassette
- 3" Fascia
- 4" Skyline Fascia

Standard Simplicity Motorized Upgrade and Surcharges

Standard Color Lux Discounts apply to motorized lift systems pricing.

Motor

- Radio Frequency Motor and Battery Wand: \$289.00

Hand Held Remote

- 5 Channel Remote: \$40.00
- **NEW** 6 Channel Timer Remote: \$65.00

DC Power Supply - Replaces Battery Wand

- Wall mount transformer DC12V/2A \$63.00

Battery Wand Extension Wires

- 48" Extension Wire \$18.00

The 5 Channel Simplicity Remote can operate up to five shades simultaneously, individually or in groups. **WHEN ORDERING PLEASE SPECIFY WHICH CHANNELS ARE ASSIGNED TO EACH SHADE OR GROUP OF SHADES.**

The 6 Channel Timer Remote can operate up to six shades simultaneously, individually or in groups and has a timer feature to create schedules for automatic shade operation. See page 89 for more information on the 6 Channel Timer Remote.

Steps to Pricing a Motorized Color Lux Roller Shade with Simplicity Motors

- Step 1** Price out Roller Shade at appropriate width and length with desired head rail.
 - Step 2** Add Motor Surcharge.
 - Step 3** Select Remote Surcharge.
 - Step 4** Add all line items for a grand total.
 - Step 5** Apply discount.
- Call Technical Services for assistance with motors.

Simplicity Motors Appearance

Standard Roller Hardware Appearance

Shade Features

- **Bottom rail style:** Fabric Wrapped or Exposed bottom rail
- **Bottom rail color:**
Fabric Wrapped: White, vanilla, bronze, black or brushed aluminum.
Exposed: White, vanilla, bronze, black or brushed aluminum.

The motor lead is 6" long and the battery wire is 10" long.



Standard Roller Idler End Standard Roller Motor End

Designer Cassette Head Rail Motor Appearance

This head rail is curved and conceals the shade fabric and motor mechanism with a smooth painted face, insert strip or fabric wrapped option.

Shade Features

- **Head Rail Color:** White, Black or Oil Rubbed Bronze with matching fabric strip or smooth face, and Fabric Wrap
- **Bottom Rail Style:** Fabric Wrapped or Exposed Bottom Rail
- **Bottom Rail Color:**
Fabric Wrapped: White, vanilla, bronze, black or brushed aluminum.
Exposed: White, vanilla, bronze, black or brushed aluminum.



The motor lead is 6" long and the battery wire is 10" long.

COLOR LUX® ROLLER SHADES

Color Lux® Roller Shades with Simplicity Motorization

Fascia Motor Appearance

This head rail is rectangular and conceals the shade fabric and motor mechanism with metallic or painted finish. Simplicity motors are available with 3" Fascias and 4" Skyline Fascia. See page 60 for 4" Skyline Fascia photography.



Shade Features

- **Head Rail Color:** Black, bronze, brushed aluminum, white or vanilla
- **Bottom Rail Style:** Fabric Wrapped or Exposed Bottom
- **Bottom Rail Color:**
Fabric Wrapped: White, vanilla, bronze, black or brushed aluminum.
Exposed: White, vanilla, bronze, black or brushed aluminum.

The motor lead is 6" long and the battery wire is 10" long.

Standard Roller, Designer Cassette and Fascia Specifications

See the price grids for motorized shades specifications on pages 61 - 65.

Mounting Requirements For Standard Simplicity Motorized Color Lux Roller Shades

Standard Roller Hardware

Battery Wand Mounting is Required. See page 67 for mounting information.

Standard Skyline Roller Hardware

Battery Wand Mounting is Required. See page 68 for mounting information.

Designer Cassette Hardware

Battery Wand Mounting is Required. See pages 70 - 72 for mounting information.

3" Fascia Hardware

Battery Wand Mounting is Required. See page 73 for mounting information.

4" Skyline Fascia Hardware

Battery Wand Mounting is Required. See page 75 for mounting information.

DC Power Supply

12 Volt DC power supply is available and requires a standard power outlet to power the motor. The transformer is an alternative to a battery wand. Each transformer can power a single shade with a Simplicity motor. The power supply must plug in to the motor. The DC power supply is white and comes with a 80" wire. The dimensions are 1 7/8" wide x 3 1/4" length x 1 1/4" deep.



Simplicity Motor Battery Wand Mounting

The battery wand is wall or ceiling mounted utilizing white battery wand clips. It also can be clipped to the Designer Cassette head rail.

Batteries are needed to operate Simplicity motors. The battery wand measures 17 1/4" and comes with eight alkaline batteries and is white in color.



Battery Wand

Simplicity Motor Battery Life and Replacement

Eight alkaline batteries are included with the wand.

The battery life will vary based on the type of window covering selected, the size and weight of the window covering and the number of times you operate the shade on a daily basis.

Comfortex will warranty batteries for up to 3 months from date of purchase. Batteries are not covered by the limited lifetime warranty.

Simplicity Motor Hand Held Remotes

The Simplicity Remote features 5 individual frequency channels and an All channel which will to operate all the shades at once. **WHEN ORDERING PLEASE SPECIFY WHICH CHANNELS ARE ASSIGNED TO EACH SHADE OR GROUP OF SHADES.** For example; program line 1 to channel 1, line 2 and 3 to channel 2, etc. If no channels are assigned at time of order, all shades will be programmed to Channel 1. To reprogram channel assignments, please refer to the installation instructions and/or view the video at comfortexdealers.com/products/motortechsupport.html.



The Simplicity remote is available in white or black. All remotes come with a holder which can be mounted to a wall for easy storage.

The remote controls utilizes one 3V battery (CR2430). Batteries are included. Comfortex will warranty batteries for up to 3 months from date of purchase. Batteries are not covered by the limited lifetime warranty.

See page 91 for more information about the Simplicity 6 Channel Timer Remote

Simplicity Battery Operated Motorized Shades Warranty

Please see page 103 for complete Comfortex warranty information.

Color Lux® Roller Shades with Simplicity Rechargeable Motorization

The Simplicity Rechargeable Motorization program features an integrated rechargeable lithium ion battery in the motor casing and is fully concealed by the roller tube.

Simplicity Rechargeable Motorization Upgrades and Surcharges

Motor	
• Radio Frequency Motor: Includes integrated rechargeable battery	\$289.00
Hand Held Remote	
• 5 Channel Remote:	\$40.00
• NEW 6 Channel Timer Remote:	\$65.00
Simplicity Rechargeable Motor Battery Charger	
• Charger for rechargeable motors (required):	\$26.00
NEW Simplicity Smart Controller	
• Smart Controller Unit	\$330.00
All standard discounts apply to motorized shadings.	

Simplicity Rechargeable Motorization

All Roller Shade Fabrics

Minimum Width: 18"
Maximum Width: See roller price grids for motorized shades specifications on pages 61 - 65.

Simplicity Rechargeable Motors Appearance with No Head Rail Roller and Designer Cassette Head Rail

The Simplicity Rechargeable motor and batteries are concealed within the roller tube.

Mounting Requirements

Standard Roller Hardware

No special installation hardware or wiring requirements are needed. See page 67 for mounting information.

Standard Skyline Roller Hardware

No special installation hardware or wiring requirements are needed. See page 68 for mounting information.

Designer Cassette Hardware

No special installation hardware or wiring requirements are needed. See page 70 - 72 for mounting information.

3" Fascia Hardware

Rechargeable Simplicity Motorization is not available for 3" fascia.

4" Skyline Fascia Hardware

No special installation hardware or wiring requirements are needed. See page 75 for mounting information

Simplicity Rechargeable Motor Batteries

The battery for the integrated rechargeable simplicity motor system is integrated within the motor casing and is fully concealed by the roller tube.

Rechargeable battery comes fully charged from the factory.

Battery Wand Mounting is Not Required

No external battery wand is required to operate an Color Lux Roller Shade with Simplicity Rechargeable Motorization.

Simplicity Rechargeable Motor Battery Life

Rechargeable battery is built into the motor.

The average battery charge will last 6-12 months based on an average sized shade raised and lowered once per day. The life of the battery charge will vary based on the type of window covering selected, the size and weight of the window covering and the number of times the shade is operated on a daily basis.

The battery can be recharged up to 500 times. It takes approximately 5 hours to recharge the motor when fully depleted.

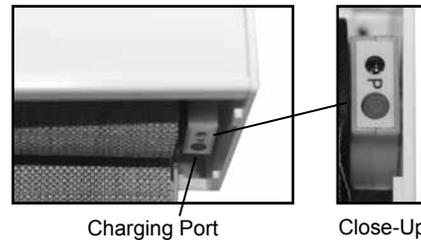

Battery Charger for Simplicity Rechargeable Motors

An 8.4 Volt charger requires a standard power outlet to recharge the battery. The charger must be specified when ordering a Rechargeable Simplicity Motorized shade. The charger plugs into the charging port of the motor.

The charger is black and comes with a 156" wire. The dimensions are 1" wide x 2½" length x 1¼" deep.



COLOR LUX® ROLLER SHADES

Color Lux® Roller Shades with Simplicity Rechargeable Motorization

Simplicity 6 Channel Timer Remote

The 6 Channel (6C) timer remote combines the functionality of a six channel hand-held control with the convenience of a programmable timer.

- The 6C timer remote allows for different scheduled actions each day of the week.
- Manual function disables the timer and the remote then operates as a 6-channel hand held remote.

Simplicity 6C remotes and holders are white in color. The remote comes with a holder which can be mounted to a wall for easy storage. The range of the remote is approximately 80 feet.



Important Information about Simplicity Rechargeable Motor Shade Operation and Installation

- Simplicity Motorized Shadings installed into windows with metal casings may have a reduced radio frequency range, or may not operate at all, depending on the application.
- Do not let the antenna on the motor touch any metal objects. This may interfere with signals from the remote control.
- Be mindful of when your shade starts to slow down during operation. It is a good indicator the shade needs to be recharged. The shade will also beep when the remote button is pressed.

THE FACTORY DOES NOT PROGRAM CHANNELS FOR SIMPLICITY RECHARGEABLE MOTORS.

The factory programs the upper and lower limits of every shade. Channel programming is completed after shade installation.

The Standard 5 Channel Simplicity Remote is also available for Simplicity Motorization. See page 89 for more information.

Please Note:

- Not all motors run at the same rate of speed.
- **REMOTES ARE NOT LINKED TO SHADES FROM THE FACTORY. SHADES MUST BE LINKED AFTER SHADE INSTALLATION.**
- Simplicity motors have a "Favorites" position setting. If the homeowner wants to set several shadings at the same intermediate position, follow instructions provided with installation manual.
- **WHEN ORDERING THE NEW SIMPLICITY RECHARGEABLE MOTORIZATION, PLEASE ORDER THE NECESSARY BATTERY CHARGER.**

Color Lux® Panel Track System



COLOR LUX
Designer Cellular & Roller Shades

Color Lux® Panel Track System

The Color Lux Panel Track Shade system offers versatility and a beautiful modern design for effective light control and outstanding performance. Panel track systems are a beautiful option for large windows and room dividers. The new system is available in Classic Duck and Linen Light Filtering and Blackout, and Solar Screen 5.

Stacking Options

Color Lux Panel Track Shades are available with 3 stacking configurations: split, left and right stacks.

- Split stack panels draw open to both sides equally. Controls may be placed on either side and is only available in cord control.
- Side stack is available as left or right stack and is available with a white wand or cord control.



Split Stack



Left or Right Stack



Closed Side Stack

Panel Attachment

A hook and loop strip is sewn onto every panel to provide a secure attachment. The patented panel attach method makes it easy to attach the panels even after installation of the rail.

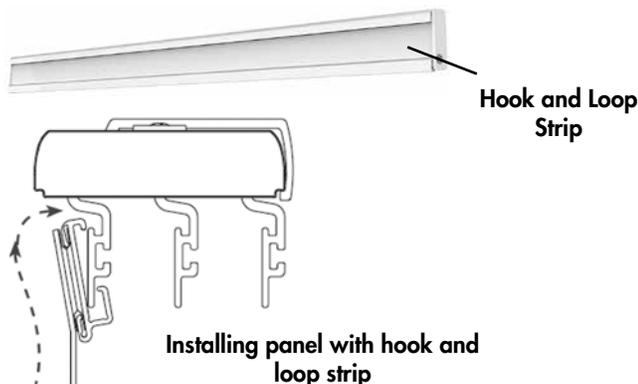

Head Rail Colors

Select from the white or aluminum system hardware system. (Wand is always white.)



White Head Rail



Aluminum Head Rail

Bottom Rail

The new panel track bottom rails are designed for smooth operation and allows all panels to glide smoothly past each other.

- Bottom rails are designed to match perfectly with the head rail in exposed white or silver.
- Finished bottom rails will be ½" higher than measured drop on inside mount shades.
- Bottom rails are not connected to each other on this panel track system.
- Fabric wrapped bottom rails are not currently available.



White Bottom Rail

Fabric Panels and Custom Overlaps

Classic Duck Light Filtering and Blackout are both available with the new Color Lux Panel Track Shade System.

- Panels will be fabricated with a 2" overlap as standard. Custom overlaps are available at 1½", 2½" and 3". Please specify when ordering.
- Panels are attached with a hook and loop strip to allow for subtle fabric adjustment in the field.
- Each panel traverses the track using ball bearings, creating smooth operation for wand and cord control
- Panels follow a single lead panel in sequence to open and close.
- Panels position exactly behind one another in the open position.
- There is no light gap between the rail and the panels.
- Panels will reach the end of the track.

Please Note: Panels may not hang perfectly flat immediately upon installation. Panels may have a billowing or wavy appearance at the time of installation which may correct itself over time.

Replacement panels are available.

Color Lux® Panel Track System

Control Options

The panel track system uses a cord or wand for traversing the fabric panels. Cord control is standard with every panel track shade. Wand control is available at no additional surcharge. Please specify when ordering.

Cord Control

- The nylon cord is white or grey to coordinate with hardware.
- Standard length of the cord is 10" less the ordered length. Custom cord lengths are available. Please specify when ordering.
- Standard cord placement is right stack with right cord.
- Operating cords are located on the outside edge of the panels.
- Tensioner for cord control is always white.
- Tensioner must always be placed so the cord reaches full extension.



Grey Cord Control

Wand Control

The traversing wand is a convenient alternative to a traditional cord control. This single control system protects children and pets from injuries caused by loop cords.



White Wand Control

- The wand control is always white.
- Only available on side stack systems.
- Standard wand placement is on the outside leading edge of the left or right stack.

Standard Wand Lengths

- Shades up to 72" in Length: 36" wand
- 72" to 96" in Length: 48" wand
- 96" to 120" in Length: 60" wand
- 120" to 144" in Length: 72" wand

Custom lengths are not available but you may select from one of the standard wand lengths above.

Panel Widths

To achieve the best performance on this panel track system, panels are designed within the following parameters:

- The minimum width for a single panel is 6".**
- The maximum width for a single panel is 48".**
- The maximum panel height is 144".**

See price grids for the minimum number of panels that will be available at the desired width.

More panels can be ordered at an additional surcharge and to achieve the desired panel width.

The standard panel overlap is 2". Custom overlaps are available.

Example: The standard split stack on a 96" wide opening would have 4 panels at 26" wide with a 2" overlap. If 6 panels are desired, each panel would be 18" wide.

Track Specifications

- The minimum width of a track is 18".**
- The maximum width of a track is 216".**

The maximum width of a single panel track is 216". When the total width is ordered over 100", tracks will be split in half and a connector bracket will be provided.

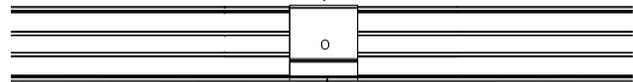

Panel Stack Back

The stack back will be equal to a single panel width. It will never be less than 12" and never exceed 48".

To determine an approximate stack back:

Ordered Width ÷ Number of Panels = Stack Back within +/- 2". (with 2" standard overlap)

Color Lux Custom Graphics for Panel Track

Custom Graphics is available on Panel Track Shades in the following fabrics:

- Classic Duck Light Filtering
- Classic Duck Blackout
- E Screen 5% (only available for Custom Graphics)

Add 25% to Standard Rectangular price plus desired upgrades.

COLOR LUX® PANEL TRACK SHADES

Color Lux® Panel Track Shades
Classic Duck Light Filtering **Linen Light Filtering** **Solar Screen 5**
Classic Duck Blackout **Linen Blackout**

GRID #22

Center Split Stack
Standard Cord Draw

Standard # of Panels	4 Panels	4 Panels	4 Panels	4 Panels	4 Panels	4 Panels	4 Panels	4 Panels	4 Panels	6 Panels	6 Panels
Panel Width	11"	14"	17"	20"	26"	32"	38"	44"	44"	34"	38"
	Width In Inches										
	36	48	60	72	96	120	144	168	192	216	
48	643	739	783	879	1077	1228	1427	1568	1670	1767	
60	659	758	803	902	1105	1260	1466	1610	1714	1814	
72	674	777	820	924	1133	1290	1503	1651	1758	1861	
84	689	795	839	945	1161	1322	1541	1691	1803	1907	
96	705	814	858	967	1189	1355	1580	1734	1847	1954	
108	720	834	877	989	1217	1386	1616	1774	1892	2001	
120	736	851	895	1012	1246	1418	1655	1816	1937	2047	
132	752	871	947	1034	1274	1484	1693	1892	2016	2131	
144	767	889	970	1055	1303	1519	1732	1937	2064	2182	

Surcharge for Additional Panels

6 Panels	—	—	31	42	54	67	79	91	—	—
8 Panels	—	—	—	—	108	134	158	182	110	124

Panel Width (Inches) (Approximate*)

6 Panels	—	—	10"	12"	16"	20"	24"	28"	—	—
8 Panels	—	—	—	—	12"	15"	18"	21"	24"	27"

* Measurements do not account for standard deductions to fabric and head rail and use standard 2" overlap.

GRID #23 One Way Side Stack
Standard Cord Draw

Standard # of Panels	2 Panels	2 Panels	2 Panels	2 Panels	3 Panels	3 Panels	4 Panels	4 Panels	5 Panels	5 Panels
Panel Width	20"	26"	32"	38"	34"	42"	38"	44"	40"	43"
	Width In Inches									
	36	48	60	72	96	120	144	168	192	216
48	643	739	783	879	1077	1228	1427	1568	1670	1767
60	659	758	803	902	1105	1260	1466	1610	1714	1814
72	674	777	820	924	1133	1290	1503	1651	1758	1861
84	689	795	839	945	1161	1322	1541	1691	1803	1907
96	705	814	858	967	1189	1355	1580	1734	1847	1954
108	720	834	877	989	1217	1386	1616	1774	1892	2001
120	736	851	895	1012	1246	1418	1655	1816	1937	2047
132	752	871	947	1034	1274	1484	1693	1892	2016	2131
144	767	889	970	1055	1303	1519	1732	1937	2064	2182

Surcharge for Additional Panels

3 Panels	22	28	37	42	—	—	—	—	—	—
4 Panels	—	56	74	84	108	68	—	—	—	—
5 Panels	—	—	148	168	216	136	166	101	—	—

Panel Width (Inches) (Approximate*)

3 Panels	12"	16"	20"	24"	—	—	—	—	—	—
4 Panels	—	12"	15"	18"	24"	30"	—	—	—	—
5 Panels	—	—	12"	14"	19"	26"	29"	34"	—	—

* Measurements do not account for standard deductions to fabric and head rail and use standard 2" overlap.

Additional Surcharges

Scotchgard™ Stain Protection	Add \$50 to the standard rectangular price.
-------------------------------------	---

Product Specifications

Head Rail Options

- White
- Aluminum

Bottom Rail Options

- White
- Aluminum

Control Options

- Cord Draw (standard)
- Wand Draw (wand is always white)

Panel Size

- Minimum panel width is 6"
- Maximum panel width is 48"

Color Lux® Panel Track System Specifications

Panel Track Finished Dimensions				
	Inside Mount - Cord Draw	Inside Mount - Wand Draw	Outside Mount - Cord Draw	Outside Mount - Wand Draw
Width of Finished Panel Coverage	Ordered Width minus 5/8"	Ordered Width minus 5/8"	Ordered Width minus 3/8"	Ordered Width minus 3/8"
Track	Ordered Width minus 1/4"	Ordered Width minus 1/4"	Ordered Width	Ordered Width
Length	Ordered Length minus 1/2"	Ordered Length minus 1/2"	Ordered Length	Ordered Length

Mounting Options

The following mounting options are available. All mounting brackets are coordinated with the head rail in white or aluminum:

- Wall Bracket with End Caps
- Ceiling Bracket with End Caps

Light Gap

Head Rail/Fabric Panels: There is no light gap between the fabric panels and the bottom of the head rail.

Outside Mount Bracket/Head Rail: There is a 1/4" light gap between the top of the track to the top of the outside mount installation bracket.

Inside Mount Bracket/Head Rail: There is a 1/8" gap between the top of the track to the top of the inside mount installation bracket.

Bottom Light Gap: There will be a 1/2" light gap at the bottom of the hanging panels on an inside mount shade.

Side Light Gap: There will be 3/16" side light gap at the sides of the panel track.

To avoid side light gap on outside mount shades, Comfortex recommends increasing the ordered width by 5", or 2 1/2" on both sides.

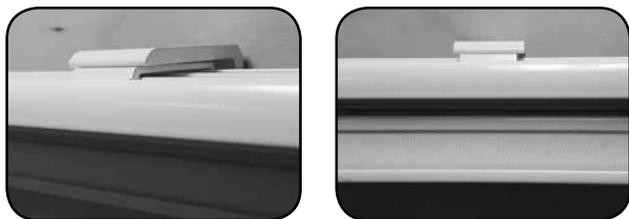

Outside Mount Installation Bracket Appearance

Fabric Deductions and Specifications

Panels are fabricated with a 2" overlap as standard. Custom overlaps are available in 1 1/2", 2 1/2" or 3".

Inside Mount:

Head rail width = ordered width minus 1/4"

Panel height allowance = ordered length minus 1/2"

Outside Mount:

No additional deductions are taken for fabric width

Panel height allowance = ordered length

NEW Highlights Valance for Panel Track with Keystone

See pages 77 - 79 for more information on the Color Lux Highlights Cornice Valance for your Panel Track system.

- Keystones ordered for Panel Tracks should use return sizes list below to ensure clearance of the Panel Track Rail.
- **2 Panels Side or 4 Panel Split = minimum 3" returns**
- **3 Panels Side = minimum 3" returns**
- **4 Panels Side or 6 Panel Split = minimum 4" returns**
- **5 Panels Side or 8 Panel Split = minimum 4" returns**
- Keystones automatically match the color and fabric of the ordered Color Lux Highlights Valance. Custom color options are not available.
- Valance panels are divided in half when the Keystone option is ordered. Custom locations for keystone placement is not available.
- Ordering two optional keystones is currently not available.
- Multiple Keystones may be required for larger widths. (ex. A Highlights Valance with an ordered width of 216" will require TWO Keystone. All three valances will be 72" wide, excluding returns).

Highlights Cornice Valance with Keystone for Panel Track Shades

	24	30	36	42	48	54	60	66	72	78	84	94	102	106	112	118	124	130	136	144	150	156	162	168	174	180	186	192	198	204	210	216
Highlights Cornice Valance (No Keystone)	76	84	92	99	108	113	119	125	130	135	141	150	Keystone is required after 94". See pricing below to add a keystone.																			
Highlights Cornice Valance (with Keystone)	102	110	118	125	134	139	145	151	156	161	167	176	189	195	202	209	216	224	232	240	247	254	262	270	278	286	295	304	340	348	360	368

COLOR LUX® PANEL TRACK SHADES

Color Lux® Panel Track System Specifications

Outside Mount Hardware Profiles

Five separate panel track profiles are available depending on the number of panels ordered.

Two Track System

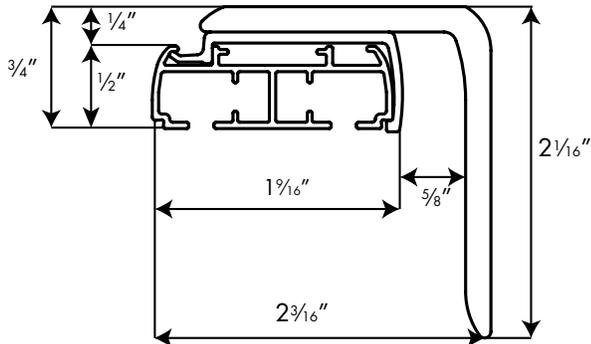

Two channel tracks are used for:
 2 panel side stack
 4 panel split stack

Mounting Dimensions

Minimum height required for outside mounting: 2 1/16"

Extension Bracket projects back of bracket 2 5/8" from wall

Three Track System

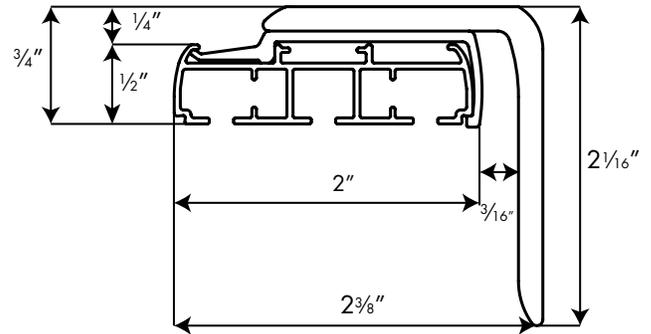

Three channel tracks are used for:
 3 panel side stack
 Not Available for split stack

Mounting Dimensions

Minimum height required for outside mounting: 2 1/16"

Extension Bracket projects back of bracket 2 3/16" from wall

Four Track System

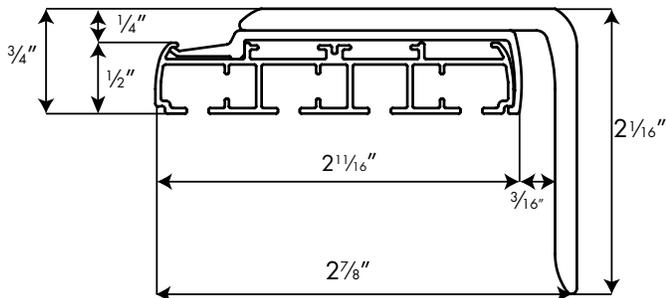

Four channel tracks are used for:
 4 panel side stack
 6 panel split stack

Mounting Dimensions

Minimum height required for outside mounting: 2 1/16"

Extension Bracket projects back of bracket 1 1/16" from wall

Five Track System

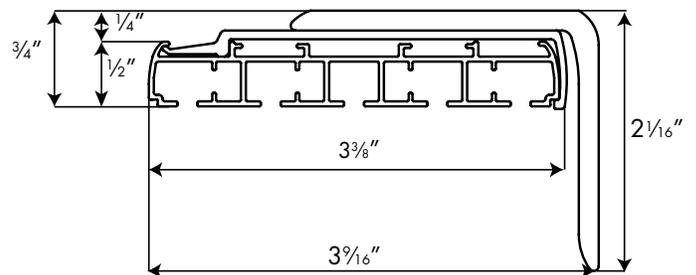

Five channel tracks are used for:
 5 panel side stack
 8 panel split stack

Mounting Dimensions

Minimum height required for outside mounting: 2 1/16"

Extension Bracket projects back of bracket 1 7/16" from wall

Color Lux® Panel Track System Specifications

Inside Mount Hardware Profiles

Five separate panel track profiles are available depending on the number of panels ordered.

Two Track System

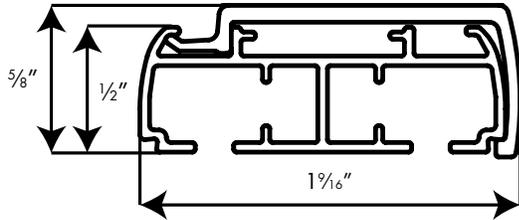

Two channel tracks are used for:
 2 panel side stack
 4 panel split stack

Mounting Dimensions

Minimum depth for flush inside mount: 1 1/16"
Minimum depth required for shallow mounting: 1 1/4"

Three Track System

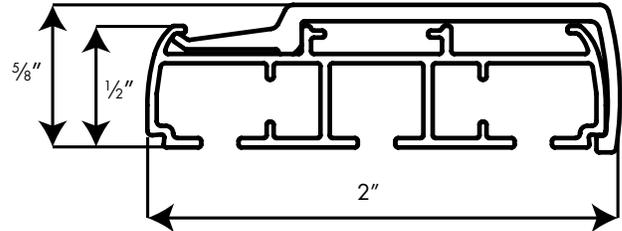

Three channel tracks are used for:
 3 panel side stack
 Not available for split stack

Mounting Dimensions

Minimum depth for flush inside mount: 2"
Minimum depth required for shallow mounting: 1 7/16"

Four Track System

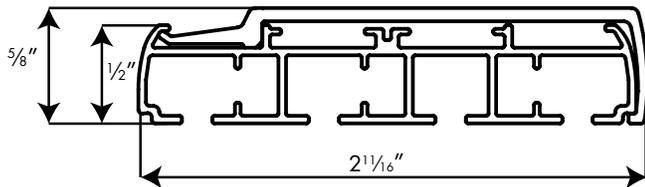

Four channel tracks are used for:
 4 panel side stack
 6 panel split stack

Mounting Dimensions

Minimum depth for flush inside mount: 2 1/16"
Minimum depth required for shallow mounting: 2 1/16"

Five Track System

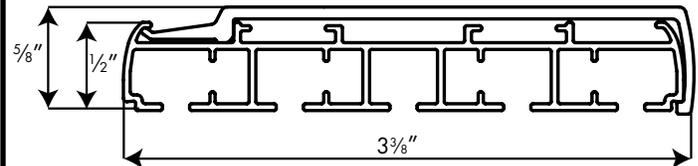

Five channel tracks are used for:
 5 panel side stack
 8 panel split stack

Mounting Dimensions

Minimum depth for flush inside mount: 3 3/8"
Minimum depth required for shallow mounting: 2 1/4"

Spacer blocks are available at 1/16" increments, up to two. Add to overall projection.
 Example: For a four panel track, take 2 3/8" plus 1/16"

COLOR LUX® PANEL TRACK SHADES

COLOR LUX®

Custom Graphics



Color Lux® Custom Graphics

Print Photos, Logos, Artwork, Advertisements and More on Color Lux® Roller and Panel Track Shades!

With Color Lux® Custom Graphics you can print literally anything on a Color Lux® Roller or Panel Track Shade. From logos and advertisements for a store front, to personal photos and theme room graphics, virtually anything you imagine can be featured on a Color Lux® Roller or Panel Track Shade.

Color Lux® Custom Graphics are also available on Cellular Shades. See the Cellular and Pleated Price Guide for more information.



Side A

Shows Printed Image

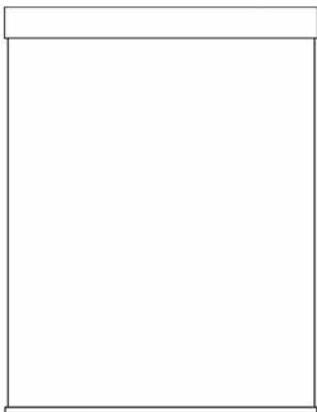

Side B

White Fabric

Single Sided Printing:

- Select a Roller or Panel Track Shade.
- Color Lux® Roller Custom Graphics Shades are available on Classic Duck Light Filtering, Classic Duck Blackout and Mermet E Screen 5% (E Screen 5% is only available with Custom Graphic Shades)
- Use the Color Lux Custom Graphics Grids on pages 102 and 103.
- A Color Lux® solid color may be selected for the background color of your shade.
- You can choose to have Side A face the room side or the street side.
- Use the Color Lux® Custom Graphics Order Form

Please Note: When ordering a Color Lux® Panel Track System Shade with a custom graphic, the custom graphic will not line up. The fabric used on Color Lux® Panel Track Shades will be printed at the total width and length specified for the complete system and then will be cut into the number of panels specified. **The pattern on the adjacent panels will overlap by 1/2”.**



Side A

Shows Printed Image

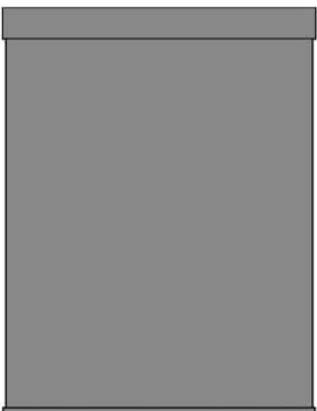

Side B

Solid Printed Color ONLY
(No Graphics)

Double Sided Printing -

Roller Shades on Mermet E Screen 5% Only:

- Double sided printing is available only with Roller Shades.
- Double sided printing is only available on Mermet E Screen 5% Fabric.
- Add the 40% Surcharge to the Standard Rectangular price plus desired hardware options.
- Side A can be any custom graphic.
- Side B can only be a Color Lux® solid color (NO GRAPHICS).
- You can choose to have Side A face the room side or the street side.
- A Color Lux® solid color may be selected for the background color of your shade.
- Use the Color Lux® Custom Graphics Roller Shade Order Forms.

Ordering Color Lux® Custom Graphics Shades

How to order Color Lux® Custom Graphic Shades

STEP 1. FAX OR E-MAIL YOUR ORDER

Fax the appropriate Color Lux® Custom Graphics order form (Roller, Panel Track or Cellular) located on comfortexdealers.com to (800) 336-4580. Or e-mail the order form to customercare@comfortex.com. Upon receipt and review of your order, you will receive a work order confirmation number from Comfortex. Please be sure to reference this number when submitting your artwork in Step 2.

STEP 2. SOURCE AND SEND YOUR GRAPHIC

Source your graphic from a stock photo site such as www.istockphoto.com or use your own high resolution photography. Send your files via e-mail to: customgraphics@comfortex.com OR ship a CD/portable media containing your graphics to:

Color Lux® Custom Graphics
 Comfortex Window Fashions
 21 Elm Street
 Maplewood, New York 12189

Using Online Stock Agencies for Graphics for Your Shades

Sometimes, finding the right graphic or photograph to fit your shade size, shape, or content can be challenging. Fortunately, many web sites offer a great solution. Online stock agencies allow you to purchase reasonably priced, royalty-free digital illustrations, graphics, photographs, patterns, and more in thousands of different subject areas. Some of the more popular sites include:

- thinkstock.com
- istockphoto.com
- veer.com
- shutterstock.com
- gettyimages.com
- 123rf.com
- photosearch.com

Using these sites is easy, simply follow these steps:

Step 1. Create an account and search for your image (i.e. apples).

Step 2. Select, purchase, and download the image you like. You may be given a choice of sizes, so take care to select an option large enough for your needs. Be sure to include the Work Order Confirmation Number received from Comfortex Customer Service with your graphic files.

STEP 3. APPROVE YOUR PROOF

The Color Lux® Custom Graphic Team will email a PDF proof of your shade order which must be reviewed and approved for production to begin. Once the artwork is approved, it will take 2 weeks for your order to be printed, assembled, and shipped.

Color Lux® Graphic File Specifications

Preferred Formats

- Vector files/Adobe Illustrator (AI or EPS)
Please convert all typography to paths prior to submitting your vector artwork.
- TIFF, JPG/JPEG, or Adobe Photoshop (PSD) files with a minimum resolution of 100 pixels per inch at 100% size. For example, a shade measuring 30" x 40" should be supported by a graphic measuring at least 3000 x 4000 pixels.
- Adobe Acrobat (PDF) files created in "Press Quality" or "High Quality Print" with a minimum resolution for all raster elements of 100 pixels per inch at 100% size.

Graphics optimized for, or harvested from the internet are, in general, not suitable for reproduction onto shades.

Comfortex will seek to verify ownership and rights to reprint for all images showcasing copyrighted material.

Questions? Please contact Comfortex Customer Care with all questions regarding Color Lux® Custom Graphic Orders.

E Screen 5% Fabric Properties

Mermet E Screen 5%	TS	RS	AS	TV	OF	SHGC/G Value		Fire Rating	Bacterial & Fungal Resistance	Acoustical Properties	RoHS
						CL - S	DG				
Composition: 36% Fiberglass, 64% Vinyl Width: 98" Weight: 363 g/m ² ± 5% Thickness: 0.41 mm ± 5% UV Blockage: 90%	20	71	9	17	5.00	0.32	0.34	NFPA 701-10 TM#1, California U.S. Title 19	ASTM E2180 ASTM G21	NRC: 0.10 SAA: .012	v

**Color Lux Custom Graphics
Standard Roller Shade**

Classic Duck Light Filtering

COLOR LUX® CUSTOM GRAPHICS

		Width In Inches																				
		24	30	36	42	48	54	60	66	72	78	84	90	96	102	106	112	118	124	130	136	144
Length In Inches	36	236	263	291	323	359	398	443	499	554	615	699	770	830	896	968	990	1179	1285	1404	1534	1673
	42	243	269	299	333	369	409	454	513	569	631	718	790	853	921	994	1014	1210	1319	1444	1574	1720
	48	249	276	308	341	379	421	466	525	584	648	736	810	875	945	1021	1041	1243	1355	1480	1616	1764
	54	258	283	314	349	388	430	479	539	599	664	756	830	899	970	1048	1069	1274	1390	1516	1656	1810
	60	263	291	323	358	398	441	490	554	615	681	774	851	919	993	1071	1093	1305	1424	1556	1698	1854
	66	269	298	331	368	408	453	503	565	629	698	793	873	941	1018	1099	1121	1338	1459	1593	1740	1899
	72	275	306	339	378	418	463	514	580	644	714	813	893	965	1041	1126	1148	1369	1495	1630	1781	1946
	78	281	311	348	384	426	473	525	594	658	731	830	913	986	1066	1150	1175	1401	1529	1669	1824	2506
	84	288	319	354	393	436	485	539	605	674	746	850	935	1010	1090	1176	1200	1431	1564	1706	1861	3226
	90	295	326	363	403	446	495	549	620	689	764	868	955	1031	1134	1215	1228	1464	1599	1745	1905	4154
	96	301	334	370	413	456	505	560	634	701	780	888	978	1055	1183	1244	1254	1496	1633	1783	2453	5348
	102	308	341	378	419	465	518	574	648	719	796	906	996	1076	1214	1269	1634	1926	2102	2295	3158	6885
	108	313	348	386	428	476	528	585	660	734	814	925	1018	1099	1219	1310	1687	2480	2706	2955	4066	8865
	114	319	354	393	436	485	539	598	674	749	830	945	1038	1123	1249	1348						
	120	326	363	403	446	495	549	609	688	764	846	963	1059	1144	1269	1399						
126	333	369	410	456	504	560	620	700	779	864	981	1080	1169	1298	1418							
132	341	378	419	465	515	573	634	715	794	881	1001	1101	1191	1324	1496							
138	348	384	426	474	525	584	646	730	810	899	1021	1124	1215	1344	1523							
144	354	391	434	484	535	595	659	744	826	915	1041	1146	1241	1398	1571							

Classic Duck Light Filtering: Minimum standard shade size is 12" x 12". Maximum shade width is 106" and it can be railroaded to a maximum width of 144" and a maximum length of 108". Double sided printing is not available.

**Color Lux Custom Graphics
Standard Roller Shade**

Classic Duck Blackout

		Width In Inches																				
		24	30	36	42	48	54	60	66	72	78	84	90	96	102	106	112	118	124	130	136	144
Length In Inches	36	260	289	320	355	395	438	486	549	609	676	769	848	913	986	1064	1088	1296	1415	1545	1688	1840
	42	266	296	329	366	406	450	499	564	626	695	789	869	938	1014	1094	1116	1331	1451	1589	1730	1893
	48	274	304	339	375	416	464	513	578	643	713	810	891	963	1040	1124	1145	1365	1491	1628	1778	1941
	54	284	311	345	384	426	473	526	593	659	730	833	913	989	1068	1153	1178	1401	1529	1669	1823	1999
	60	289	320	355	394	438	485	539	609	676	750	851	936	1011	1091	1179	1203	1435	1566	1711	1868	2059
	66	296	328	365	404	449	498	553	621	691	768	871	960	1035	1119	1209	1234	1473	1605	1751	1915	2121
	72	303	338	373	415	459	509	565	638	709	785	894	981	1061	1145	1239	1261	1505	1644	1793	1972	2185
	78	310	343	383	423	469	520	578	654	724	805	913	1004	1085	1173	1265	1293	1541	1683	1836	2032	2250
	84	316	351	389	431	480	534	593	665	741	821	935	1029	1111	1199	1294	1321	1575	1720	1891	2093	2318
	90	325	359	399	443	491	545	604	683	758	840	954	1050	1135	1248	1336	1350	1611	1759	1948	2155	2387
	96	331	368	408	454	503	555	616	698	771	858	976	1075	1160	1301	1369	1379	1646	1796	2007	2220	2459
	102	339	375	415	461	511	569	631	713	791	876	998	1096	1184	1335	1396	1775	1696	1850	2067	2287	2533
	108	344	383	425	470	524	580	644	726	808	895	1018	1119	1209	1341	1441	2285	1747	1906	2129	2355	2609
	114	351	389	431	480	534	593	658	741	824	913	1040	1141	1235	1374	1483						
	120	359	399	443	491	545	604	670	756	840	931	1059	1165	1259	1396	1539						
126	366	406	451	503	554	616	683	770	856	950	1080	1188	1286	1428	1559							
132	375	415	461	511	566	630	698	786	874	970	1101	1211	1310	1456	1646							
138	383	423	469	521	578	643	711	803	891	989	1124	1236	1336	1479	1675							
144	389	430	478	533	589	655	725	819	909	1006	1145	1261	1365	1538	1729							

Classic Duck Blackout: Minimum standard shade size is 12" x 12". Maximum shade width is 106" and it can be railroaded to a maximum width of 144" and a maximum length of 108". Double sided printing is not available.

Color Lux Custom Graphics for Panel Track Shades

Available on Classic Duck Light Filtering, Classic Duck Blackout, and E-Screen 5% (E - Screen is only available with Custom Graphics shades) See page 95 for price grids. Add 25% to Standard Rectangular price plus desired upgrades.

Color Lux Custom Graphics for Highlights Valance

Not available with the Keystone Option. Available on Classic Duck Light Filtering, Classic Duck Blackout, and E-Screen 5% (E - Screen is only available with Custom Graphics shades). See page 77 for price grids. Add 25% to Standard Rectangular price.

Color Lux Custom Graphics
Standard Roller Shade

E Screen 5%

COLOR LUX® CUSTOM GRAPHICS

		Width In Inches																				
		24	30	36	42	48	54	60	66	72	78	84	90	96	102	108	112	118	124	130	136	144
Length In Inches	36	289	320	355	394	439	486	540	609	676	751	854	941	1013	1095	1181	1208	1439	1571	1715	1874	2043
	42	295	329	365	406	451	500	554	626	695	771	875	964	1041	1125	1214	1239	1478	1611	1764	1920	2101
	48	304	338	376	416	463	515	569	641	714	791	899	989	1069	1155	1248	1271	1515	1655	1806	1973	2155
	54	315	345	383	426	474	525	584	658	731	810	924	1013	1098	1185	1279	1308	1555	1698	1853	2023	2220
	60	320	355	394	438	486	539	598	676	751	833	945	1039	1123	1211	1309	1335	1593	1739	1900	2073	2286
	66	329	364	405	449	498	553	614	690	768	853	968	1065	1149	1241	1341	1370	1635	1781	1944	2135	2355
	72	336	375	414	461	509	565	628	708	786	871	993	1089	1178	1271	1375	1400	1670	1825	1990	2199	2425
	78	344	380	425	469	520	578	641	726	804	894	1013	1114	1204	1301	1404	1435	1711	1868	2050	2265	2498
	84	351	390	431	479	533	593	658	739	823	911	1038	1143	1234	1330	1436	1466	1749	1909	2111	2333	2573
	90	361	399	443	491	545	605	670	758	841	933	1059	1165	1260	1385	1484	1499	1789	1966	2175	2403	2650
	96	368	408	453	504	558	616	684	774	856	951	1084	1194	1288	1445	1519	1530	1828	2025	2240	2475	2730
	102	376	416	461	513	568	631	701	791	879	973	1108	1216	1314	1481	1550	1576	1882	2086	2307	2549	2812
	108	381	425	471	521	581	644	715	806	896	994	1130	1241	1341	1489	1600	1623	1939	2148	2376	2625	2896
	114	390	431	479	533	593	658	730	823	914	1013	1155	1266	1371	1525	1645						
120	399	443	491	545	605	670	744	840	933	1034	1175	1294	1398	1550	1708							
126	406	451	501	558	615	684	758	855	950	1055	1199	1319	1428	1585	1730							
132	416	461	513	568	629	699	774	873	970	1076	1223	1345	1454	1616	1664							
138	425	469	520	579	641	714	790	891	989	1098	1248	1373	1484	1641	1690							
144	431	478	530	591	654	728	805	909	1009	1118	1271	1400	1515	1706								

Mermet 5% E Screen: Minimum standard shade size is 12" x 12". Maximum shade width is 120" and can be railroaded to a maximum width of 144" with a maximum length of 108". Mermet 5% E Screen is only available for Color Lux Custom Graphics shades. Double Sided printing is only available on Mermet 5% E Screen.

Head Rail Options and Surcharges

Section 1 & 2	Available: Designer Cassette (All), Cordless Deco-Bar, Fascia (All), Motorization, PowerTouch Rechargeable, Standard Roller, and All Skyline Hardware
Section 3	Available: Standard Roller, Standard Skyline Roller, 4" Fascia, and 4" Skyline Fascia with Cord Loop (Dual Roller Not Available)
Section 4	Available: Standard Skyline Roller Only (Dual Roller Not Available)

See pages 59 and 60 for Skyline Hardware Options.

Designer Cassette	24	30	36	42	48	54	60	66	72	78	84	90	96	102	108	114	120
Select from White, Ivory, Black, Satin Nickel or Bronze Includes Smooth and Insert Strip Option	74	80	86	92	98	106	113	120	127	122	129	140	145	149	154	176	198

Fabric Wrapped Designer Cassette is not available with E Screen 5%

Fascias	24	30	36	42	48	54	60	66	72	78	84	90	96	102	108	114	120
Three Inch Fascia	45	49	51	52	60	68	75	82	90	97	105	114	119	126	134	166	174
Four Inch Fascia	59	64	67	69	77	89	97	107	118	126	137	149	156	165	176	217	227

Cordless Roller

Cordless with Deco-Bar*	Add \$40
Cordless with Cassette	Add \$40 PLUS the Designer Cassette Surcharge to Standard Rectangular Price

*Minimum width is 19½", Maximum width is 96", Maximum length is 96"

Two on One Head Rail

Two on One Head Rail	Price as two separate roller shades with Designer Cassette option and add together.
----------------------	---

Highlights Cornice Valance	24	30	36	42	48	54	60	66	72	78	84	94	102	106	112	118	124	130	136	144
Highlights Cornice Valance (No Keystone)	76	84	92	99	108	113	119	125	130	135	141	150	Requires keystone. See pricing below							
Highlights Cornice Valance (with Keystone)	102	110	118	125	134	139	145	151	156	161	167	176	189	195	202	209	216	224	232	240

Highlights Valance with Keystone: All valances made over 94" wide will require a keystone (shaded area). See pages 75 - 77 for more information.

Scotchgard™ Stain Protection

Scotchgard™ Stain Protection	Add \$35 to the standard rectangular price
------------------------------	--

Bottom Rail Tassel Pulls: See page 83 for pricing and information.

Motorization: Available with Designer Cassette, 3" Fascia, 4" Skyline Fascia, and Standard Roller

Add below Motorization surcharges to base shade price, plus desired hardware option.

Simplicity Motorization Rechargeable and Non-Rechargeable	Add \$289 per shade
Simplicity 5 Channel Remote	Add \$40 per remote
NEW Simplicity 6 Channel Timer Remote	Add \$65 per remote
NEW PowerTouch Rechargeable	Add \$99 per shade (available with and without cassette)
Simplicity Rechargeable Motor Battery Charger	Add \$26 per charger
NEW Simplicity Smart Controller for Android and iPhone	Add \$330 per controller (see page 32 for more information)

Tube Information for Clutch Operated Shades Only (Standard and Skyline):

- **Section 1:** Shades to the left of the dashed line require a 1" tube/1" clutch
- **Section 2:** Shades to the right of the dashed line require a 1½" tube/R8 clutch
- **Section 3:** Shades in the blue section require a 2" tube/R16 clutch.
- **Section 4:** Shades in the orange section require a 2½" tube/Galaxy 200 clutch

Color Lux® General Information

COLOR LUX® GENERAL INFORMATION



COLOR LUX®
Designer Cellular & Roller Shades

Cut-Outs, Scotchgard Protection, Certified Fabrics and Highlights Cornice Valances

Cut-Outs

Cut-outs are available with all cellular fabrics. Cut-outs are \$52.00 per side and are subject to approval by the Comfortex Technical Service department.

There are no limits on cut out lengths. There are limits on cut out widths:

Cellular shade widths 18" or less 3" maximum width

Cellular shade widths greater than 18" 5" maximum width

Scotchgard™ Protection

Scotchgard™ Protector is available with Color Lux Cellular, Roller and Panel Track Shades.

Scotchgard™ keeps your shades looking newer, fresher and cleaner longer.



A combination of the latest advances in stain release and repellency provides exceptional stain protection. Spills wipe away easily and most dirt and stains lift out when cleaned.

Certified Fabrics

GREENGUARD Indoor Air Quality Certified® Fabrics
The GREENGUARD Environmental Institute has established performance based standards to define goods with low chemical and particle emissions for use indoors.

Color Lux Linen Weave fabrics have received GREENGUARD Indoor Air Quality Certified® certification for low emitting interior building materials, furnishings, and finish systems.

Highlights Cornice Valances

Elevate your windows to a whole new level of design with the Highlights Cornice Valance. Coordinate with other design elements in your room and add a finishing touch to the top of any window treatment. The Highlights Cornice Valance is versatile and beautiful at a price point that won't leave you wondering how to cover the rest of your windows!

Choose from any color in the Color Lux Roller line and customize the valance with our 7 available return sizes to best fit your application.

Easy assembly and quick installation, with the Highlights Cornice Valance, more beautiful windows are within your reach.

Shade Stack Heights

Measurements are in inches. Shade stacking heights applicable when the shade is in the fully raised position.

	48"	72"	84"	96"
Standard Rectangular (Includes head and bottom rails)	2	2 ³ / ₈	2 ⁵ / ₈	2 ⁷ / ₈
Top Down - Bottom Up (Includes head, middle and bottom rails)	2 ⁵ / ₈	3	3 ¹ / ₄	3 ³ / ₈
Cord Loop (Includes head and bottom rails)	3	3 ³ / ₈	3 ⁵ / ₈	3 ⁷ / ₈
Motorization (Includes head and bottom rails)	3	3 ³ / ₈	3 ⁵ / ₈	3 ⁷ / ₈

	48"	60"	72"	84"
Cordless Ultra (Includes head and bottom rails)	3	3 ¹ / ₄	3 ³ / ₈	3 ⁵ / ₈
Cordless Ultra Top Down - Bottom Up (Includes head, middle and bottom rails)	3 ⁵ / ₈	3 ⁷ / ₈	4	4 ¹ / ₄
Cordless Lift & Lock (Includes head and bottom rails)	2 ³ / ₄	3 ¹ / ₈	3 ³ / ₈	3 ⁵ / ₈
Cordless Lift & Lock Top Down - Bottom Up (Includes head, middle and bottom rails)	3 ⁷ / ₈	4 ¹ / ₄	4 ¹ / ₂	4 ³ / ₄

Child Safety

Comfortex has a long history of designing new child-safety products is proud to provide a leadership in cooperating with the Consumer Product Safety Commission (CPSC) the development of policies and guidelines for the industry by serving on the WCMA Standards Development Committee.

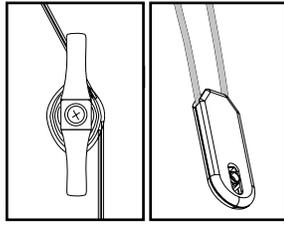

Cord Cleat

Cord Tensioner

All Comfortex products have been fully tested and proven to comply with the current WCMA Standards for safety of corded window coverings.

Be aware that it is possible for children to become entangled in window covering cords. To reduce the risk of accidents, all cords must be kept out of the reach of children. A cord cleat or cord tensioner is an effective way to implement this essential precaution. Please use them.

To mount the cord cleat at a safe height, take into account furniture or other objects upon which a child may climb. Then, after the use of the blind, simply wrap the excess cord around the cleat.

Cleaning and Care

While beautiful and pleasing to the eye, all Comfortex products are designed to be durable, easily cared for and easily cleaned. Our non-woven fabrics are inherently anti-static and repel dust, but occasional feather dusting or vacuuming may be necessary to keep the fabrics clean and bright. Comfortex Color Lux Cellular fabrics may be ultrasonically cleaned.

Our light filtering and room darkening fabrics are inherently anti-static and repel dust, but occasional cleaning may be necessary to keep the fabrics clean and bright. The fabric can be dusted with a soft, clean cloth, feather duster or lightly vacuumed with a soft brush attachment. Spills and stains can be lightly blotted with a cloth or damp sponge. More difficult stains may require soaking in water with mild soap. For this, remove the shades from the window and soak in warm water. Complete immersion of hardware is not recommended.

DO NOT submerge the Cordless Ultra head rail in water. When damp, lay flat to dry or place back in window and raise tightly to recrisp pleats. Please test any stronger cleaners on an unobtrusive portion of the shade before using.

For additional advice on care or cleaning, please contact our Technical Services Department.

Scotchgard™ Treated Shades

The following are the recommended cleaning and care instructions for window treatments with fabric treated with Scotchgard™ Protector.

- Gently blot liquid stains immediately with a clean, white cloth.
- If stain remains, prepare a solution of ¼ teaspoon of clear, non-bleaching dish detergent mixed with 1 cup of lukewarm water. Dampen a clean white cloth and gently blot the stain.
- Do not over wet the fabric or excessively rub the stained area.
- See the Installation and Care instructions for complete details.

For additional assistance with stain removal, call the Scotchgard™ Protector Service Center at 1-800-433-3296. Customer Care representatives are available Monday through Friday, 8am to 6pm CT.

⚠ WARNING	
	The cords on this product present a potential strangulation hazard.
	For child safety, consider cordless alternatives or products with inaccessible cords.
⚠ ADVERTENCIA	
	Los cordones de este producto representan un peligro potencial de estrangulamiento.
	Para la seguridad de los niños, utilice alternativas sin cordón o productos cuyos cordones sean inaccesibles.
⚠ MISE EN GARDE	
	Les câbles de ce produit représentent un danger potentiel de strangulation.
	Pour la sécurité des enfants, pensez au sans fil, ou procurez-vous des produits dont les câbles ne sont pas accessibles.

Measuring Instructions

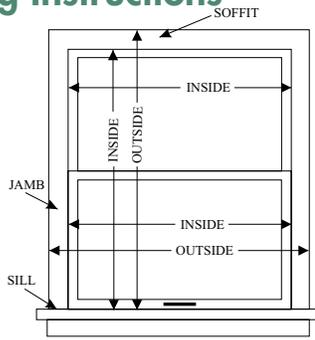

Comfortex accepts measurements down to $\frac{1}{16}$ " increments.

Inside Mount

Use a steel tape to measure the opening at three different places, and use the narrowest dimension when ordering. Be exact! The factory will make the shade $\frac{3}{8}$ " narrower so it will not rub against the window casing. Measure the height of the window from the top (soffit) down to the sill.

Outside or Ceiling Mount

Use a steel tape to measure the exact height and width of the area to be covered. It is recommended that the shades overlap the window by at least $1\frac{1}{2}$ " on each side. When installation has no sill, allow the shade to overlap the bottom of the window casing by at least $1\frac{1}{2}$ ". Shade fabric will measure width indicated on the order form.

Measuring for Specialty Shapes

Templates are required with some specialty shade orders. Consult the individual product sections of this guide for specifics regarding accurate measurements and mounting information.

Arches and Quarter Round Circles

- Measure the window height and width appropriately for an inside or outside mount.
- With perfect arches, the height will be one half the width. With perfect quarter rounds, height will equal width. If the arch or quarter round is perfect, **a template is not required.**
- Windows with imperfect arch measurements do not maintain the height/width relationship. Templates **are required** for these windows.

Trapezoids

- Measure the window height and width appropriately for an inside or outside mount. For outside mounts, remember to add the desired amount of overlap.
- Either the top or bottom of the shade is sloped or angled.
- Measure all four sides for accurate fabrication. Provide all measurements. **Templates are not required.**
- The slope angle must be measured with a protractor. Slope is the angle between slope and a horizontal line. The maximum slope is 30 degrees.

Octagons

- **Templates are required** and must be cut out of brown craft paper.
- Measure the window height and width appropriately for an inside or outside mount. Be sure to measure the width at the shade's widest point.
- Provide the width, length and the length of one side when ordering.

Making the Perfect Template

Tape brown craft paper over the window opening. Be sure to allow plenty of overlap and check to see that the paper is smooth and pulled taut. Do not use newspaper as the ink can rub off on fabric. Do not use paper that has been folded. Notice the outline of the framework superimposed on the template as the light filters through the window. You may create the template in one of two ways:

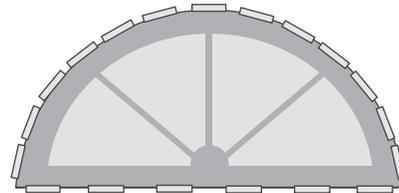

Trace the outline of the window with a pencil and continue along the side of the window frame. Once the window is completely traced, remove the craft paper from the window. Cut out the traced shape with a pair of scissors.

You may choose to skip tracing the window outline with a pencil and cut out the shape immediately with a razor knife.

Once your template is cut, double check its width and height with your initial measurements. Test the template by placing it in the window. Check for light gaps, uneven cutting of curves etc. Trim or remake if necessary.

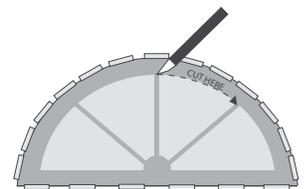

With arch top shades, fold the template in half. Check the outline of the curve for smoothness, light gaps and curve continuity. Place the template in the window and check it for light gaps or uneven cutting of curve. Trim or remake it if necessary.

On the front of the template, mark the shade measurements along with your company name, account number, sidemark, shade style and color. Be sure to indicate inside or outside mount, the room side and which ends of the template are top and bottom. Do not take any deductions on inside mount shades. The factory will make all necessary allowances for inside mounts.

Remember: The quality of the finished shades depends heavily on the quality of the template supplied. Do not hesitate to remake a template if you feel uncomfortable of the quality of your first attempt.

Template Kits: Comfortex offers template kits which includes brown craft paper, razor knife, instructions and order form. Please contact Customer Service or visit www.comfortexdealers.com to order. Stock number: 751000

Conditions of Sale

All Comfortex products are custom fabricated to your exact specifications. We cannot accept responsibility for errors in ordering or cancellations and charges after the order is in production.

Policies

Our policies are designed to provide a guide for doing business with Comfortex. Our first priority and number one policy is to provide the highest level of service and total satisfaction.

Freight

Comfortex will ship all orders for fabricated shades freight free via UPS, FedEx Ground or other similar method within the continental United States*.

A \$3.75 per unit transportation surcharge will be added to all fabricated product orders, within the continental United States, including shades/blinds, vane packs, individual vanes, tracks, valance and cut yardage orders.

In addition, a \$70.00 Common Carrier surcharge** will be added for all orders shipped within the continental United States*, that include shades or blinds with widths of 98" or more and are required to ship by motor freight.

***Hawaii:** Shipments to the Hawaiian island of Oahu will incur a freight charge of \$80.00 per order, plus \$3.75 per unit. All other Hawaiian islands will incur an \$100.00 per order freight charge, plus \$3.75 per unit.

****Hawaiian Common Carrier Surcharge:** An \$110.00 Common Carrier surcharge for oversized shipments will be added to orders shipping to Hawaii.

***Alaska:** Shipments to Alaska will incur a \$6.00 per unit transportation surcharge.

****Alaska Common Carrier Surcharge:** An \$110.00 Common Carrier surcharge for oversized shipments will be added to orders shipping to Alaska.

Canada: Shipments to Canadian dealers will incur a \$3.75 per unit transportation surcharge. In addition, ground shipping charges will be invoiced on a monthly basis as a percentage of the shade order value, together with a \$110.00 Common Carrier surcharge for oversized shipments. Ground Shipping charges are as follows: (\$1.00 to \$1,000 = 7%, \$1,001 to \$5,000 = 6%, \$5,001 to \$10,000 = 5%, and \$10,001 or more = 4%).

Comfortex Mexico Plant: All shipments from our Mexico plant to Alaska, Hawaii or anywhere outside the Continental US will incur all freight charges (freight forwarder needed if shipping to another country).

All Other Countries: All United States dealers requesting to ship orders outside the United States must provide a freight forwarder for Comfortex to ship to within the continental United States. Comfortex cannot ship directly to your customers located outside the United States.

Please Note: Comfortex reserves the right to select another carrier, modify shipping terms or change freight policies without notice.

Service and Repair

Service may be obtained by contacting our Customer Service Department. No products, parts, components or other materials will be authorized for return or repair without prior approval from Comfortex. A Return Authorization (RA) may be obtained by contacting our Technical Service Department. In order to provide the quickest service possible, please have your Comfortex Work Order number and original order information available when you call.

Specifications

All Comfortex products are designed and tested to perform as intended within established, published parameters. Requests for "custom fabrication" of products outside of our published specifications may be considered, but are at the discretion of the Comfortex Technical Services department. Restrictions and additional charges apply.

Download installation instructions, order forms or additional price list copies on the Comfortex OnDemand Library or www.comfortexdealers.com in the Dealers Resource Center.

Motorized Color Lux Cellular Shades Warranty

Standard Simplicity and Simplicity Rechargeable Motors

We offer a 5 year warranty on all motors and controls. Specifically, we warrant the Simplicity motors and controls to be free from defects in material and workmanship under normal and proper use for a period of 5 years commencing with the date stamped on each product. If the Simplicity product fails within this 5 year period, we will repair or replace it free of charge through end user product supplier. Comfortex will warranty non-rechargeable alkaline batteries for up to 3 months from date of purchase. Simplicity Rechargeable (NiMH and Li-Ion batteries) are covered by a 5 year warranty.

Color Lux Color Warranty

Comfortex utilizes state of the art technology to provide you Color Lux Shades within 2 Delta-E (DE) of the sample fabrics found in the Color Lux Sample Book. When viewed under different lighting sources such as fluorescent, incandescent, halogen, ultraviolet and others, fabrics may appear different to the eye. Comfortex utilizes the worldwide lighting standards of Daylight 65 (D65) as our official standard for measuring and qualifying color accuracy, because D65 daylight bulbs best represent actual "daylight" illumination. Slight color variations (under 2 DE) are within established industry standard and should be expected. This warranty is in addition to Comfortex limited lifetime warranty.

Scotchgard™ Warranty

Comfortex Window Fashions provides a limited warranty for fabrics treated with Scotchgard™ Protector against permanent stains for a period of 1 year from the date of original purchase.

This warranty excludes conditions or damages resulting from accidents, alterations, exposure to the elements, and exposure to any and all natural and manufactured excessive heat sources, or failure to follow the Installation and Care instructions. This warranty also excludes fabric submerged in water or cleaning solutions, or treated with household products that may alter or deplete the effectiveness of the treated fabric. In addition, the following types of stains are excluded from this limited warranty: pet stains, bodily fluids, stains caused by wine, bleach, plant fertilizers, acne medication, misuse or abuse. This warranty is not a cleaning contract and does not cover the cleaning of fabrics that are soiled or discolored through daily use. This warranty coverage is limited to residential use and is not transferable.

The following are the recommended cleaning and care instructions for window treatments with fabric treated with Scotchgard™ Protector.

- Gently blot liquid stains immediately with a clean, white cloth.
- If stain remains, prepare a solution of ¼ teaspoon of clear, non-bleaching dish detergent mixed with 1 cup of lukewarm water. Dampen a clean white cloth and gently blot the stain.
- Do not over wet the fabric or excessively rub the stained area.
- See the Installation and Care instructions for complete details.

For additional assistance with stain removal, call the Scotchgard™ Protector Service Center at 1-800-433-3296. Customer Care representatives are available Monday through Friday, 8am to 6pm CT.

Should the results of the cleaning and care instructions not result in the removal of permanent stains covered by this limited warranty, Comfortex will retreat or replace the fabric, at its discretion, for a period of 1 year from the date of original purchase. Customer must provide proof of purchase and provide proof the stain occurred during the warranty period. Shipping and handling costs to send the window treatment back to Comfortex are the responsibility of the customer.

This warranty gives you specific legal rights, and you may also have other rights which vary from state to state.

Color Lux Cellular, Roller and Panel Track Shades Warranty Information

Comfortex Window Fashions warrants that its window treatments will be free from defects in materials and workmanship for as long as the original residential purchaser owns the product, provided that the product was installed properly and in accordance with the installation instructions. The limited lifetime warranty is extended to the original residential purchaser only, in the original window for which it was installed.

The warranty does not include any conditions or damages resulting from accidents, alterations, misuse, abuse, misapplication, improper handling, installation, repairs, operation, cleaning, exposure to any and all natural and manufactured excessive heat sources. (Excessive heat sources include, but not limited to; magnification of sun light through cubes of glass, heaters of any kind, ovens, candles, lighting fixtures, etc.) This warranty does not cover variation in fabric color, grain, or texture. Loss of pleating is not covered if the product is not being cycled (held in the raised position a portion of the time). Normal wear and tear is not covered.

All moving parts, such as cords, will eventually wear out and fabric may fray. Comfortex considers these things as normal wear and tear which will carry a three year limited warranty. All fabric, including fabric vanes, panels, inserts, and shades carry a five year warranty.

This limited warranty does not cover transportation costs to and from the retailer, costs of removal, re-measure, re-installation of product, or any incidental or consequential damages.

If a Comfortex product is found to be defective in materials or workmanship, we will, at our discretion, repair, replace or refund the cost of a product which fails to conform to this limited warranty. Colors vary from lot to lot and may not exactly match sample swatch, sample book, or previous purchases. Discontinued components or color selections will be replaced with the closest equivalent current product. This shall be your sole remedy under this limited warranty.

To obtain service, the end user should contact the dealer from whom they purchased the product.

This warranty is exclusive and in lieu of all other obligations, liabilities or warranties. In no event shall Comfortex or its licensed fabricators or distributors be liable for incidental or consequential damages, or for any other damage, loss or expense, cost or fee associated with such damage. In some states, exclusions for incidental or consequential damages are not allowable.

This warranty gives specific legal rights, and customers may also have other rights, which vary from state to state. Policy is subject to change without notice.

This limited warranty is exclusive of commercial use. Contact Comfortex Technical Service for more information. No agent, representative, dealer or unauthorized employee has the authority to increase or alter the obligation of this warranty.

This limited warranty supersedes any previous versions.

COLOR LUX® GENERAL INFORMATION

©2017 COMFORTEX CORPORATION

™ is a trademark of Comfortex Corporation. ® is a registered trademark of Comfortex Corporation. Scotchgard, 3M and the Plaid Design are trademarks of 3M. The GREENGUARD INDOOR AIR QUALITY CERTIFIED Mark is a registered certification mark used under license through the GREENGUARD Environmental Institute. Energizer® is a registered trademark of Energizer Holdings, Inc. . Ovation™ Cellular Slider is covered by one or more of the following U.S. Patent Nos.: 4,862,941, 4,858,668, 4,915,153, D346,032, D324,108, 4,450,027, 4,631,108, 4,603,072, 5,690,778, 5,664,773, 6,319,586, 5,482,750, 5,601,885 and 4,631,217. Karma-Light™, Cordless Ultra™, Sunset™, and Ovation™ are trademarks of Comfortex Corporation. Other U.S. and foreign patents pending.



Color Lux® Cellular Shades | Perfect Pastels | Artic Shadow

What's Inside:

- Simplicity Rechargeable Motorized Shades
- Introducing NEW Roller and Panel Track fabrics
- Fabric Wrapped Hardware Standard on Cellular Shades
- Optional Scotchgard™ Stain Protection
- 800 Color Collection - **Color without Compromise!**



www.midwestdesignersupply.com

888-523-2611
262-524-1007 (fax)

