



THE FINIAL COMPANY

2013 Drapery Hardware Catalog

◀ *Pictured on the cover...*
WW70 finial in new finish 610 Cobalt Bronze.

table of contents

introduction	1	
	table of contents	1
	introduction	2
	how to measure	4

custom solutions	5	
	custom steel brackets	6
	bypass brackets	7
	swing arms	7
	finial adaptors	8
	custom tiebacks	8
	custom pole returns	9
	corner and bay window miters	10
	arched windows	12

steel	13	
	1/2" diameter products	14
	3/4" diameter products	16
	1" diameter products	22
	1 1/4" diameter products	28
	1 1/2" - 1 3/4" diameter products	34

wood and resin	41	
	1 3/8" diameter products	42
	2" - 2 1/4" diameter products	46
	3" diameter products	58
	rosettes	64
	tiebacks	70
	crests	72

special collections	73	
	essential sets	74
	the modern collection	76
	outdoor hardware	78

traverse systems	81	
	corded traverse	82
	motorized traverse	83
	traverse finish reference	84

etc.	86	
	display boards	86
	terms and conditions	87
	index	88
	finishes	92



High quality, hand finished finials and every one is custom.

In this catalog, we've focused on you, our customer. We've made it easy for you to find exactly what you're looking for. The Finial Company has always aimed to provide you with a myriad of choices, and now our extensive line of drapery hardware has been categorized by diameter.

As we set about reorganizing this catalog, we added new items in nearly every diameter. We honed our finial choices to include only the finest selections while broadening the mix with exciting new traditional and transitional designs in several categories.

Beyond our vast selection of standard drapery hardware, we offer our Special Collections. Here, you'll find solutions for niche markets. The Outdoor Hardware Collection is guaranteed to withstand nature's elements; The Modern Collection lends itself to sleek contemporary settings; and our newest offering, Essential Sets, is an exclusive selection of complete drapery hardware sets, created with your convenience and cost savings in mind.

Yes, we are known for our broad range of products, but did you also know we offer state-of-the-art technology? Our 2", 2¼" and 3" Wood and Resin Collections can be outfitted with motorized traverse systems, controlled by a hand-held remote, wireless wall switch or central home automation system.

Other drapery hardware companies can make similar claims. What makes us different? Flexibility. Don't see what you need in our catalog? Call us.

You will never be limited by our finish selections – we will custom match any color, any tone, any highlight.

You will never be held back by our design offering – we strive to provide you with the widest range of finial styles, including traditional, transitional and modern designs.

You will never be hindered by an unusual window shape, difficult floor plan, or constricted space – we will customize our products to fit your every need.

We offer you this multitude of choices so that we can make your design visions a reality. All with the outstanding quality and exceptional service you've come to expect from The Finial Company.

Customization has always been our custom. Let us prove it to you.

THE FINIAL COMPANY

...our name says it all



how to measure

1. Measure the window width from outside the casing edges. We recommend at least 2" to 4" per side for bracket placement, or finding wall studs on each side of the window in which to drill. Installing the brackets into wall studs is the safest and most secure installation method. Refer to window illustration below.
2. If a window is in the corner, make sure there is enough room to accommodate the finial.
3. The height of the bracket position is determined by the finished drapery length and style. If the treatment is designed to be used with rings, be sure there is proper allowance for the drop of the ring. Refer to the ring illustration below.

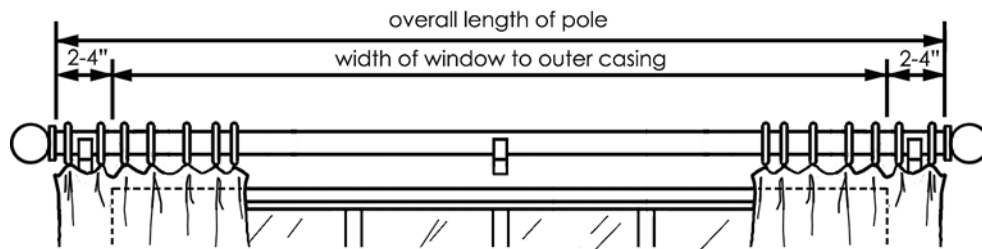

Before you can choose which bracket, ring, and pole diameter to order, you must determine how much room you will have above and to the sides of your window. Some brackets have tall backplates that may either look too large or may not fit into tight spaces.

Things to consider:

1. Does the bracket backplate fit between the top of your window and the ceiling?
2. At what height do you need the pole to be positioned? Will this bracket accommodate your window installation design?
3. If you plan to use rings, what height does the top of your drapery panel need to reach? Will your choice of bracket, ring, and pole diameter accommodate your window treatment design?

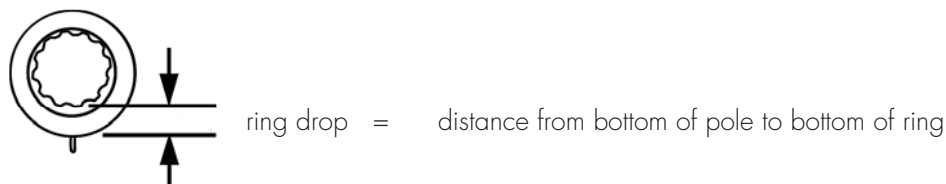

The ring drop determines the height at which the top of the drapery panel will be installed, if using rings. If not using rings, the pole should be installed at a height suitable for a drapery rod pocket or other type of drapery treatment.

We recommend using a professional installer to measure and install your drapery hardware treatments whenever possible.



custom solutions

Custom Steel Brackets	6
Bypass Brackets	7
Swing Arms	7
Finial Adaptors	8
Custom Tiebacks	8
Custom Pole Returns	9
Corner and Bay Window Miters	10
Arched Windows	12





custom solutions

The Finial Company is known for flexibility. Custom Solutions are our specialty. Whether you need a custom bracket, special miter, or custom match finish, let us create one-of-a-kind drapery hardware to fit your special window.

custom steel brackets

If you have a special need, we can create the following brackets to your specifications.



TBKT
custom steel t-bracket
please specify:
A. return (distance from wall to center of cradle)
B. pole size and profile
note: 3½"H backplate comes standard, unless otherwise specified



DBL1
custom steel double bracket
please specify:
A. front pole size and profile
B. back pole size and profile
C. rings to be used, if any
D. front and back returns (distance from wall to center of cradle)
note: returns are contingent upon which poles and rings are chosen
3½"H backplate comes standard, unless otherwise specified



BL4
custom steel ceiling mount bracket
please specify:
A. drop (distance from ceiling to top of pole)
B. pole size and profile
C. rings to be used, if any
note: minimum drop is contingent upon which finial and ring are chosen.
2½"W ceiling plate comes standard, unless otherwise specified



FBKT
custom steel single bracket
please specify:
A. return (distance from wall to center of cradle)
B. pole size and profile
note: 4¾"H backplate may not be modified

Return or drop distance in excess of 8" on any custom bracket will incur additional fees and requires addition of support arm. Custom brackets are shown unfinished.

Want to further customize your steel products? We can add a variety of decorative items to our steel products for you. *Additional charges apply.*



SL
short leaf
6"L x 1¾"W
This leaf can be welded to the front of any steel bracket with a maximum return of 3½".
When ordering your bracket, please specify addition of SL.



LL
long leaf
11½"L x 1¾"W
This leaf can be welded to the front of any steel bracket with a maximum return of 8".
When ordering your bracket, please specify addition of LL.



SL3
steel leaf
2¼"L x 1¾"W
SL3 welded to SR3 ring
This leaf can be welded to any steel ring or steel bracket.
When ordering your ring or bracket, please specify addition of SL3, and in what position it should be attached.



SL3 welded to SR3 ring

Add any rosette medallion or end cap to the front of any standard or custom steel bracket.

When ordering your bracket, please specify addition of rosette medallion and the following:

1. which rosette medallion or end cap to be added
2. attachment method:
 - a. machine screw (medallion may easily be changed later)
 - b. weld (permanent attachment; only available for steel rosettes or steel end caps)

please note: rosette medallions and brackets sold separately
additional charges apply



EC1 welded to front of bracket L135, RR100 pole, SR3 rings, finish 620 Weathered Iron

For additional information on how to order custom brackets, please refer to the Retail Price List.

bypass brackets

Our bypass brackets and C-rings allow continuous ring movement along the length of your pole. These work particularly well for long one-way draw treatments, unusually wide windows, and walls featuring multiple windows.

Please note: to be used in conjunction with cradle brackets; not for use with curved poles.

SCB35
single bypass bracket
standard 3½" return

SCB6
single bypass bracket—
standard 6" return

SCBC **NEW**
single bypass bracket—
custom return

please specify:
A. RR100 (1"),
RR125 (1¼"), or
RR175 (1¾") pole

B. return (distance from wall
to center of cradle)

note: return may be
restricted by the size of
poles and rings specified



SCB35



SCBCDBL **NEW**
double bypass bracket
custom front and back
return

please specify:
A. RR100 (1"),
RR125 (1¼"), or
RR175 (1¾") pole

B. front and back returns
(distance from wall
to center of cradle)

note: return may be
restricted by the size of
poles and rings specified

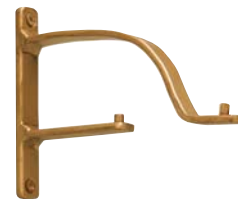

SCBCDBL



CRSR3
C-ring
1½"ID x 2"OD
use with RR100 pole



CRSR7
C-ring
2¼"ID x 2¾"OD
use with RR125 pole



CRSR12
C-ring
2½"ID x 3"OD
use with RR175 pole



Return in excess of 8" on any custom bypass bracket will incur additional fees and requires addition of support arm.
Custom bypass brackets are shown 680 Aged Gold. For additional information on how to order, please refer to the Retail Price List.

swing arms

Swing Arms can be a nice solution for window treatments in front of doors, shutters, and other unique areas where the drapery panel needs to conveniently swing out of the way.



large swing arm
maximum length 36"
1" Dia pole RD125
8½"H x 1¼"W backplate
L9328 finial: 1¾" Dia, included
350G Statuary Bronze with Gold

please note: Available with scroll
(as shown) or without; must specify.
Other finials may be substituted.
Replacement finial sold separately.



small swing arm
maximum length 20"
½" Dia pole 50SRB
4"H x ⅝"W backplate
EC4 finial: ¾"L x 1½"W, included
350G Statuary Bronze with Gold

please note: Other finials may be
substituted. Replacement finial sold
separately.

For additional information on how to order, please refer to the Retail Price List.

finial adaptors





If the finial you want isn't shown in the diameter you need, ask us to add a finial adaptor, for a nominal fee. The finial adaptor acts as the new finial base.

Finials are located in certain diameter categories based on the following criteria:

- the finial base fits the pole without additional modification
- finial shape and size is in proportion to the pole diameter

Finial Adaptor Tips:

- It is typically easier and more visually pleasing to adapt a finial to a larger diameter pole, rather than a smaller diameter pole.
- Many finials are located in multiple size categories because they look appropriate for several pole sizes; you may not need an adaptor.

	base adaptor size	use for pole diameters
	small: 1 3/8" Dia	1/2", 3/4", 1", 1 1/4"
	medium: 2" Dia	1 1/2" - 1 3/4"
	large: 3" Dia	2" - 2 1/4"
	FC1: 2 1/2" Dia	1 1/2" - 1 3/4", 2" - 2 1/4"

custom tiebacks



TBA
6" L x 4 1/2" projection
100 Polished Steel*
attach finial or rosette of choice to face or tip of TBA.
pictured with L651 finial
finial sold separately



STBA1
8" L x 6 1/2" projection
610 Cobalt Bronze
attach finial or rosette of choice
pictured with R73 rosette
rosette sold separately

**please note: there is an upcharge for this custom finish; please refer to price list for details.*

custom pole returns

- Bent and mitered return fees are charged per corner; returns over 6" incur additional charges.
- Double pole treatments are also available with bent or mitered returns on the front pole. Please call us for more details.

steel pole bent returns



3/4" 75HSRB with 90° Bent Returns, finish 107 Bronze with Gold and Gray

Available for 1/2" 5OSRB, 3/4" 75RD and 75HSRB poles only.
 Backplate: 1 3/8" Dia (for 5OSRB) or 2" Dia (for 75RD and 75HSRB)
*Pole length and return must be specified; please refer to Retail Price List for list of required measurements.
 Sold in one foot increments, 2 foot minimum charge.*

steel pole mitered returns



1 1/4" SRT2 with Mitered Returns, finish 250 Platinum

Available for any steel pole, except 1 1/4" TWCH125 and 1 3/4" TWCH
 Backplate: 3"H x 1 1/2"W or 3 1/2"H x 2"W, depending on pole diameter
*Pole length and return must be specified; please refer to Retail Price List for list of required measurements.
 Sold in one foot increments, 2 foot minimum charge.
 Ring inner diameter must clear the mitered pole corner, if used. See chart in Retail Price List.*

wood pole mitered returns



2 1/4" 225FL with Mitered Returns, finish 650 Hickory

Available for any wood pole, except 1 3/8" 138TW, 2" 2TR, 2 1/4" 225TR, and 3" 3TR.
*Pole length and return must be specified; please refer to Retail Price List for list of required measurements.
 Sold in 2 foot increments, 2 foot minimum charge.
 Ring inner diameter must clear the mitered pole corner, if used. See chart in Retail Price List.*

please note: Your choice of bracket supports the main length of pole, while the mitered return is joined to the pole via wood glue and nails. Rings and/or draperies should not be installed on the mitered return. Return butts against the wall, and is not attached to the wall. Weight should not be placed on the wood mitered return.

bay window and corner window solutions

We can miter
wood poles,
steel poles,
and traverse
fascia to fit
any corner...



miters for wood poles

- We can miter our wood poles at any angle for you.



Shown: 90° inside corner miter for 225WG wood pole, WL1 steel brackets, finish 710 Tarnished Silver



Shown: 90° outside corner miter for 225WS wood pole, WL1 steel brackets, finish 710 Tarnished Silver

miters and soft bends are great for situations like these....

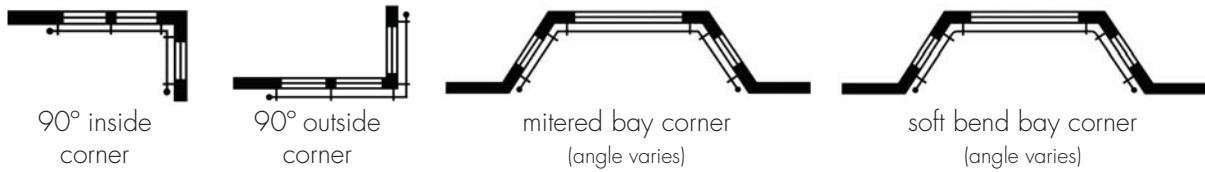

miters for traverse wood fascia

- We cannot miter traverse system tracks, but the traverse wood fascia can connect and miter at the corner.



Shown: 120° mitered bay corner for standard corded traverse system, 225FL wood fascia, finish 740 Smoky Mocha; bronze track, bracket, and components

miters and soft bends for steel poles

- Miters are available for all steel poles, except for 1¼" TWCH125 and 1¾" TWCH.
- Soft bends at a 90° angle or larger are only available for ½" 50SRB, ¾" 75RD and 75HSRB poles.



Shown: 120° soft bend bay corner for 75HSRB steel pole, L135 steel brackets, finish 730 Rose Gold

arched window solutions

- Available for 1/2" 50SRB, 3/4" 75RD and 75HSRB, 1" SRT1, 1 1/4" RD125, SRT2, TWCH125, and 1 1/2" TRT steel poles only.
- Some poles will need to be cut at apex (center) for shipping; some arches cannot be achieved.
- Arched poles with splices are subject to additional bending fees.

IMPORTANT: A template is required to ensure accuracy of production. For information on how to create your template, please refer to the Retail Price List.

standard arch

arch height is equal or greater than half the arch width

eyebrow arch

arch height is less than half the arch width



shown: SR3 rings welded onto 1 1/4" TWCH125 pole
ARBE and L135 brackets
finish 350G Statuary Bronze with Gold

ARBC

arched rod center bracket

Please specify return (distance from wall to center of cradle)

note: cannot be used for installations with rings (brackets without eyelet cradles may be substituted)



ARBE

arched rod end brackets

Sold in pairs only

Please specify return (distance from wall to center of cradle) and pole being used. Cups are custom made to style of pole.

note: outer ring can only reach 1 1/2" from end of pole due to the bracket cup



do you need a vertical or horizontal arch?

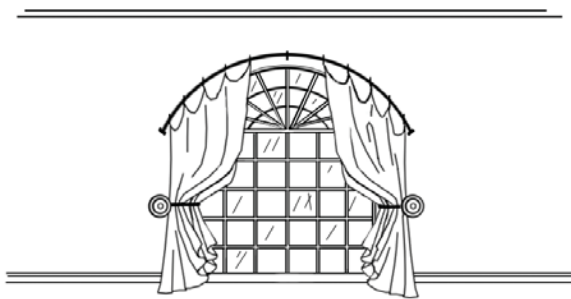

Vertical Arch Installation
great for arched windows

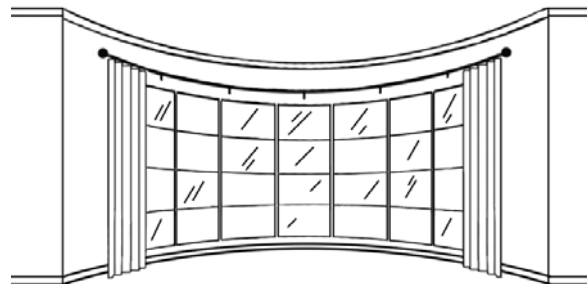

Horizontal Arch Installation
great for curved bay windows

please note: If using rings for vertical arch installation, rings must be welded into place. Ring position must be noted on your template. Outermost rings must be 1 1/2" minimum from end of pole due to ARBE bracket cup. Rings sold separately.

Any steel bracket or finial may be used for this type of arch.

For additional information on how to order, please refer to the Retail Price List.



1/2"

3/4"

1"

1 1/4"

1 1/2" to 1 3/4"

steel

1/2" diameter products	14
3/4" diameter products	16
1" diameter products	22
1 1/4" diameter products	28
1 1/2"–1 3/4" diameter products	34

actual pole sizes

1/2"



3/4"

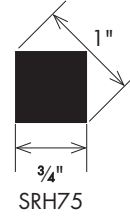
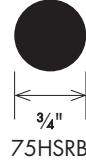
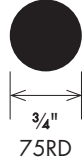
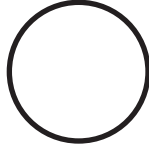

1"

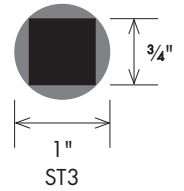
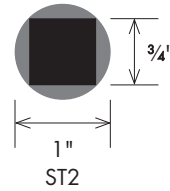
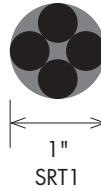
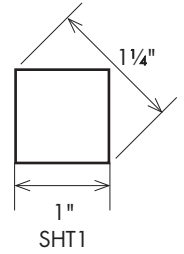
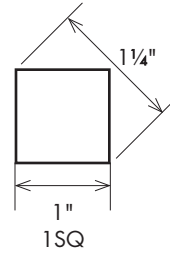
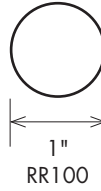
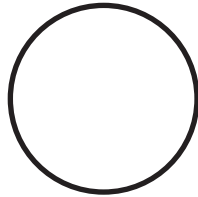

1 1/4"

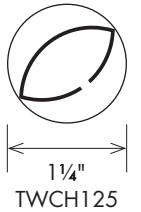
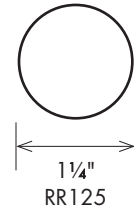
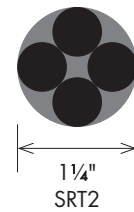
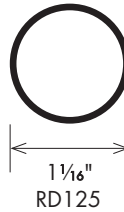
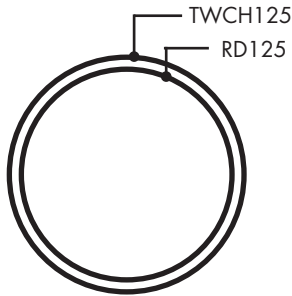

1 1/2" to 1 3/4"

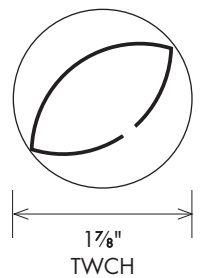
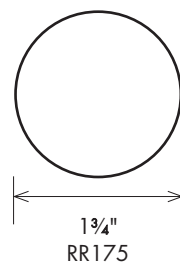
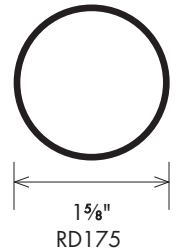
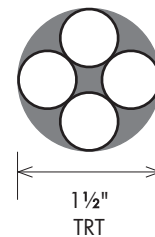
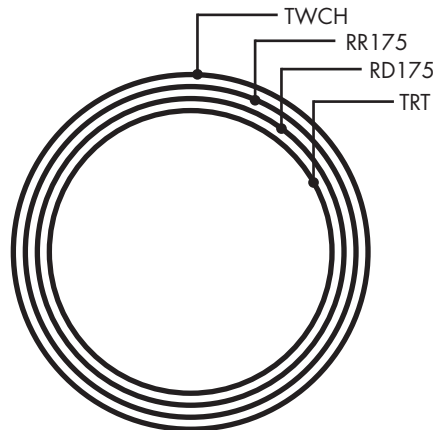



steel

The Finial Company offers an extensive collection of cast and forged steel finials, brackets, poles and rings. Our ability to customize nearly any steel item guarantees you'll find a unique and successful design for your window treatment.

1/2"
steel



F050-3 NEW
 7/8"L x 1"W, 7/8" base
 630 Ash Gray
 pictured with pole 50SRB

SR05 NEW
 smooth steel ring
 3/4"ID, 1 1/8"OD
 630 Ash Gray



F050-1C NEW
 1 1/2"L x 1 3/8"W, 7/8" base
 690 Champagne
 pictured with pole 50SRB



F050-1S NEW
 1 1/2"L x 1 3/8"W, 7/8" base
 660 Antique White
 pictured with pole 50SRB



F050-2C NEW
 1 5/8"L x 1 1/2"W (1 1/8"Sq), 7/8" base
 620 Weathered Iron
 pictured with pole 50SRB



F050-2S NEW
 1 5/8"L x 1 1/2"W (1 1/8"Sq), 7/8" base
 640 Oil Rubbed Bronze
 pictured with pole 50SRB



SF37 NEW
 1"L x 1"W
 600 Gilded Red
 pictured with pole 50SRB



SF38 NEW
 1"L x 1 1/8"W
 610 Cobalt Bronze
 pictured with pole 50SRB



SF35
 1"L x 1"W
 105 Bronze
 pictured with pole 50SRB



S93
 1 3/4"L x 1 1/4"W, 1" base
 320 Pewter
 pictured with pole 50SRB in
 109 Flat Black



EC4
 7/8"L x 1 1/4"W
 150 Gray with Gold
 pictured with pole 50SRB

brackets

1/2"
steel

Redesigned 1/2" diameter brackets feature a discreet cradle with a tighter fit and hidden set screw.



BKT050-1 **NEW**
adjustable steel bracket, single
2" backplate, 2 5/8"-3 1/2" return, 1/2"W



BKT050-2 **NEW**
steel bracket, double
2 1/2" backplate, 6" front return,
3" back return, 1/2"W



BKT050-3 **NEW**
steel bracket, single
2 1/2" backplate, 6" return, 1/2"W



IMB050-1 **NEW**
inside mount bracket, pair
1" backplate, 3/4" Deep, 3/4"W

Return distance is from wall to center of cradle. All brackets are shown in 680 Aged Gold.

accessories



SBTN
steel baton, paint only
3/8"Dia
specify length up to 96"



125ELB
flexible elbow for connecting 1/2"-1 1/4" diameter poles
2"L (1 3/4"L when bent), 1 1/4" base

poles



50SRB steel pole, 1/2" Dia round solid pole
maximum length is 240 inches



1/2" steel poles are sold in 1 foot increments, 2 foot minimum. Poles will be cut to specified length. Fall off will not be saved or shipped.

rings



SR05 **NEW**
smooth steel ring
3/4"ID, 1 1/2"OD
680 Aged Gold



SEC125 **OH**
1/4"L x 1 1/4"W
680 Aged Gold
pictured with pole 75RD



EC4
7/8"L x 1 1/4"W
150 Gray with Gold
pictured with pole 75RD



SF36
1 1/4"L x 1 1/4"W
105 Bronze
pictured with pole 75RD



S93
1 3/4"L x 1 1/4"W, 1" base
320 Pewter
pictured with pole 75HSRB



SF202A
1 5/8"L x 1 5/8"W
750 Polished Gold
pictured with pole 75RD



SF202B
2"L x 2"W
640 Oil Rubbed Bronze
pictured with pole 75HSRB



SF3
2 1/4"L x 1 5/8"W, 1 1/4" base
129 Antique Steel
pictured with pole 75RD



SF180
3 7/8"L x 2"W, 1 3/4" base
710 Tarnished Silver
pictured with pole 75RD



SF1
3 3/8"L x 2 3/8"W, 1 5/8" base
610 Cobalt Bronze
pictured with pole 75HSRB



L651
5 1/8"L x 3 7/8"W, 1" base
110 Flat Black with Gold
pictured with pole 75RD

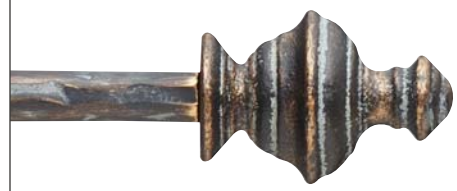

SF69
3 1/2"L x 2 1/2"W, 1 3/4" base
620 Weathered Iron
pictured with pole 75HSRB



SF133
2"L x 2 3/8"W, 1 1/4" base
690 Champagne
pictured with pole SRH75



45834
2 1/4"L x 1 1/4"W, 1 1/4" base
740 Smoky Mocha
pictured with pole 75HSRB

OH item is available in Outdoor Hardware, pages 78-80



SF201
2 3/4"L x 1 5/8"W, 1 1/4" base
630 Ash Gray
pictured with pole SRH75



SF135
2"L x 2"W, 1 3/8" base
250 Platinum
pictured with pole 75RD

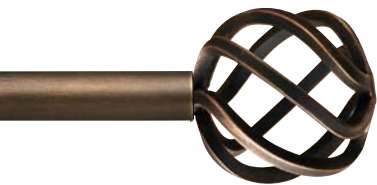

SF158B7
3"L x 2 3/4"W
106 Bronze with Gold
pictured with pole 75RD



SF236
3 1/4"L x 3"W, 1 3/8" base
250B Platinum with
Black Highlights
pictured with pole 75RD



K657
4"L x 2"W, 1 3/4" base
110 Flat Black with Gold
pictured with pole 75RD



L885875
5 3/4"L x 3 3/4"W, 1 1/2" base
107 Bronze with Gold
and Gray
pictured with pole SRH75

custom solutions

Do you need a custom return on your steel bracket? Or perhaps you'd like to add a rosette to the front of your bracket... we can do that for you!



For more ideas on how to customize your steel brackets, turn to page 6 in Custom Solutions.

Did you know we can add a soft bend to your 3/4" solid 75RD and 75HSRB poles? This is a great solution for bay windows.



To find out more about bends and miters for all poles, turn to page 10 in Custom Solutions.

Do you wish your 3/4" finial could fit a larger pole diameter? It can with the addition of a finial adaptor.



See page 8 for more details.



SF1848 **OH**
7 1/2"L x 4 1/4"W, 1 1/4" base
110 Flat Black with Gold
pictured with pole 75RD



SF216
5 3/4"L x 6 5/8"W, 1 1/4" base
270 Mahogany Rust
pictured with pole 75RD



SF66
7"L x 5 3/4"W, 1 1/2" base
please specify right (shown) or left
129B Antique Steel with Black
pictured with pole 75HSRB



SF22
5 1/4"L x 5"W, 2" base
please specify right (shown) or left
790 Vintage Bronze
pictured with pole 75RD

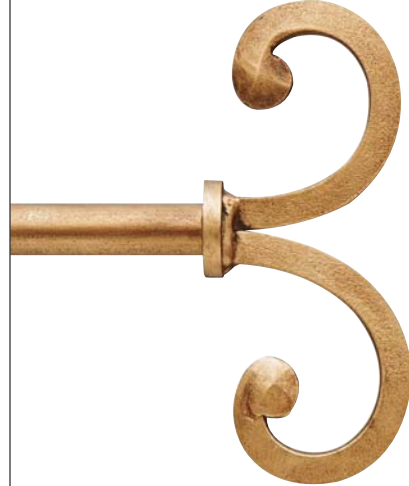

SF19
3 1/2"L x 6 3/4"W, 1 3/8" base
680 Aged Gold
pictured with pole 75RD



SF21
6 1/2"L x 5 1/2"W, 1 1/4" base
129B Antique Steel
with Black Highlights
pictured with pole 75HSRB
please specify right (shown) or left



SF205
8 1/4"L x 5 1/2"W, 1 1/4" base
100 Polished Steel*
pictured with pole 75HSRB

SL3
custom steel leaf
attached to SR1 ring
(incurs additional fee)
2 1/4"L x 1 3/4"W
100 Polished Steel*
SR1 sold separately

*please note: there is an
upcharge for this custom finish;
please refer to price list for
details.

OH item is available in Outdoor Hardware, pages 78-80



PBN
pine cone branch with needles
12½"L x 7"W, 1⅜" base
please specify right (shown) or left
106 Bronze with Gold
(needles are copper wire)
pictured with pole 75HSRB

PB
pine cone branch (no needles)
12½"L x 7"W, 1⅜" base
available, not shown



Branch with Leaf
14"L x 10"W, 1⅜" base
please specify right (shown) or left
270 Mahogany Rust with custom green* on leaves
pictured with pole 75RD

**please note: there is an upcharge for this custom finish; please refer to price list for details.*

SR1
smooth steel rings
1" ID, 1½" OD
270 Mahogany Rust



BIRD
single bird on branch
14"L x 11½"W, 1⅜" base
please specify right (shown) or left
270 Mahogany Rust with custom green* on leaves
pictured with pole 75RD

**please note: there is an upcharge for this custom finish; please refer to price list for details.*

SR1
smooth steel rings
1" ID, 1½" OD
270 Mahogany Rust

brackets

standard



L125
steel bracket, single
2" backplate, 2½" return

L125100
steel bracket, single
2½" backplate, 2½" return

L135
steel bracket, single
2" backplate, 3½" return

L135100
steel bracket, single
2½" backplate, 3½" return

L16
steel bracket, single
2½" backplate, 6" return



BKT075-100 **NEW**
adjustable steel bracket, single
3¼" backplate, 3¾"-5" return



EB1
steel eyelet bracket, single
3½" backplate, 3½" return,
eyelet 1"ID

EB2
steel eyelet bracket, single
3½" backplate, 6" return,
eyelet 1"ID

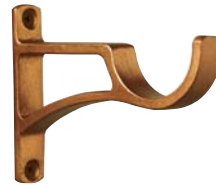

L235
steel bracket, single
3¾" backplate, 3½" return

L26
steel bracket, single
3¾" backplate, 6" return



L125SQ
steel square bracket, single
2½" backplate, 2½" return

L135SQ
steel square bracket, single
2½" backplate, 3½" return

*(square brackets above
are to be used with square
SRH75 pole)*



IM125
inside mount steel bracket
for poles ¾" to 1¼"Dia
1 ⅛" backplate, ¾"Deep, 1 ⅝"W



CSL125
steel bracket, single
2½"W x 1 ½"H backplate, 2 ⅝" return

CSL135
steel bracket, single
2½"W x 1 ½"H backplate, 3 ⅝" return

CSL16
steel bracket, single
2½"W x 1 ½"H backplate, 6" return

Return distance is from wall to center of cradle. All standard brackets are shown in 680 Aged Gold.

custom

The Finial Company is known for flexibility, especially in custom metal work. For more custom product options, see our **Custom Solutions** section beginning on page 5.



TBKT
custom steel t-bracket
please specify:
A. return (distance from wall to center of cradle)
B. pole size and profile
note: 3½"H backplate comes standard, unless otherwise specified



DBL1
custom steel double bracket
please specify:
A. front pole size and profile
B. back pole size and profile
C. rings to be used, if any
D. front and back returns (distance from wall to center of cradle)
note: returns are contingent upon which poles and rings are chosen
3½"H backplate comes standard, unless otherwise specified



BL4
custom steel ceiling mount bracket
please specify:
A. drop (distance from ceiling to top of pole)
B. pole size and profile
C. rings to be used, if any
note: minimum drop is contingent upon which finial and ring are chosen.
2½"W backplate comes standard, unless otherwise specified



FBKT
custom steel single bracket
please specify:
A. return (distance from wall to center of cradle)
B. pole size and profile
note: 4¾"H backplate may not be modified

Return or drop distance in excess of 8" on any custom bracket will incur additional fees and requires addition of support arm. Custom brackets are shown unfinished.

rings



SR1
smooth steel ring
1"ID, 1½"OD
680 Aged Gold



OVL3
oval smooth steel ring
1½"ID, 2"OD, 2½"L
680 Aged Gold



SQRG1
square smooth steel ring
1½"ID, 2½"OD
680 Aged Gold

poles

¾"
steel



75RD ¾"Dia solid steel pole, round
maximum length is 240 inches

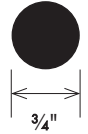

75HSRB ¾"Dia hammered solid steel pole, round
maximum length is 118 inches

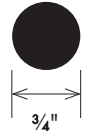

SRH75 ¾"Sq hammered solid steel pole, square
maximum length is 228 inches

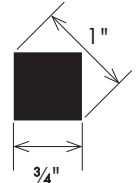

¾" steel poles are sold in 1 foot increments, 2 foot minimum.
Poles will be cut to specified length. Fall off will not be saved or shipped.

accessories



A



B

A SBTN
steel baton, paint only
¾"Dia
specify length up to 96"

B FBTN
fiberglass baton, white
¾"Dia
specify length up to 48"



125ELB
flexible elbow for connecting ½"-1¼" diameter poles
2"L (1¾"L when bent), 1¼" base

1" steel



SEC125 ES OH
 1/4"L x 1 1/4"W, 1 1/4" base
 105 Bronze
 pictured with pole RR100
*not for use with square pole
 1SQ or SHT1*



EC2
 1/4"L x 1 3/8"W, 1 3/8" base
 730 Rose Gold
 pictured with pole RR100



EC1
 1/4"L x 1 1/2"W, 1 1/2" base
 630 Ash Gray
 pictured with pole RR100



SQEC
 1/4"L x 1 1/8"SQ, 1 1/8" base
 109 Flat Black
 pictured with pole 1SQ
finial only fits 1SQ & SHT1 poles



SF230
 2 1/4"L x 2"W, 1 7/8" base
 700 Graphite
 pictured with pole ST3

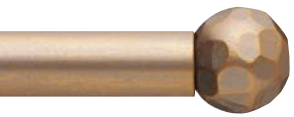

SF202A
 1 3/8"L x 1 3/8"W
 150 Gray with Gold
 pictured with pole RR100



SF202B
 2"L x 2"W
 640 Oil Rubbed Bronze
 pictured with pole RR100



SF237
 2 1/8"L x 1 5/8"W, 1 7/8" base
 100 Polished Steel
 pictured with pole ST3

**please note: there is an
 upcharge for this custom
 finish; please refer to price
 list for details.*



SF69 ES
 3 1/2"L x 2 1/2"W, 1 3/4" base
 330 Bronze with Black
 pictured with pole SRT1



SF133 ES
 2"L x 2 3/8"W, 1 1/4" base
 680 Aged Gold
 pictured with pole 1SQ



45834
 2 1/4"L x 1 1/4"W, 1 1/4" base
 110 Flat Black with Gold
 pictured with pole SHT1
*best suited for use with
 square pole 1SQ or SHT1*



SF201
 2 3/4"L x 1 5/8"W, 1 1/4" base
 630 Ash Gray
 pictured with pole SHT1



SF135
 2"L x 2"W, 1 3/8" base
 250 Platinum
 pictured with pole RR100



SF236
 3 1/4"L x 3"W, 1 3/8" base
 250B Platinum with Black
 pictured with pole RR100



K657 ES
 4"L x 2"W, 1 3/4" base
 110 Flat Black with Gold
 pictured with pole RR100



EC135 OH
 1 1/4"L x 2 1/8"W, 2" base
 110 Flat Black with Gold
 pictured with pole RR100

OH item is available in Outdoor Hardware, pages 78-80
ES item is available in Essential Sets, pages 74-75



SF180
3 7/8" L x 2" W, 1 3/4" base
730 Rose Gold
pictured with pole SRT1

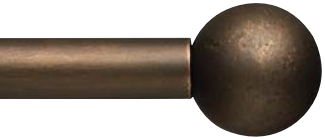

L9328
2" L x 2" W
106 Bronze with Gold
pictured with pole RR100

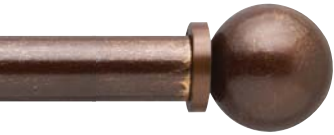

L9328B **NEW** **ES**
2 3/4" L x 2" W, 1 3/8" base
117 Walnut Gold
pictured with pole RR100



SF45
3" L x 2 1/2" W, 1 5/8" base
110 Flat Black with Gold
pictured with pole RR100

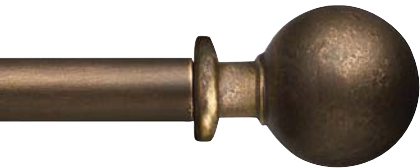

4519C **OH**
3 1/2" L x 2 1/2" W, 1 3/4" base
106 Bronze with Gold
pictured with pole RR100



SF1
3 3/8" L x 2 3/8" W, 1 5/8" base
126 Dark Walnut Gloss
with Gold
pictured with pole ST3



SF158B7
3" L x 2 3/4" W
106 Bronze with Gold
pictured with pole ST3



L651
5 1/8" L x 3 7/8" W, 1" base
110 Flat Black with Gold
pictured with pole RR100



L848 **OH**
7 1/2" L x 4 1/4" W, 1" base
110 Flat Black with Gold
pictured with pole RR100



SF22
5 1/4" L x 5" W, 2" base
please specify right (shown) or left
129B Antique Steel
with Black Highlights
pictured with pole ST2



SF222 **OH**
6 3/4" L x 3 3/4" W, 2" base
270 Mahogany Rust
pictured with pole RR100



SF98
6" L x 3 1/8" W, 1 7/8" base
250B Platinum with
Black Highlights
pictured with pole RR100



L885875
5 3/4" L x 3 3/4" W, 1 1/2" base
107 Bronze with Gold and Gray
pictured with pole SHT1

1"
steel



SF66
7"L x 5 3/4"W, 1 1/2" base
please specify right (shown) or left
129B Antique Steel
with Black Highlights
pictured with pole 1SQ



SF132
4 1/4"L x 4 3/4"W, 2" base
350G Statuary Bronze
with Gold
pictured with pole RR100



SF216
5 3/4"L x 6 3/8"W, 1 1/4" base
270 Mahogany Rust
pictured with pole RR100

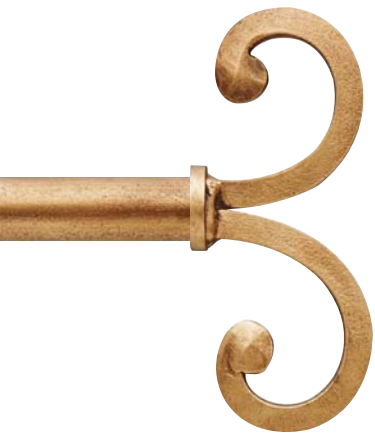

SF19
3 1/2"L x 6 3/4"W, 1 3/8" base
680 Aged Gold
pictured with pole RR100



SF205
8 1/4"L x 5 1/2"W, 1 1/4" base
please specify right (shown) or left
100 Polished Steel*
pictured with pole ST3

*please note: there is an
upcharge for this custom finish;
please refer to price list for
details.



SF21
6 1/2"L x 5 1/2"W, 1 1/4" base
please specify right (shown) or left
129B Antique Steel with
Black Highlights
pictured with pole ST3



SF59
7"L x 10 1/4"W, 1 1/2" base
please specify right (shown) or left
107 Bronze with Gold
and Gray
pictured with pole RR100



PBN

pine cone branch with needles
12½"L x 7"W, 1⅜" base
please specify right (shown) or left
106 Bronze with Gold
(needles are copper wire)
pictured with pole RR100

PB

pine cone branch (no needles)
12½"L x 7"W, 1⅜" base
available, not shown



Branch with Leaf

14"L x 10"W, 1⅜" base
please specify right (shown) or left
270 Mahogany Rust
with custom green* on leaves
pictured with pole ST3

**please note: there is an upcharge for this custom finish; please refer to price list for details.*



BIRD

single bird on branch
14"L x 11½"W, 1⅜" base
please specify right (shown) or left
270 Mahogany Rust
with custom green* on leaves
pictured with pole RR100

**please note: there is an upcharge for this custom finish; please refer to price list for details.*

brackets

standard



L125
steel bracket, single
2" backplate, 2¼" return

L125100
steel bracket, single
2½" backplate, 2" return

L16
steel bracket, single
2½" backplate, 6" return

L135
steel bracket, single
2" backplate, 3⅝" return

L135100
steel bracket, single
2⅜" backplate, 3½" return



BKT075-100 **NEW**
adjustable steel bracket, single
3¼" backplate, 3⅝"-5" return



L235
steel bracket, single
3⅝" backplate, 3½" return

L26
steel bracket, single
3⅝" backplate, 6" return



EB3
steel eyelet bracket, single
3½" backplate, 3½" return,
eyelet 1⅜"ID

EB4
steel eyelet bracket, single
3½" backplate, 6" return,
eyelet 1⅜"ID



L125SQ
steel square bracket, single
2½" backplate, 2½" return

L135SQ
steel square bracket, single
2½" backplate, 3½" return

(square brackets above are to be used with 1SQ and SHT1 square poles)



IM125
inside mount steel bracket
for poles ¾" to 1¼"Dia
1⅝" backplate, ¾"Deep, 1⅝"W



CSL125
steel bracket, single
2½"W x 1½"H backplate, 2⅝" return

CSL135
steel bracket, single
2½"W x 1½"H backplate, 3⅝" return

CSL16
steel bracket, single
2½"W x 1½"H backplate, 6" return

Return distance is from wall to center of cradle. All standard brackets are shown in 680 Aged Gold.

custom

The Finial Company is known for flexibility, especially in custom metal work. For more custom product options, see our **Custom Solutions** section beginning on page 5.



TBKT
custom steel t-bracket
please specify:
A. return (distance from wall to center of cradle)
B. pole size and profile
note: 3½"H backplate comes standard, unless otherwise specified



FBKT
custom steel single bracket
please specify:
1. return (distance from wall to center of cradle)
2. pole size and profile
note: 4¾"H backplate may not be modified



DBL1
custom steel double bracket
please specify:
A. front pole size and profile
B. back pole size and profile
C. rings to be used, if any
D. front and back returns (distance from wall to center of cradle)
note: returns are contingent upon which poles and rings are chosen
3½"H backplate comes standard, unless otherwise specified

Return or drop distance in excess of 8" on any custom bracket will incur additional fees and requires addition of support arm. Custom brackets are shown unfinished.



BL4
custom steel ceiling mount bracket
please specify:
A. drop (distance from ceiling to top of pole)
B. pole size and profile
C. rings to be used, if any
note: minimum drop is contingent upon which finial and ring are chosen.
2½"W backplate comes standard, unless otherwise specified



SCB35
single steel bypass bracket
3½" return



SCBCDBL
double steel bypass bracket
6" front return, 3" back return
use with:
CRSR3
steel C-ring
1½"ID x 2"OD
use with pole RR100

for more bypass bracket information, see page 7

rings



SR3
smooth steel ring
1½"ID, 2"OD

FSR1
heavy steel ring
1¾"ID, 2¾"OD

SQRG1
square smooth steel ring
1½"ID, 2½"OD

OVL3
oval smooth steel ring
1½"ID, 2"OD, 2½"L

CRSR3
steel C-ring
1½"ID x 2"OD
use with bypass
brackets and
pole RR100

OVL1
oval hammered steel ring
1¾"ID, 2½"OD, 3¼"L

all rings shown in 680 Aged Gold

poles

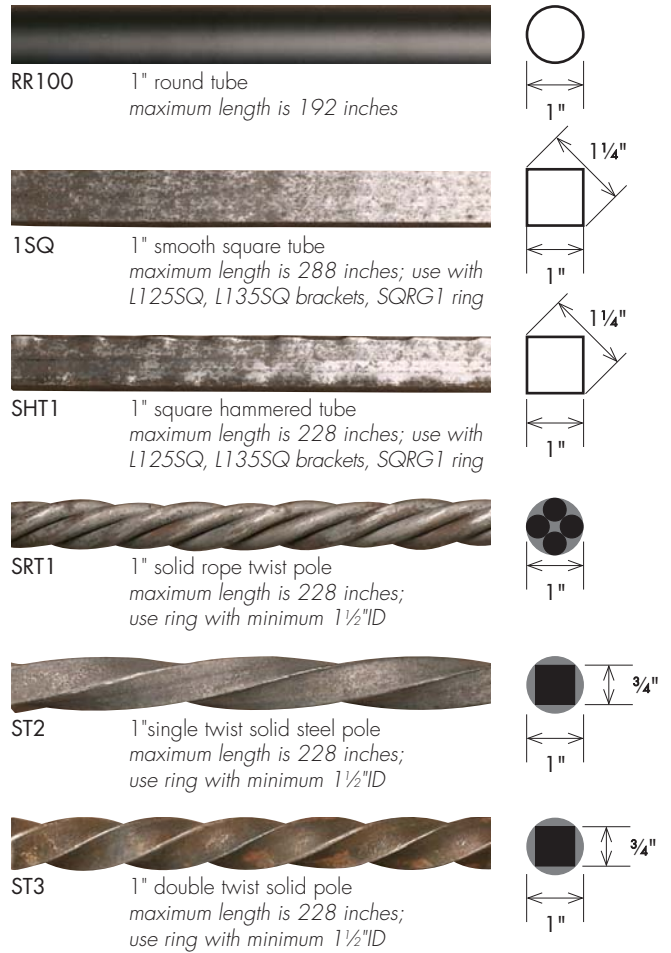

RR100 1" round tube
maximum length is 192 inches

1SQ 1" smooth square tube
maximum length is 288 inches; use with
L125SQ, L135SQ brackets, SQRG1 ring

SHT1 1" square hammered tube
maximum length is 228 inches; use with
L125SQ, L135SQ brackets, SQRG1 ring

SRT1 1" solid rope twist pole
maximum length is 228 inches;
use ring with minimum 1½"ID

ST2 1" single twist solid steel pole
maximum length is 228 inches;
use ring with minimum 1½"ID

ST3 1" double twist solid pole
maximum length is 228 inches;
use ring with minimum 1½"ID

1" steel poles are sold in 1 foot increments, 2 foot minimum. Poles will be cut to specified length. Fall off will not be saved or shipped.

accessories

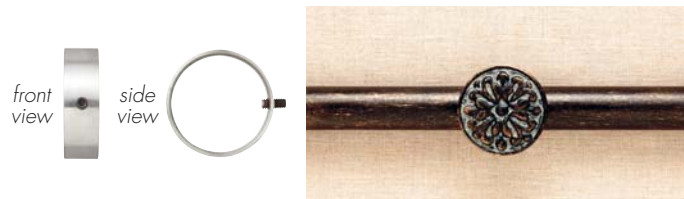

MB100
metal band, attaches any rosette to front of 1"Dia pole
use with 1" pole only
for more information on metal bands, see page 69



125ELB
flexible elbow for connecting ½"-1¼" diameter poles
2"L (1¾"L when bent), 1¼" base



- A WBTN**
wood baton, paint or stain
¾"Dia
specify length up to 48"
- B SBTN**
steel baton, paint only
¾"Dia
specify length up to 96"
- C FBTN**
fiberglass baton, white
¾"Dia
specify length up to 48"

1 1/4" steel



RF4
1"L x 1 7/8"W
110 Flat Black with Gold
pictured with pole RR125



EC135 OH
1 1/4"L x 2 1/8"W, 2" base
110 Flat Black with Gold
pictured with pole RR125



SEC125 OH
1/4"L x 1 1/4"W, 1 1/4" base
105 Bronze
pictured with pole RR125



SEC2 OH
1/4"L x 2"W, 2" base
106 Bronze with Gold
pictured with pole SRT2



EC1
1/4"L x 1 1/2"W, 1 1/2" base
630 Ash Gray
pictured with pole RR125



EC2
1/4"L x 1 3/8"W, 1 3/8" base
730 Rose Gold
pictured with pole RR125



L9328
2"L x 2"W
106 Bronze with Gold
pictured with pole RR125



SF133
2"L x 2 3/8"W, 1 1/4" base
770 Bronze Patina
pictured with pole RR125



SF230
2 1/4"L x 2"W, 1 7/8" base
610 Cobalt Bronze
pictured with pole RR125



SF237
2 1/8"L x 1 5/8"W, 1 7/8" base
330 Bronze with Black
pictured with pole RR125



SF4
3 1/2"L x 2 3/4"W, 2" base
110 Flat Black with Gold
pictured with pole RR125



SF63 OH
2 1/2"L x 2 1/2"W, 2" base
129 Antique Steel
pictured with pole RR125



3SF17
4 1/4"L x 2 3/4"W, 2" base
660 Antique White
pictured with pole RR125



SF131
4"L x 2 1/4"W, 2" base
110 Flat Black with Gold
pictured with pole RR125



SSA
4"L x 3 1/8"W, 2" base
106 Bronze with Gold
pictured with pole SRT2



K657
4"L x 2"W, 1 3/4" base
110 Flat Black with Gold
pictured with pole RR125

OH item is available in Outdoor Hardware, pages 78-80

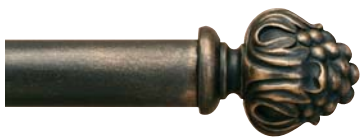

SF45
3"L x 2 1/2"W, 1 5/8" base
110 Flat Black with Gold
pictured with pole RR125



4519C OH
3 1/2"L x 2 3/4"W, 1 3/4" base
106 Bronze with Gold
pictured with pole RR125



SF98
6"L x 3 1/8"W, 1 7/8" base
250B Platinum with Black
pictured with pole TWCH125



SF222 OH
6 3/4"L x 3 3/4"W, 2" base
270 Mahogany/Rust
pictured with pole RR125



14R704
3 1/4"L x 2 1/4"W, 2 1/2" base
107 Bronze with Gold
and Gray
pictured with pole SRT2



SF138
4"L x 2 1/4"W, 2" base
350G Statuary Bronze with Gold
pictured with pole SRT2



SF70
5 1/4"L x 3"W, 2" base
270 Mahogany Rust
pictured with pole RR125

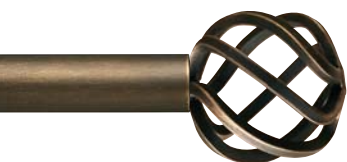

SF158B7
3"L x 2 3/4"W
106 Bronze with Gold
pictured with pole RR125



SF66
7"L x 5 3/4"W, 1 1/2" base
please specify right (shown) or left
660 Antique White
pictured with pole RR125



LS385 OH
5"L x 4 1/2"W
250B Platinum with
Black Highlights
pictured with pole TWCH125



SF132
4 1/4"L x 4 3/4"W, 2" base
350G Statuary Bronze with Gold
pictured with pole RR125



SF216
5 3/4"L x 6 5/8"W, 1 1/4" base
270 Mahogany Rust
pictured with pole RR125



SF22
5 1/4"L x 5"W, 2" base
please specify right (shown) or left
790 Vintage Bronze
pictured with pole RR125

1 1/4"
steel



SF21
6 1/2"L x 5 1/2"W, 1 3/8" base
please specify right (shown) or left
730 Rose Gold
pictured with pole SRT2



SF238
6 1/4"L x 4 1/4"W, 2" base
690 Champagne
pictured with pole RR125

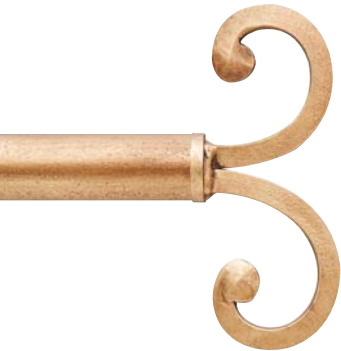

SF19
3 1/2"L x 6 3/4"W, 1 3/8" base
680 Aged Gold
pictured with pole RR125



SF20
4 1/2"L x 11 1/2"W, 2" base
110 Flat Black with Gold
pictured with pole TWCH125



SF59
7"L x 10 1/4"W, 1 3/8" base
please specify right (shown) or left
107 Bronze with Gold
and Gray
pictured with pole RR125



SF205
8 1/4"L x 5 1/2"W, 1 3/8" base
please specify right (shown) or left
610 Cobalt Bronze
pictured with pole RR125



SF92
6 1/4"L x 7 3/4"W, 2" base
110 Flat Black with Gold
pictured with pole RR125

SL3
custom steel leaf
attached to SR3 ring
(incurs additional fee)
2 1/4"L x 1 3/4"W
610 Cobalt Bronze
SR3 sold separately



SF96
4 1/4"L x 7"W, 2" base
250 Platinum
pictured with pole SRT2



SF141
8"L x 7 1/2"W, 2" base
please specify right (shown) or left
330 Bronze with Black
pictured with pole SRT2

custom solutions

Not sure what to do with an arched window? Our experienced custom metal shop can bend many of our steel poles into just the right shape.



See page 12 in Custom Solutions for more details....

rosettes and tiebacks

Looking for a steel rosette or tieback to complete your look? All rosettes and tiebacks can be found in the rosette section of our catalog, beginning on page 64.



brackets

standard



L125
steel bracket, single
2" backplate, 2 1/4" return

L125100
steel bracket, single
2 1/2" backplate, 2" return

L16
steel bracket, single
2 1/2" backplate, 6" return

L135
steel bracket, single
2" backplate, 3 3/8" return

L135100
steel bracket, single
2 3/8" backplate, 3 1/2" return



BKT118-138 NEW
adjustable steel bracket, single
3 1/4" backplate, 3 3/8"-4 7/8" return



L235
steel bracket, single
3 3/8" backplate, 3 1/2" return

L26
steel bracket, single
3 3/8" backplate, 6" return



EB3
steel eyelet bracket, single
3 1/2" backplate, 3 1/2" return,
eyelet 1 3/8" ID

EB4
steel eyelet bracket, single
3 1/2" backplate, 6" return,
eyelet 1 3/8" ID



IM125
inside mount steel bracket
for poles 3/4" to 1 1/4" Dia
1 1/8" backplate, 3/4" Deep, 1 5/8" W



CSL125
steel bracket, single
2 1/2"W x 1 1/2"H backplate, 2 5/8" return

CSL135
steel bracket, single
2 1/2"W x 1 1/2"H backplate, 3 3/8" return

CSL16
steel bracket, single
2 1/2"W x 1 1/2"H backplate, 6" return

Return distance is from wall to center of cradle. All standard brackets are shown in 680 Aged Gold.

custom

The Finial Company is known for flexibility, especially in custom metal work. For more custom product options, see our **Custom Solutions** section beginning on page 5.



TBKT
custom steel t-bracket
please specify:
A. return (distance from wall to center of cradle)
B. pole size and profile
note: 3 1/2"H backplate comes standard, unless otherwise specified



FBKT
custom steel single bracket
please specify:
1. return (distance from wall to center of cradle)
2. pole size and profile
note: 4 3/4"H backplate may not be modified



DBL1
custom steel double bracket
please specify:
A. front pole size and profile
B. back pole size and profile
C. rings to be used, if any
D. front and back returns (distance from wall to center of cradle)
note: returns are contingent upon which poles and rings are chosen
3 1/2"H backplate comes standard, unless otherwise specified



BL4
custom steel ceiling mount bracket
please specify:
A. drop (distance from ceiling to top of pole)
B. pole size and profile
C. rings to be used, if any
note: minimum drop is contingent upon which finial and ring are chosen.
2 1/2"W backplate comes standard, unless otherwise specified

Return or drop distance in excess of 8" on any custom bracket will incur additional fees and requires addition of support arm. Custom brackets are shown unfinished.



SCB35
single steel bypass bracket
3 1/2" return



SCBCDBL
double steel bypass bracket
6" front return, 3" back return

use with:
CRSR7
steel C-ring
2 1/4" ID x 2 3/4" OD
use with pole RR125

for more bypass bracket information, see page 7

rings



SR3
smooth steel ring
1½"ID, 2"OD

FSR1
heavy steel ring
1¾"ID, 2¾"OD

HSR1
hammered steel ring
1¾"ID, 2½"OD

OVL3
oval smooth steel ring
1½"ID, 2"OD, 2½"L

CRSR7
steel C-ring
2¼"ID, 2¾"OD
use only with
bypass brackets
and pole RR125

OVL1
oval hammered steel ring
1¾"ID, 2½"OD, 3¼"L

all rings shown in 680 Aged Gold

poles

1¼" steel



RD125

1¼" round tube, heavy walled
maximum length is 252 inches

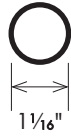

RR125

1¼" round tube
maximum length is 192 inches

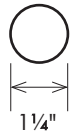

SRT2

1¼" solid rope
maximum length is 228 inches
use ring with minimum 1¾"ID



TWCH125

1¼" twisted channel
maximum length is 180 inches
use ring with minimum 1¾"ID



1¼" steel poles are sold in 1 foot increments, 2 foot minimum. Poles will be cut to specified length. Fall off will not be saved or shipped.

accessories



- A WBTN**
wood baton, paint or stain
¾"Dia
specify length up to 48"
- B SBTN**
steel baton, paint only
¾"Dia
specify length up to 96"
- C FBTN**
fiberglass baton, white
¾"Dia
specify length up to 48"



125ELB
flexible elbow for connecting ½"-1¼" diameter poles
2'L (1¾"L when bent), 1¼" base

1½ - 1¾"

steel



EC3
¾"L x 2"W, 2" base
700 Graphite
pictured with pole RR175



SEC2 OH
¼"L x 2"W, 2" base
106 Bronze with Gold
pictured with pole TRT



FC1
1¼"L x 2¾"W, 2¾" base
110 Flat Black with Gold
pictured with pole RR175



SF192
4¾"L x 2¾"W, 2½" base
760 Rustic Iron
pictured with pole RR175



SF138
4"L x 2¼"W, 2" base
350G Statuary Bronze with Gold
pictured with pole TRT



SF90
3¾"L x 3"W, 2½" base
110 Flat Black with Gold
pictured with pole RR175



SF4
3½"L x 2¾"W, 2" base
110 Flat Black with Gold
pictured with pole RR175



SF150
3¼"L x 2½"W, 2¼" base
250B Platinum with Black Highlights
pictured with pole TRT



SF63 OH
2½"L x 2½"W, 2" base
129 Antique Steel
pictured with pole RR175



SF151 OH
3½"L x 2½"W, 2½" base
110 Flat Black with Gold
pictured with pole RR175



3SF17
4¼"L x 2¾"W, 2" base
110 Flat Black with Gold
pictured with pole RR175



SF17
5½"L x 3¾"W, 2" base
110 Flat Black with Gold
pictured with pole RR175



SF134
5½"L x 2¾"W, 2½" base
112 Silver with Gold
pictured with pole RR175

OH item is available in Outdoor Hardware, pages 78-80



SF70
5¼"L x 3"W, 2" base
270 Mahogany Rust
pictured with pole RR175



SF235
4¾"L x 3"W, 2½" base
110 Flat Black with Gold
pictured with pole RR175



L651+FC1
6¾"L x 3¾"W, 2¾" base
110 Flat Black with Gold
pictured with pole RR175



L848+FC1 **OH**
8¾"L x 4¼"W, 2¾" base
110 Flat Black with Gold
pictured with pole RR175



SF100
5¾"L x 2½"W, 2½" base
105 Bronze
pictured with pole RD175



LS385 **OH**
5"L x 4½"W
250B Platinum with
Black Highlights
pictured with pole RR175



LS385+FC1
6¼"L x 4½"W, 2¾" base
250B Platinum with
Black Highlights
pictured with pole TRT



SF238
6¼"L x 4¼"W, 2" base
250B Platinum with
Black Highlights
pictured with pole TRT



SF50
6¼"L x 3"W, 2¼" base
250B Platinum with
Black Highlights
pictured with pole RR175

1 1/2 - 1 3/4"

steel



SF152
7 1/4"L x 3 3/4"W, 2 1/4" base
330 Bronze with Black
pictured with pole TRT



SF137
5 7/8"L x 2 7/8"W, 3" base
129 Antique Steel
pictured with pole TWCH



SF8
3 1/2"L x 3"W, 2" base
270 Mahogany Rust
pictured with pole TWCH

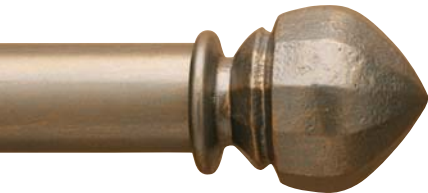

SF140
3 5/8"L x 2 3/4"W, 2 1/8" base
150 Gray with Gold
pictured with pole RR175



1330HBL
2 3/4"Dia
110 Flat Black with Gold
pictured with pole RR175



1340HB
3 3/4"Dia
110 Flat Black with Gold
pictured with pole RR175



SF218
5 7/8"L x 6"W, 6" base
640 Oil Rubbed Bronze
pictured with pole RR175

please note: finial base is recessed and covers 1 1/2" of pole. Be sure to add 3" to total pole length to compensate.

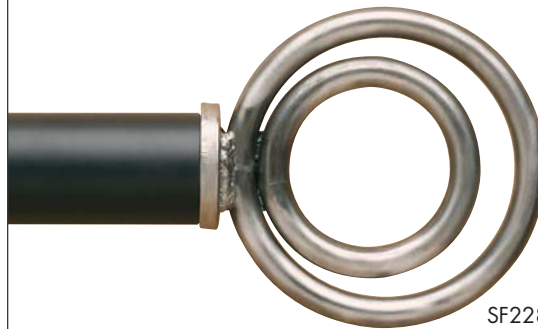

SF228
5 1/8"L x 4 7/8"W, 2" base
100 Polished Steel*
pictured with pole RR175
109 Flat Black

**please note: there is an upcharge for this custom finish; please refer to price list for details.*

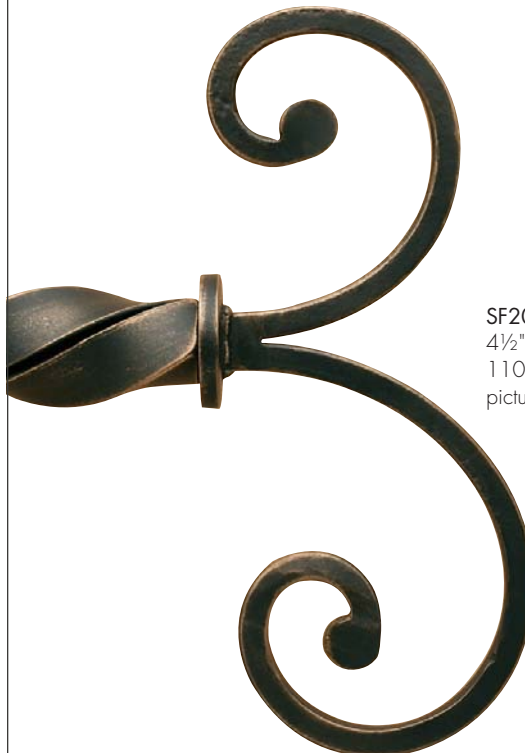

SF20
4 1/2"L x 11 1/2"W, 2" base
110 Flat Black with Gold
pictured with pole TWCH



SF14+FC1
6½"L x 8¾"W, 2⅜" base
please specify right (shown) or left
110 Flat Black with Gold
pictured with pole TRT



SF92
6¼"L x 7¾"W, 2" base
110 Flat Black with Gold
pictured with pole RR175



SF22
5¼"L x 5"W, 2" base
please specify right (shown) or left
790 Vintage Bronze
pictured with pole RR175



SF96
4¼"L x 7"W, 2" base
250 Platinum
pictured with pole TRT



SF141
8"L x 7½"W, 2" base
please specify right (shown) or left
330 Bronze with Black
pictured with pole TRT

custom solutions

Did you know we can miter nearly any steel pole? Whether you need a mitered return or a bay window solution, our experienced custom metal shop can make it for you.



For more details on miters, see page 9 in Custom Solutions.

1 1/2 - 1 3/4"

steel

brackets

standard



BKT112-134 **NEW**
adjustable steel bracket, single
3 1/2" backplate, 3 7/8"-5 1/8" return



A17535
steel bracket, single
2 1/2" backplate, 3 1/2" return



B17535
steel bracket, single
3 5/8" backplate, 3 1/2" return



EB5
steel eyelet bracket, single
3 1/2" backplate, 3 1/2" return,
eyelet 1 7/8" ID



CS17535
steel bracket, single
2 1/2"W x 1 1/2"H backplate, 3 1/2" return



IM175
inside mount steel bracket
for poles 1 3/8" to 1 3/4" Dia
1 1/2"H x 3/4" Deep, 2 1/4"W

EB6
steel eyelet bracket, single
3 1/2" backplate, 6" return,
eyelet 1 7/8" ID

CS1756
steel bracket, single
2 1/2"W x 1 1/2"H backplate, 6" return

Return distance is from wall to center of cradle. All standard brackets are shown in 680 Aged Gold.

custom

The Finial Company is known for flexibility, especially in custom metal work. For more custom product options, see our **Custom Solutions** section beginning on page 5.



TBKT
custom steel t-bracket
please specify:
A. return (distance from wall to center of cradle)
B. pole size and profile
note: 3 1/2"H backplate comes standard, unless otherwise specified



DBL1
custom steel double bracket
please specify:
A. front pole size and profile
B. back pole size and profile
C. rings to be used, if any
D. front and back returns (distance from wall to center of cradle)
note: returns are contingent upon which poles and rings are chosen
3 1/2"H backplate comes standard, unless otherwise specified



BL4
custom steel ceiling mount bracket
please specify:
A. drop (distance from ceiling to top of pole)
B. pole size and profile
C. rings to be used, if any
note: minimum drop is contingent upon which finial and ring are chosen.
2 1/2"W backplate comes standard, unless otherwise specified



SCB35
single steel bypass bracket
3 1/2" return



SCBCDBL
double steel bypass bracket
6" front return, 3" back return



FBKT
custom steel single bracket
please specify:
1. return (distance from wall to center of cradle)
2. pole size and profile
note: 4 3/4"H backplate may not be modified

Return or drop distance in excess of 8" on any custom bracket will incur additional fees and requires addition of support arm. Custom brackets are shown unfinished.

use with:
CRSR12
steel C-ring
2 1/2" ID x 3" OD
use with pole RR175

for more bypass bracket information, see page 7

accessories



A WBTN
wood baton, paint or stain
3/8" Dia
specify length up to 48"

B SBTN
steel baton, paint only
3/8" Dia
specify length up to 96"

C FBTN
fiberglass baton, white
3/8" Dia
specify length up to 48"



SELB
flexible wood elbow for 1 3/8"-1 3/4" diameter poles
2 3/4" L overall (2 1/4" L when bent), 1 3/4" base

poles

1 1/2 - 1 3/4" steel



RR175 1 3/4" Dia round tube
maximum length is 192 inches

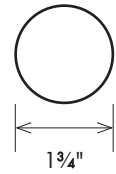

RD175 1 3/4" Dia round tube, heavy walled
maximum length is 288 inches

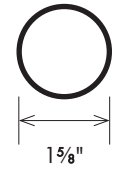

TRT 1 1/2" Dia twisted tube
maximum length is 216 inches
use ring with minimum 2" ID

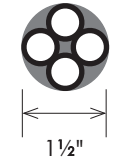

TWCH 1 3/4" Dia twisted channel
maximum length is 180 inches
use ring with minimum 2 3/8" ID



1 1/2"-1 3/4" steel poles are sold in 1 foot increments, 2 foot minimum.
Poles will be cut to specified length. Fall off will not be saved or shipped.

rings



SR7
smooth steel ring
2 1/4" ID, 2 3/4" OD



FSR2
heavy steel ring
2" ID, 3" OD



SR5
twisted steel ring
2 1/2" ID, 3" OD



HSR175
hammered steel ring
2" ID, 2 3/4" OD



CRSR12
steel C-ring
2 1/2" ID, 3" OD
only use with
bypass brackets
and pole RR175



DRRG3
leafy resin ring
3" ID, 4 1/2" OD



WWRG
fluted wood ring
2 3/8" ID, 3 3/8" OD



OVL175
oval hammered steel ring
2" ID, 2 3/4" OD, 3 1/2" L



OVL7
oval smooth steel ring
2 1/4" ID, 2 3/4" OD, 3 1/2" L

Our Steel Products look great in every finish, but here are a few that our expert hand finishing team recommends specifically for steel products:



110 Flat Black with Gold



250 Platinum



106 Bronze with Gold



129 Antique Steel

Wishing for the convenience and cost-savings of a complete Steel drapery hardware set?
Check out 1" Essential Sets on page 74 in Special Collections.



K657SET in 117 Walnut Gold

Can't find our sleek Modern Collection? See pages 76-77 in Special Collections.



SG120-1 finial in Brushed Nickel, ML100-GM pole, SG500 rings in Brushed Nickel



wood and resin

1 3/8" diameter products	42
2"-2 1/4" diameter products	46
3" diameter products	58
rosettes, tiebacks and crests	64

1 3/8"
2" - 2 1/4"
3"

1 3/8"

actual pole sizes

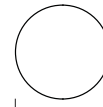
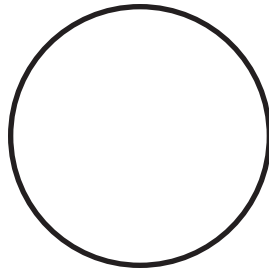

1 3/8"
WS38



1 3/8"
WR38

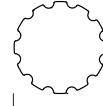

1 3/8"
WG38



1 3/8"
WNF38

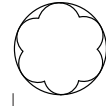

1 3/8"
138TW

2" - 2 1/4"

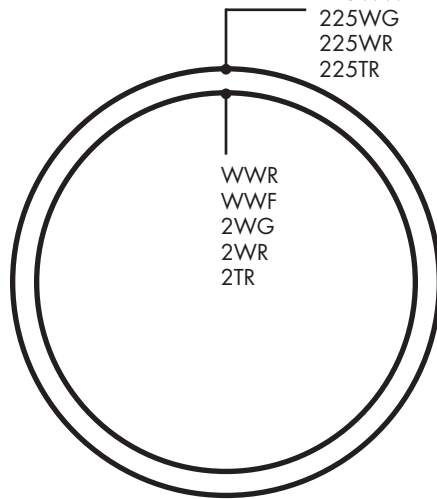

225WS
225FL
225WWR
225WG
225WR
225TR

WWR
WWF
2WG
2WR
2TR

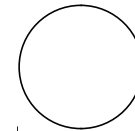

WWR 2"
225WS 2 1/4"

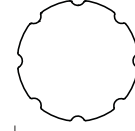

WWF 2"
225FL 2 1/4"

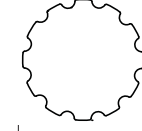

2WG 2"
225WG 2 1/4"



2WR 2"
225WR 2 1/4"

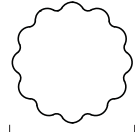

225WWR 2 1/4"

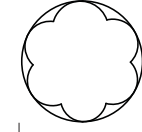

2TR 2"
225TR 2 1/4"

3"

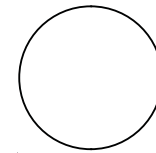
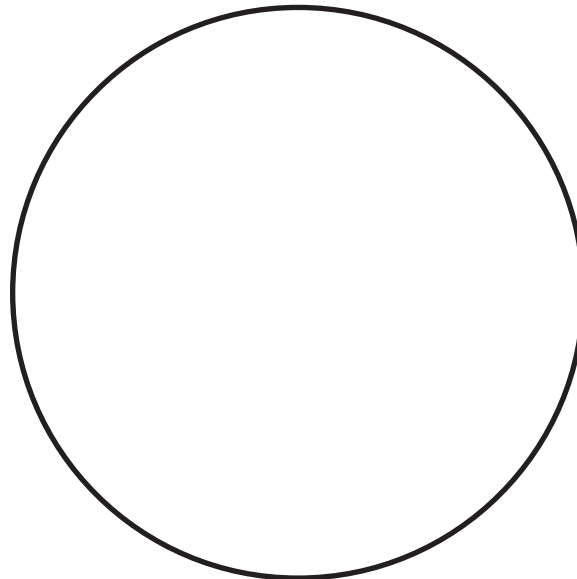

3"
3SM

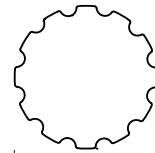

3"
3GR



3"
3RD

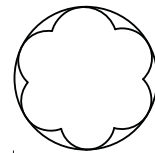

3"
3TR



wood and resin

Carved wood evokes timeless tradition. Modern resin allows even broader design capability. Combining these materials provides endless design variation. The Finial Company offers the familiar classics you need and the transitional new favorites you desire.

1 3/8"

wood and resin



F138-9 **NEW**
3/8"L x 2 1/8"W, 1 7/8" base
640 Oil Rubbed Bronze
pictured with pole WS38



RF5
1"L x 1 3/4"W, 1 3/8" base
107 Bronze with Gold
and Gray
pictured with pole WG38



F138-3 **NEW**
4"L x 3"W, 1 7/8" base
660 Antique White
pictured with pole WNF38



F138-2 **NEW**
4 7/8"L x 3 1/8"W, 1 7/8" base
620 Weathered Iron
pictured with pole 138TW



F138-1 **NEW**
4 7/8"L x 2 7/8"W, 2" base
610 Cobalt Bronze
pictured with pole VWR38



F138-8 **NEW**
3 1/4"L x 3"W, 1 7/8" base
650 Hickory
pictured with pole WS38



F138-7 **NEW**
3 5/8"L x 3 1/4"W, 1 7/8" base
630 Ash Gray
pictured with pole WG38

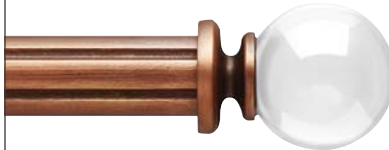

F138-5C **NEW**
3 1/4"L x 2 1/2"W, 1 7/8" base
730 Rose Gold
pictured with pole WNF38

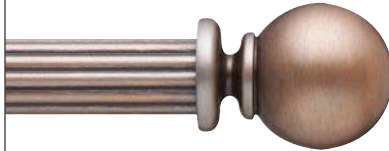

F138-5S **NEW**
3 1/4"L x 2 1/2"W, 1 7/8" base
760 Rustic Iron
pictured with pole WR38



F138-4C **NEW**
3 1/4"L x 3 3/4"W (2 5/8" Sq), 1 7/8" base
740 Smoky Mocha
pictured with pole WS38

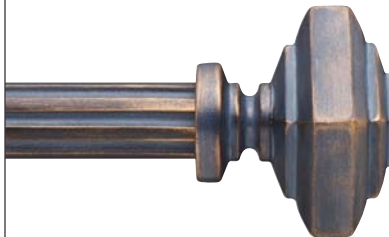

F138-4S **NEW**
3 1/4"L x 3 3/4"W (2 5/8" Sq), 1 7/8" base
790 Vintage Bronze
pictured with pole WG38

Need a 1 3/8" wood pole longer than 12' ?

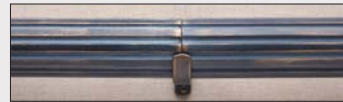

Join two poles with a connector screw. Ask for one with your order. Be sure to position a support bracket at the connection.



F138-6 **NEW**
3 1/4"L x 3 1/2"W, 1 7/8" base
600 Gilded Red
pictured with pole WS38



WW190
4 1/4"L x 2 1/2"W, 1 3/4" base
610 Cobalt Bronze
pictured with pole WNF38



RF3
4 1/2"L x 3 7/8"W, 2" base
710 Tarnished Silver
pictured with pole WR38



GB4
4"L x 2 1/2"W, 1 3/4" base
109 Flat Black
pictured with pole WS38

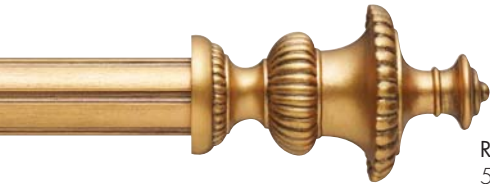

RF86
5"L x 3"W, 1 3/4" base
750 Polished Gold
pictured with WNF38



407
6"L x 3 1/4"W, 2 1/8" base
790 Vintage Bronze
pictured with WG38

wood finials



138EC
1 1/4"L x 2 7/8"W
240 Walnut
pictured with pole WS38



38EC
1 3/8"L x 1 7/8"W, 1 3/4" base
780 Hazelwood
pictured with pole WG38



387
3"L x 2 3/8"W, 1 7/8" base
720 Tawny Oak
pictured with pole WNF38



386
4"L x 2 1/4"W, 1 3/4" base
670 Espresso
pictured with pole WG38

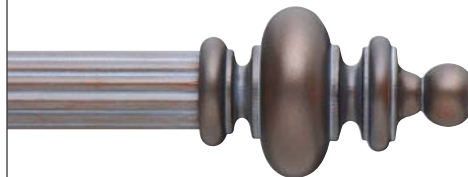

385
4 1/2"L x 3"W, 1 7/8" base
740 Smoky Mocha
pictured with pole WR38



384
4 3/4"L x 2 1/4"W, 1 3/4" base
650 Hickory
pictured with pole WS38

1 3/8"

wood and resin

brackets

standard



38B
wood bracket, single
4 1/8" backplate, 2 1/4" return

WWB3 **NEW**
wood bracket, single
4 1/4" backplate, 3 1/2" return



BKT118-138 **NEW**
adjustable steel bracket, single
3 1/4" backplate, 3 3/8"-4 7/8" return



EB5
steel eyelet bracket, single
3 1/2" backplate, 3 1/2" return,
eyelet 1 7/8" ID

EB6
steel eyelet bracket, single
3 1/2" backplate, 6" return,
eyelet 1 7/8" ID



38EB3
wood bracket, single
2" backplate, 3 1/2" return

38EB5
wood bracket, single
2 1/4" backplate, 6 1/2" return



A17535
steel bracket, single
2 1/2" backplate, 3 1/2" return

A1756
steel bracket, single
2 1/2" backplate, 6" return



CS17535
steel bracket, single
2 1/2"H x 1 1/2"H backplate, 3 1/2" return

CS1756
steel bracket, single
2 1/2"H x 1 1/2"H backplate, 6" return



38ISM
inside mount wood bracket
deduct 1" from total pole
length



B17535
steel bracket, single
3 5/8" backplate, 3 1/2" return

B1756
steel bracket, single
3 5/8" backplate, 6" return



IM175
inside mount steel bracket
for poles up to 1 3/8"-1 3/4" Dia
1 1/2" backplate, 3/4" deep, 2 1/4"W

Return distance is from wall to center of cradle. All standard steel brackets are shown in 680 Aged Gold.

custom

The Finial Company is known for flexibility, especially in custom metal work. For more custom product options, see our **Custom Solutions** section beginning on page 5.



TBKT
custom steel t-bracket
please specify:
A. return (distance from wall to center of cradle)
B. pole size and profile
note: 3 1/2"H backplate comes standard, unless otherwise specified



DBL1
custom steel double bracket
please specify:
A. front pole size and profile
B. back pole size and profile
C. rings to be used, if any
D. front and back returns (distance from wall to center of cradle)
note: returns are contingent upon which poles and rings are chosen
3 1/2"H backplate comes standard, unless otherwise specified



BL4
custom steel ceiling mount bracket
please specify:
A. drop (distance from ceiling to top of pole)
B. pole size and profile
C. rings to be used, if any
note: minimum drop is contingent upon which finial and ring are chosen.
2 1/2"W backplate comes standard, unless otherwise specified



FBKT
custom steel single bracket
please specify:
A. return (distance from wall to center of cradle)
B. pole size and profile
note: 4 3/4"H backplate may not be modified

Return or drop distance in excess of 8" on any custom bracket will incur additional fees and requires addition of support arm. Custom brackets are shown unfinished.

rings



SR13
smooth steel ring
1 3/4"ID, 2 1/4"OD

FSR1
heavy steel ring
1 3/4"ID, 2 3/4"OD

38FLR
ribbed wood ring
1 3/4"ID, 2 7/8"OD

HSR1
hammered steel ring
1 3/4"ID, 2 1/2"OD

OVL3
oval smooth steel ring
1 1/2"ID, 2"OD, 2 1/2"L

OVL1
oval hammered steel ring
1 3/4"ID, 2 1/2"OD, 3 1/4"L

poles

1 3/8"
wood and resin



WS38 1 3/8" smooth wood

WG38 1 3/8" grooved wood

WNF38 1 3/8" fluted wood

WR38 1 3/8" reeded wood

138TW 1 3/8" twisted wood

1 3/8" wood poles are sold in 2 foot increments, 2 foot minimum. Poles will be cut to specified length. Fall off will not be saved or shipped. Maximum length of all 1 3/8" wood poles is 144".

accessories



MB138
metal band, attaches any rosette to front of 1 3/8" Dia pole
use with 1 3/8" pole only
for more information on metal bands, see page 69



*MB138 band, R24 rosette, WS38 pole,
finish 200 Walnut Gold with Gray Accents*



SELB
flexible wood elbow for connecting 1 3/8" wood poles
2 3/4"L (2 1/4"L when bent), 1 3/4" base



- A WBTN**
wood baton, paint or stain
3/8" Dia
specify length up to 48"
- B SBTN**
steel baton, paint only
3/8" Dia
specify length up to 96"
- C FBTN**
fiberglass baton, white
3/8" Dia
specify length up to 48"
- D EPBTN1**
wood baton, paint or stain
5/8" Dia, handle: 6 1/8" L x 1 1/4" Dia
specify length up to 48"
- E EPBTN2**
wood baton, paint or stain
5/8" Dia, handle: 5 3/4" L x 1 1/2" Dia
specify length up to 48"

2-2¹/₄"

wood and resin

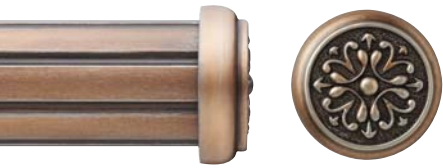

REC73
 7/8"L x 2³/₄"W, 2³/₄" base
 760 Rustic Iron
 pictured with pole 225FL



EC214-1 **NEW**
 1³/₈"L x 2⁷/₈"W, 2⁷/₈" base
 600 Gilded Red
 pictured with pole 225WG



F214-12 **NEW**
 2"L x 3"W, 2⁷/₈" base
 660 Antique White
 pictured with pole 225WR



F214-2 **NEW**
 2¹/₄"L x 3¹/₂"W, 3" base
 610 Cobalt Bronze
 pictured with pole 225WG
coordinates with rosette ROS3



F214-3 **NEW**
 3³/₄"L x 4"W, 2⁷/₈" base
 107 Bronze with Gold
 and Gray
 pictured with pole 225FL
coordinates with rosette ROS3



F214-4 **NEW**
 2⁷/₈"L x 3¹/₂"W, 2³/₄" base
 640 Oil Rubbed Bronze
 pictured with pole 225WS

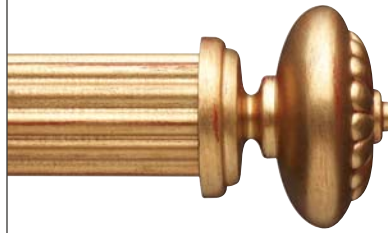

F214-1 **NEW**
 3¹/₂"L x 4"W, 2⁷/₈" base
 600 Gilded Red
 pictured with pole 225WWR

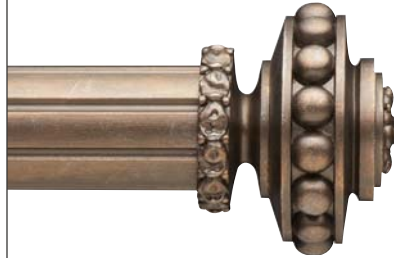

F214-7 **NEW**
 3⁵/₈"L x 4¹/₂"W, 3" base
 690 Champagne
 pictured with pole 225FL

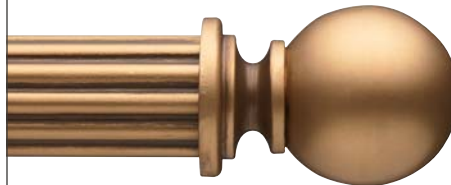

F214-8 **NEW**
 4³/₈"L x 3¹/₄"W, 2⁷/₈" base
 680 Aged Gold
 pictured with pole 225WWR

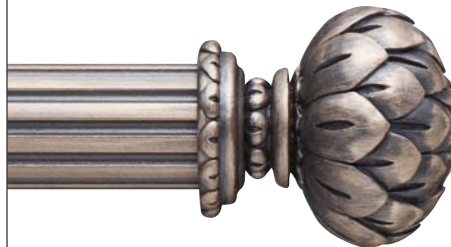

F214-9 **NEW**
 4³/₄"L x 4³/₈"W, 3¹/₈" base
 700 Graphite
 pictured with pole 225WG

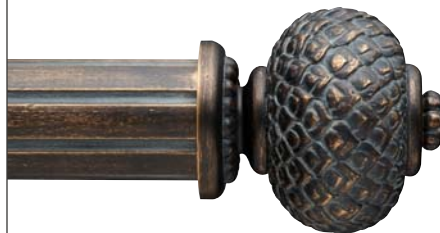

F214-10 **NEW**
 4¹/₂"L x 4¹/₈"W, 3" base
 620 Weathered Iron
 pictured with pole 225FL



F214-11 **NEW**
 4⁷/₈"L x 4"D, 2⁷/₈" base
 630 Ash Gray
 pictured with pole 225WS



F214-6 **NEW**
5¹/₂"L x 4"W, 2⁷/₈" base
670 Espresso
pictured with pole 225TR



F214-5 **NEW**
7"L x 4³/₄"W, 3" base
620 Weathered Iron
pictured with pole 225WWR
coordinates with rosette ROS5



F214-13 **NEW**
4"L x 4¹/₈"W, 2⁷/₈" base
790 Vintage Bronze
pictured with pole 225WR



F214-14 **NEW**
4⁷/₈"L x 3¹/₂"W, 2⁷/₈" base
640 Oil Rubbed Bronze
pictured with pole 225WG

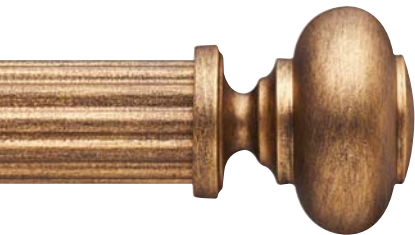

F214-15S **NEW**
4"L x 4¹/₈"W, 2⁷/₈" base
155 Antique
pictured with pole 225WWR
coordinates with rosette ROS1S



F214-15C **NEW**
4"L x 4¹/₈"W, 2⁷/₈" base
106 Bronze with Gold
pictured with pole 225WS
coordinates with rosette ROS1C



F214-16S **NEW**
3⁵/₈"L x 4¹/₈"W (3"Sq), 2⁷/₈" base
350G Statuary Bronze
with Gold
pictured with pole 225WS
coordinates with rosette ROS6S



F214-16C **NEW**
3⁵/₈"L x 4¹/₈"W (3"Sq), 2⁷/₈" base
630 Ash Gray
pictured with pole 225WG
coordinates with rosette ROS6C



RF1000
7¹/₄"L x 3"W, 4" base
780 Hazelwood
pictured with pole 225FL



GB2
5¹/₄"L x 3³/₈"W, 2¹/₂" base
250 Platinum
pictured with pole WWR



WW200
6³/₄"L x 4¹/₂"W, 2¹/₂" base
670 Espresso
pictured with pole 225WR



WW51
5¹/₂"L x 4"W, 2¹/₂" base
200 Walnut Gold
with Gray Accents
pictured with pole 225WG

2-2 1/4"

wood and resin



Y10
7"L x 3 3/4"W, 2 1/2" base
107 Bronze with Gold and Gray
pictured with pole 225WG



RF63
3"L x 2 3/4"W, 2 1/2" base
610 Cobalt Bronze
pictured with pole 225WS
coordinates with rosette RF63R



WW29
8 1/4"L x 3"W, 2 1/2" base
700 Graphite
pictured with pole 225WS



R22575
6"L x 3 1/4"W, 2 1/2" base
200 Walnut Gold with Gray
pictured with pole 225WG



R2400
6"L x 3"W, 2 1/2" base
740 Smoky Mocha
pictured with pole 225FL



225MC15
5 1/2"L x 4"W, 2 1/2" base
670 Espresso
pictured with pole 225WWR



R22569 ES
6"L x 3 1/2"W, 2 1/2" base
650 Hickory
pictured with pole 225WS



RFVB
6 1/2"L x 3"W, 2 1/2" base
620 Weathered iron
pictured with pole 225WR



GB1 ES
5"L x 3"W, 2 1/2" base
109 Flat Black
pictured with pole WWR

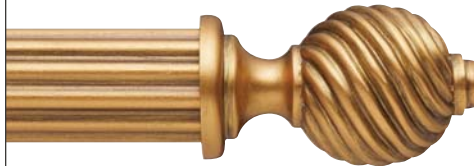

WW201
5"L x 2 3/4"W, 2 3/4" base
750 Polished Gold
pictured with pole 225WWR



RF10
6 1/2"L x 3 1/2"W, 2 3/4" base
200 Walnut Gold with Gray
pictured with pole 2WR



225MC11
4"L x 5"W, 2 1/2" base
107 Bronze with Gold and Gray
pictured with pole 225WR
coordinates with rosette RMC11

ES item is available in Essential Sets, pages 74-75



LF225
6¹/₈"L x 2¹/₂"W, 2¹/₂" base
760 Rustic Iron
pictured with pole 225WG



WW24
7"L x 4"W, 2¹/₂" base
107 Bronze with
Gold and Gray
pictured with pole 225WG



WW47
5³/₄"L x 3¹/₂"W, 2¹/₂" base
720 Tawny Oak
pictured with pole 225FL



225MC6
5"L x 4¹/₄"W, 2³/₄" base
106 Bronze with Gold
pictured with pole 225WWR

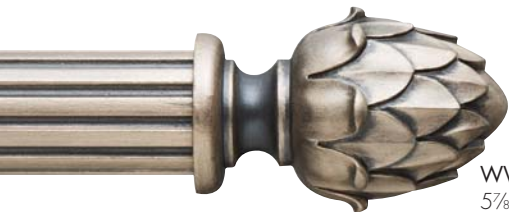

WW207
5⁷/₈"L x 3³/₄"W, 2¹/₂" base
710 Tarnished Silver
pictured with pole 225WG

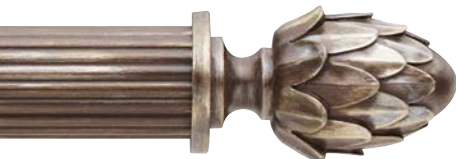

WW19
5⁷/₈"L x 3³/₄"W, 2¹/₄" base
770 Bronze Patina
pictured with pole 2WR



225MC13
3³/₄"L x 4⁷/₈"W, 2¹/₂" base
640 Oil Rubbed Bronze
pictured with pole 225WWR
coordinates with rosette RMC13



WW60
2⁷/₈"L x 3¹/₂"W, 3¹/₂" base
660 Antique White
pictured with pole 225WG
coordinates with rosette WD60



WW205
4"L x 3¹/₂"W, 2¹/₂" base
670 Espresso
pictured with pole 225WS



WW4
5¹/₄"L x 3¹/₄"W, 2¹/₂" base
730 Rose Gold
pictured with pole WWF



WW3
5¹/₄"L x 3"W, 2³/₄" base
740 Smoky Mocha
pictured with pole 225FL



225RF90
5³/₄"L x 3¹/₂"W, 2¹/₂" base
610 Cobalt Bronze
pictured with pole 225WWR

2-2¹/₄"
wood and resin



WW70
6¹/₂"L x 5¹/₄"W, 2¹/₂" base
610 Cobalt Bronze
pictured with pole 225WR
coordinates with rosette R8

WW10
5⁷/₈"L x 3¹/₂"W, 2¹/₂" base
330 Bronze with Black
pictured with pole 225WWR



WW35
6¹/₂"L x 4³/₄"W, 2³/₄" base
690 Champagne
pictured with pole 225FL



WW11
5³/₈"L x 3¹/₄"W, 2⁷/₈" base
155 Antique
pictured with pole 2WR



225LGFT
5¹/₄"L x 4"W, 2⁷/₈" base
155 Antique
pictured with pole 225TR



225RF86
6"L x 3³/₄"W, 2¹/₂" base
630 Ash Gray
pictured with pole 225WS



RF92
5¹/₂"L x 3"W, 2¹/₂" base
620 Weathered Iron
pictured with pole 2WG



225MC9
4³/₈"L x 4¹/₄"W, 2¹/₂" base
600 Gilded Red
pictured with pole 225WG



EP1
6"L x 3¹/₄"W, 2¹/₂" base
330 Bronze with Black
pictured with pole 2WG
coordinates with rosette REP1



WW203
5"L x 3¹/₄"W, 2³/₈" base
790 Vintage Bronze
pictured with pole 225WR



Y2K
7³/₈"L x 4"W, 2¹/₂" base
760 Rustic Iron
pictured with pole 225WR



WW21
7¹/₄"L x 4¹/₄"W, 2³/₄" base
107 Bronze with Gold and Gray
pictured with pole 225WR

ES item is available in Essential Sets, pages 74-75

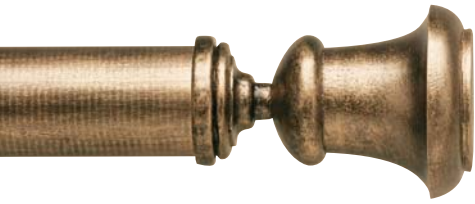

WW23
5"L x 2³/₄"W, 2¹/₄" base
155 Antique
pictured with pole VVWR



GB3
6"L x 4"W, 2³/₄" base
320 Pewter
pictured with pole 225WS



WW110
6¹/₄"L x 4"W, 2¹/₂" base
150 Gray with Gold
pictured with pole 225TR

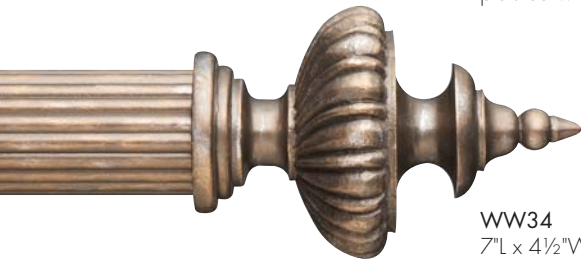

WW34
7"L x 4¹/₂"W, 2³/₄" base
690 Champagne
pictured with pole 225WR



EP7
7⁷/₈"L x 3³/₄"W, 2¹/₂" base
630 Ash Gray
pictured with pole 225WR



EP8
5⁵/₈"L x 3⁵/₈"W, 2³/₄" base
610 Cobalt Bronze
pictured with pole 225WR



225MC10
2¹/₂"L x 2⁷/₈"W, 2¹/₂" base
640 Oil Rubbed Bronze
pictured with pole 225WS



RF64
2⁵/₈"L x 2³/₈"W, 2¹/₂" base
770 Bronze Patina
pictured with pole VVWF
coordinates with rosette R64



RF22
4³/₄"L x 3¹/₂"W, 2¹/₂" base
107 Bronze with Gold and Gray
pictured with pole 2WR



WW251
3³/₄"L x 2³/₄"W, 2³/₈" base
760 Rustic Iron
pictured with pole 2WG



225MC5 **ES**
3"L x 3"W, 2¹/₂" base
105 Bronze
pictured with pole 225WS



WW9
3"L x 3³/₈"W, 2⁷/₈" base
790 Vintage Bronze
pictured with pole 225WS

2-2¹/₄"
wood and resin



RD225
6"L x 5¹/₂"W, 3¹/₄" base
155 Antique
pictured with pole 225TR



RF20
7¹/₄"L x 5"W, 2¹/₂" base
710 Tarnished Silver
pictured with pole 225WG

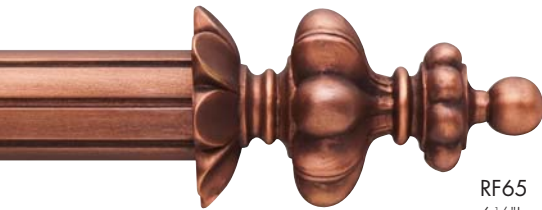

RF65
6¹/₄"L x 3⁷/₈"W, 2³/₈" base
730 Rose Gold
pictured with pole WWF



WW2
8¹/₄"L x 4¹/₈"W, 2³/₈" base
117 Walnut Gold
pictured with pole 225FL



WW206
5"L x 2³/₄"W, 2¹/₄" base
770 Bronze Patina
pictured with pole 225WG



RF21
9¹/₂"L x 9³/₄"W, 2³/₄" base
610 Cobalt Bronze
pictured with pole 225VWR

custom finishing

Dreaming of drapery hardware in the exact shade of lavender in your wallpaper? Let us help you.



Customization has been our custom since we began...

Beyond our standard finishes, we can match any finish on request. Just provide us with a finish sample or a paint color, manufacturer, and sheen level.

We will then provide you with a strike-off sample on your choice of any wood or steel pole profile. Your approval of the strike-off sample is required before production will begin.

wood finials



225EC
1¹/₈"L x 2³/₄"W
720 Tawny Oak
pictured with pole 225WS



2EC **ES**
1¹/₈"L x 3"W
650 Hickory
pictured with pole WWR
fits 2" Dia pole only



WW79
6³/₈"L x 3¹/₂"W, 2¹/₂" base
660 Antique White
pictured with pole WWR



W2400
6"L x 3¹/₂"W, 2³/₈" base
240 Walnut
pictured with pole 225WS



WD60
2³/₄"L x 3¹/₂"W, 3¹/₂" base
740 Smoky Macha
pictured with pole 225WG



WW90
6"L x 3¹/₂"W, 2³/₄" base
720 Tawny Oak
pictured with pole 225FL

wood finials



W551
5¹/₂"L x 3¹/₂"W, 2¹/₄" base
240 Walnut
pictured with pole 225WG

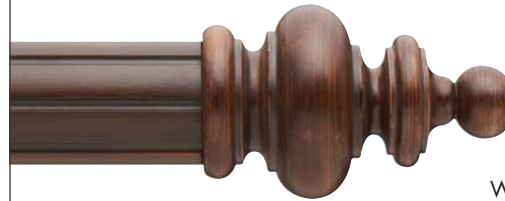

WW91
5³/₄"L x 3¹/₂"W, 2³/₄" base
650 Hickory
pictured with pole 225FL



WF10
6¹/₂"L x 3¹/₄"W, 2³/₈" base
780 Hazelwood
pictured with pole 225WWR



WY10
7"L x 3³/₄"W, 2¹/₂" base
670 Espresso
pictured with pole 225WG



WW77 **ES**
4⁵/₈"L x 3"W, 3" base
670 Espresso
pictured with pole 225WS



225WF90
4³/₄"L x 3¹/₄"W, 2³/₄" base
240 Walnut
pictured with pole 225WR

brackets

standard



WWB1
wood bracket, single
4³/₈" backplate, 3¹/₂" return

WWB2
wood bracket, single
4¹/₂" backplate, 6" return

225WB1
wood bracket, single
4³/₈" backplate, 3¹/₂" return

225WB2
wood bracket, single
4³/₈" backplate, 6" return



EB2254
wood bracket, single
2¹/₄" backplate, 4" return

EB2256
wood bracket, single
2¹/₄" backplate, 7" return

EB24
wood bracket, single
2³/₈" backplate, 4" return

EB26
wood bracket, single
2³/₈" backplate, 6" return



CSB1
wood bracket, single
3¹/₂" backplate, 3¹/₂" return

CSB2
wood bracket, single
2⁷/₈" backplate, 6" return

225WCS1
wood bracket, single
2⁷/₈" backplate, 3¹/₂" return

225WCS2
wood bracket, single
2³/₄" backplate, 6" return



ISM
inside wood mount bracket
for poles 2", 2¹/₄" Dia
3¹/₂" backplate, 1" deep, 4¹/₈" W



BKT200-214 NEW
adjustable steel
bracket, single
3¹/₂" backplate,
3³/₄"-5" return



WL1
steel bracket, single
2¹/₂" backplate, 3¹/₂" return

WL2
steel bracket, single
2¹/₂" backplate, 6" return



EB7
steel eyelet bracket, single
3¹/₂" backplate, 3¹/₂" return,
eyelet 2³/₈" ID

EB8
steel eyelet bracket, single
3¹/₂" backplate, 6" return,
eyelet 2³/₈" ID



WL3
steel bracket, single
3¹/₂" backplate, 10" return

WL4
steel bracket, single
4¹/₄" backplate, 3¹/₂" return

WL5
steel bracket, single
4¹/₄" backplate, 6" return



CSWB1
steel bracket, single
3¹/₂" W x 1¹/₂" H backplate,
3¹/₂" return

CSWB2
steel bracket, single
3¹/₂" W x 1¹/₂" H backplate,
6" return

Return distance is from wall to center of cradle. All standard steel brackets are shown in 680 Aged Gold.

custom

The Finial Company is known for flexibility, especially in custom metal work. For more custom product options, see our **Custom Solutions** section beginning on page 5.



TBKT
custom steel t-bracket
please specify:
A. return (distance from
wall to center of cradle)
B. pole size and profile
note: 3¹/₂" H backplate
comes standard, unless
otherwise specified



DBL1
custom steel double bracket
please specify:
A. front pole size and profile
B. back pole size and profile
C. rings to be used, if any
D. front and back returns
(distance from wall to
center of cradle)
note: returns are contingent
upon which poles and rings
are chosen
3¹/₂" H backplate comes
standard, unless otherwise
specified



BL4
custom steel ceiling mount
bracket
please specify:
A. drop (distance from
ceiling to top of pole)
B. pole size and profile
C. rings to be used, if any
note: minimum drop is
contingent upon which finial
and ring are chosen.
2¹/₂" W backplate comes
standard, unless otherwise
specified



FBKT
custom steel single bracket
please specify:
A. return (distance from wall
to center of cradle)
B. pole size and profile
note: 4³/₄" H backplate may
not be modified

Return or drop distance in excess of 8" on any custom bracket will incur additional fees and requires addition of support arm. Custom brackets are shown unfinished.



LFB3
resin bracket, single
4⁵/₁₆" backplate, 3¹/₂" return



DB76
resin bracket, single
8⁵/₁₆" backplate, 3³/₄" return



DB78
resin bracket, single
8⁵/₁₆" backplate, 3³/₄" return



DB91
resin bracket, single
8⁵/₁₆" backplate, 3¹/₂" return



DB80
resin bracket, single
3¹/₂" backplate, 3¹/₂" return

LFB4
resin bracket, single
4⁵/₁₆" backplate, 6" return

DB92
resin bracket, single
8⁵/₁₆" backplate, 6" return

Return distance is from wall to center of cradle. All standard resin brackets are shown in 107 Bronze with Gold and Gray



Looking for a wood or resin rosette to complete your look?
Turn to page 64 to see all rosette and tieback choices.

wood pole connections and splices

Here are three ways we connect wood poles and fascia.
Which way works for you?



pole connector screw
(for poles)

Join two poles with a connector screw. Ask for one with your order.

Positioning a support bracket at this connection is important. It helps conceal the splice while offering additional support to this fragile area.



standard 45° splice
(for poles and fascia)

We cut every fascia splice with a 45° angle. This breaks up the visual line of the connection, obscuring the splice better than a straight cut.

Pole or fascia will be spliced at center of total length.

Wood glue is not included and must be supplied by the installer.



blended splice
(for poles and fascia)

For an additional fee per splice we can properly connect your splice(s) and ship your wood pole or fascia in one continuous length.

We call it "blended" because we also fill in and paint the connection for a seamless look.

rings



WWRG for 2" pole
fluted wood ring
2³/₈"ID, 2⁷/₈"OD

225RWR for 2¹/₄" pole
fluted wood ring
2³/₄"ID, 4³/₈"OD



SR7 for 2" pole
smooth steel ring
2¹/₄"ID, 2³/₄"OD

SR12 for 2¹/₄" pole
smooth steel ring
2¹/₂"ID, 3"OD



OVL7 for 2" pole
oval smooth steel ring
2¹/₄"ID, 2³/₄"OD

OVL12 for 2¹/₄" pole
oval smooth steel ring
2¹/₂"ID, 3"OD



OVL2
oval hammered steel ring
2¹/₂"ID, 3¹/₂"OD



DRRG3
leafy resin ring
3"ID, 4¹/₂"OD



SR5
twisted steel ring
2¹/₂"ID, 3"OD



HSR2
hammered steel ring
2¹/₂"ID, 3"OD

poles



WWR 2" smooth wood
225WS 2¹/₄" smooth wood

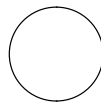

2WR 2" reeded wood
225WR 2¹/₄" reeded wood



2WG 2" grooved wood
225WG 2¹/₄" grooved wood

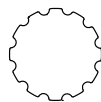

225WWR 2¹/₄" wide reeded wood

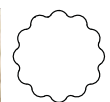

WWF 2" fluted wood
225FL 2¹/₄" fluted wood

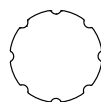

2TR 2" twisted wood
225TR 2¹/₄" twisted wood

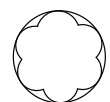

2" and 2¹/₄" wood poles are sold in 2 foot increments, 2 foot minimum. Poles will be cut to specified length. Fall off will not be saved or shipped. Maximum length of all 2" and 2¹/₄" wood poles is 192".

accessories



MB214
metal band, attaches any rosette to front of 2¹/₄" diameter pole
use with 2¹/₄" pole only
for more information on metal bands, see page 69



MB214 band, R2 rosette, 225WG pole, finish 710 Tarnished Silver



LELB
flexible wood elbow for connecting 2" or 2¹/₄" wood poles
4"L (3¹/₄"L when bent), 2¹/₄" base



- A WBTN**
wood baton, paint or stain
3/8"Dia
specify length up to 48"
- B SBTN**
steel baton, paint only
3/8"Dia
specify length up to 96"
- C FBTN**
fiberglass baton, white
3/8"Dia
specify length up to 48"
- D EPBTN1**
wood baton, paint or stain
3/8"Dia, handle: 6 1/8"L x 1 1/4"Dia
specify length up to 48"
- E EPBTN2**
wood baton, paint or stain
3/8"Dia, handle: 5 3/4"L x 1 1/2"Dia
specify length up to 48"

Our Wood and Resin Products look great in every finish, but here are a few that our expert hand finishing team recommends specifically for wood and resin products:



107 Bronze with Gold and Gray



155 Antique

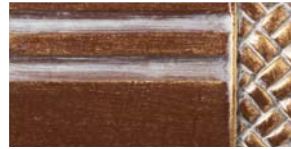

200 Walnut Gold with Gray Accents



270 Mahogany Rust

Wishing for the convenience and cost-savings of a complete Wood and Resin drapery hardware set? Check out 2" Essential Sets on page 75 in our Special Collections.



GB1SET in 110 Flat Black with Gold

Can't find our sleek Modern Collection? See pages 76-77 in Special Collections.



SG120-1 finial in Brushed Nickel, ML100-GM pole, SG500 rings in Brushed Nickel

3"

wood and resin



EC300-1 **NEW**
1½"L x 3¾"W, 3¾" base
670 Espresso
pictured with pole 3SM



F300-1 **NEW**
6¼"L x 4¾"W, 3½" base
650 Hickory
pictured with pole 3GR

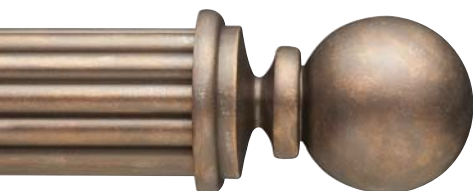

F300-2 **NEW**
5½"L x 3¾"W, 3¾" base
690 Champagne
pictured with pole 3RD

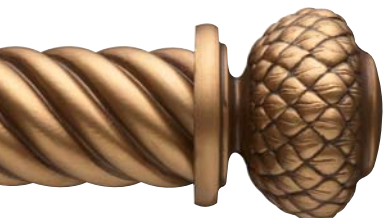

F300-3 **NEW**
3⅞"L x 4½"W, 3⅞" base
680 Aged Gold
pictured with pole 3TR
coordinates with rosette ROS5



F300-4C **NEW**
4⅞"L x 4¼"W, 3⅝" base
640 Oil Rubbed Bronze
pictured with pole 3SM
coordinates with rosette ROS1C



F300-4S **NEW**
4⅞"L x 4¼"W, 3⅝" base
106 Bronze with Gold
pictured with pole 3SM
coordinates with rosette ROS1S



WW26
5½"L x 3¾"W, 3¾" base
117 Walnut Gold
pictured with pole 3RD

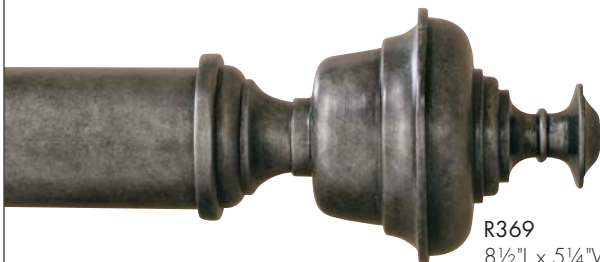

R369
8½"L x 5¼"W, 3½" base
320 Pewter
pictured with pole 3SM



3RF10
7¼"L x 4"W, 3¼" base
760 Rustic Iron
pictured with pole 3RD



3RF86
7"L x 5¼"W, 3¾" base
270 Mahogany Rust
pictured with pole 3RD



3R9
4"L x 4"D, 3⅝" base
750 Polished Gold
pictured with pole 3SM



WW75
7½"L x 4⅞"D, 3⅝" base
600 Gilded Red
pictured with pole 3SM



3RY10
8¼"L x 4½"W, 4" base
610 Cobalt Bronze
pictured with pole 3GR



3W100
8"L x 4½"W, 3½" base
107 Bronze with
Gold and Gray
pictured with pole 3GR



3W200
7½"L x 4"W, 3½" base
620 Weathered Iron
pictured with pole 3GR



F513
7"L x 4"W, 3¼" base
660 Antique White
pictured with pole 3GR



3RF20
11¼"L x 7¼"W, 3⅝" base
155 Antique
pictured with pole 3GR



RD3
7¾"L x 7"W, 4" base
790 Vintage Bronze
pictured with pole 3RD



3R35
8½"L x 6½"W, 3¾" base
155 Antique
pictured with pole 3RD



3MC11
3"L x 5½"W, 3½" base
700 Graphite
pictured with pole 3SM
coordinates with rosette RMC11

3"

wood and resin

wood finials



3EC
1 1/8" L x 3 3/4" W
670 Espresso
pictured with pole 3SM



3WF10
8" L x 4 3/8" W, 3 3/8" base
740 Smoky Mocha
pictured with pole 3RD

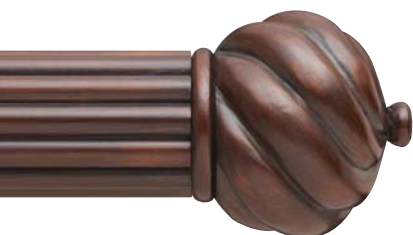

3W9
4 1/4" L x 4 1/4" W, 3 1/8" base
650 Hickory
pictured with pole 3RD



3W75
8" L x 4 1/2" W, 3 1/8" base
780 Hazelwood
pictured with pole 3SM



3WY10
8 1/4" L x 4 1/2" W, 3 3/8" base
720 Tawny Oak
pictured with pole 3GR

wood finials



3W513
6 1/2" L x 4 1/4" W, 3 1/8" base
670 Espresso
pictured with 3GR



3148
6 1/2" L x 4" W, 3 1/4" base
660 Antique White
pictured with pole 3SM

custom wood stains

Wishing your drapery hardware could have the same wood tone as the dining room table? Let us help you.



A wood stain may be specified for any of our wood products. Just provide us with a finish sample or a stain color, manufacturer, and sheen level.

We will then provide you with a strike-off sample on your choice of any wood pole profile. Your approval of the strike-off sample is required before production will begin.

Because our wood products are made from a variety of wood species, staining evenly from piece to piece can sometimes be tricky. Our expert finishing team can also replicate wood tones with paint. No matter how it's achieved, we can create your ultimate wood tone.

rings



WRG3
ribbed wood ring
3 3/8"ID, 5 1/8"OD



DRRG4
leafy resin ring
3 3/8"ID, 5 1/4"OD



SR11
smooth steel ring
3 1/2"ID, 4"OD



HSR3
hammered steel ring
3 1/2"ID, 4 1/4"OD

poles

3"
wood and resin



3SM 3" smooth wood

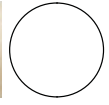

3GR 3" grooved wood

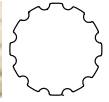

3RD 3" reeded wood

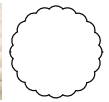

3TR 3" twisted wood

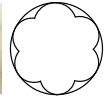

3" wood poles are sold in 2 foot increments, 2 foot minimum. Poles will be cut to specified length. Fall off will not be saved or shipped. Maximum length of all 3" wood poles is 192".

accessories



3LELB
flexible wood elbow for connecting 3" wood poles
4 7/8"L (3 3/4"L when bent), 2 7/8" base



A B C D E

- A WBTN**
wood baton, paint or stain
5/8"Dia
specify length up to 48"
- B SBTN**
steel baton, paint only
5/8"Dia
specify length up to 96"
- C FBTN**
fiberglass baton, white
5/8"Dia
specify length up to 48"
- D EPBTN1**
wood baton, paint or stain
5/8"Dia, handle: 6 1/8"L x 1 1/4"Dia
specify length up to 48"
- E EPBTN2**
wood baton, paint or stain
5/8"Dia, handle: 5 3/4"L x 1 1/2"Dia
specify length up to 48"

brackets

standard



3WB1
wood bracket, single
4¾" backplate, 4½" return

3WB2
wood bracket, single
4⅞" backplate, 5¼" return



3EB4
wood bracket, single
3½" backplate, 4½" return



3CSB1
wood bracket, single
3⅝" backplate, 4½" return

3CSB2
wood bracket, single
3⅝" backplate, 5¼" return



3L1
steel bracket, single
2½" backplate, 3½" return

3L2
steel bracket, single
2½" backplate, 4½" return

3L3
steel bracket, single
2½" backplate, 6" return



3L6
steel bracket, single
4¾" backplate, 6" return

3L5
steel bracket, single
3½" backplate, 3½" return

3L4
steel bracket, single
3½" backplate, 10¼" return

Return distance is from wall to center of cradle. All standard steel brackets are shown in 680 Aged Gold.

custom

The Finial Company is known for flexibility, especially in custom metal work. For more custom product options, see our **Custom Solutions** section beginning on page 5.



TBKT
custom steel t-bracket
please specify:
A. return (distance from wall to center of cradle)
B. pole size and profile
note: 3½"H backplate comes standard, unless otherwise specified



DBL1
custom steel double bracket
please specify:
A. front pole size and profile
B. back pole size and profile
C. rings to be used, if any
D. front and back returns (distance from wall to center of cradle)
note: returns are contingent upon which poles and rings are chosen
3½"H backplate comes standard, unless otherwise specified



BL4
custom steel ceiling mount bracket
please specify:
A. drop (distance from ceiling to top of pole)
B. pole size and profile
C. rings to be used, if any
note: minimum drop is contingent upon which finial and ring are chosen.
2½"W backplate comes standard, unless otherwise specified



FBKT
custom steel single bracket
please specify:
A. return (distance from wall to center of cradle)
B. pole size and profile
note: 4¾"H backplate may not be modified

Return or drop distance in excess of 8" on any custom bracket will incur additional fees and requires addition of support arm. Custom brackets are shown unfinished.



3LFB1
resin bracket, single
4 $\frac{7}{8}$ " backplate, 4 $\frac{1}{2}$ " return

3LFB2
resin bracket, single
5 $\frac{1}{4}$ " backplate, 5 $\frac{3}{4}$ " return



DB77
resin bracket, single
9 $\frac{3}{8}$ " backplate, 3 $\frac{3}{4}$ " return



DB79
resin bracket, single
3 $\frac{3}{4}$ " backplate, 4 $\frac{1}{4}$ " return



3FRB
resin bracket, single
12 $\frac{7}{8}$ " backplate, 4 $\frac{1}{2}$ " return



DB93
resin bracket, single
8 $\frac{3}{8}$ " backplate, 4 $\frac{1}{2}$ " return

DB94
resin bracket, single
8 $\frac{3}{8}$ " backplate, 6" return

Return distance is from wall to center of cradle. All standard resin brackets are shown in 107 Bronze with Gold and Gray

wood pole connections and splices

Here are three ways we connect wood poles and fascia.

Which way works for you?



pole connector screw (for poles)

Join two poles with a connector screw. Ask for one with your order.

Positioning a support bracket at this connection is important. It helps conceal the splice while offering additional support to this fragile area.



standard 45° splice (for poles and fascia)

We cut every fascia splice with a 45° angle. This breaks up the visual line of the connection, obscuring the splice better than a straight cut.

Pole or fascia will be spliced at center of total length.

Wood glue is not included and must be supplied by the installer.



blended splice (for poles and fascia)

For an additional fee per splice we can properly connect your splice(s) and ship your wood pole or fascia in one continuous length.

We call it "blended" because we also fill in and paint the connection for a seamless look.

rosettes

metal and resin



RRND
1 1/4"Dia, steel
109 Flat Black



SEC125
1 1/4"Dia, steel
750 Polished Gold



EC4
1 1/4"Dia, steel
690 Champagne



EC2
1 3/8"Dia, brass
730 Rose Gold



R56
2 1/8"Dia, resin
710 Tarnished Silver



RDSY2
2 1/2"Dia, brass
660 Antique White



REC73
2 3/4"Dia, resin
107 Bronze with Gold & Gray



RF63R
2 7/8"Dia, resin
320 Pewter
coordinates with finial RF63



R16 OH
3"Dia, steel
110 Flat Black with Gold



R105
3 1/2"Dia, steel
100 Polished Steel*



R23
3 1/2"Dia, steel
250 Platinum



R18
3 1/2"Dia, resin
760 Rustic Iron



ROS1C NEW
3 3/4"Dia, resin
670 Espresso
*coordinates with finial
F214-15C and F300-4C*



ROS1S NEW
3 3/4"Dia, resin
640 Oil Rubbed Bronze
*coordinates with finials
F214-15S and F300-4S*



R22
3 3/4"Dia, steel
700 Graphite



R15
3 3/4"Dia, resin
720 Tawny Oak

*Please note: there is an upcharge for this custom finish; please refer to price list for details.

OH item is available in Outdoor Hardware, pages 78-80

rosettes

metal and resin



EC1
1½"Dia, brass
630 Ash Gray



RF4
1⅞"Dia, resin
680 Aged Gold



EC3
2"Dia, brass
710 Tarnished Silver



SEC2
2"Dia, steel
790 Vintage Bronze



R21
2⅞"Dia, steel
107 Bronze with
Gold and Gray



R24
3"Dia, resin
200 Walnut Gold
with Gray Accents



R65
3"Dia, resin
112 Silver with Gold



R64
3"Dia, resin
106 Bronze with Gold
coordinates with finial RF64



R67
3½"Dia x 2¾" deep, resin
600 Gilded Red



R102 **OH**
3⅝"Dia, steel
330 Bronze with Black



RMC13
3⅝"Dia, resin
740 Smoky Mocha
coordinates with finial 225MC13



R57
3¾"Dia, resin
155 Antique



RMC1
3⅞"Dia, resin
106 Bronze with Gold



ROS2 **NEW**
4"Dia, resin
610 Cobalt Bronze
coordinates with finial F138-6



R11
4"Dia, resin
770 Bronze Patina



RMC14
4"Dia, resin
330 Bronze with Black

rosettes

metal and resin



REP1
4½"Dia, resin
760 Rustic Iron
coordinates with finial EP1



R5
4¼"Dia, resin
155 Antique



ROS6C **NEW**
3"Sq, 4¼"Dia, resin
760 Rustic Iron
coordinates with finials
F138-4C and F214-16C



ROS6S **NEW**
3"Sq, 4¼"Dia, resin
720 Tawny Oak
coordinates with finials
F138-4S F214-16S



R2
4½"Dia, resin
630 Ash Gray



R73
4½"Dia, resin
610 Cobalt Bronze



R17
4¾"Dia, steel
690 Champagne



R1
4"H x 5¼"W, resin
106 Bronze with Gold



R101 **OH**
5½"Dia, brass
270 Mahogany Rust
with custom gold*



ROS4 **NEW**
5¾"Dia, resin
740 Smoky Mocha

*Please note: there is an upcharge for this custom finish; please refer to price list for details.

OH item is available in Outdoor Hardware, pages 78-80

rosettes

metal and resin



R104
4¼"Dia, steel
250 Platinum



RMC11
4¼"Dia, resin
107 Bronze with Gold and Gray
coordinates with finial 225MC11



RDSY4 **OH**
4¾"Dia, brass
750 Polished Gold



R103
4½"Dia, steel
155 Antique



ROS3 **NEW**
5"Dia, resin
620 Weathered Iron
coordinates with finials F214-2 and F214-3



R8
5"Dia, resin
710 Tarnished Silver
coordinates with finial WW70



R107
5¼"Dia, steel
790 Vintage Bronze



ROS5 **NEW**
6"Dia, resin
730 Rose Gold
coordinates with finials F2145 and F300-3



R10
4¾"Sq, 7"Dia, resin
117 Walnut Gold

rosettes

wood



WD60
 3½"Dia x 2¾" deep, wood
 670 Espresso
coordinates with finial WD60 and WW60



WR40
 4"Dia, wood
 650 Hickory



WR30
 4¼"Dia, wood
 720 Tawny Oak



WR2
 4½"Dia, wood
 740 Smoky Mocha



WR50
 6⅞"W x 4½"H, wood
 780 Hazelwood

accessories



steel tieback post for rosettes
 backplate 1¾"Dia
 NBL2 2½" projection
 NBL4 3½" projection
 NBL6 6" projection



wood tieback post for rosettes
 base 1⅝"Dia
 WTBS2 2½" projection
 WTBS4 4¼" projection
 WTBS6 6" projection



steel brackets for rosettes
 backplate 2¼"H x ½"W
 BL2 2½" projection
 BL3 3½" projection
 BL6 6" projection

metal bands

attach any rosette to the front of a pole

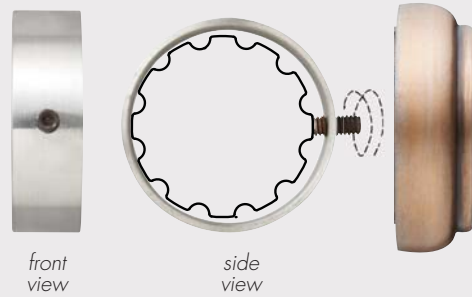

Metal band slides onto pole and is locked in place with set screw. Set screw should be positioned in the front center of pole because it receives the rosette.



MB100
1" Dia metal band attaches any rosette to front of a 1" Dia pole
rosettes sold separately
shown: EC3 rosette on RR100 pole, finish 620 Weathered Iron



MB138
1 3/8" Dia metal band attaches any rosette to front of a 1 3/8" Dia pole
rosettes sold separately
shown: R24 rosette on WS38 pole, finish 200 Walnut Gold with Gray Accents



MB214
2 1/4" Dia metal band attaches any rosette to front of a 2 1/4" Dia pole
rosettes sold separately
shown: R2 rosette on 225WG pole, finish 710 Tarnished Silver

common uses for metal bands

1. repeated decorative embellishment along the length of a pole

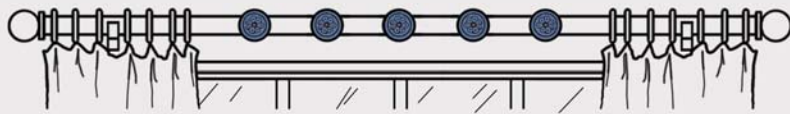

2. hold gathered rod pocket fabric panel in place

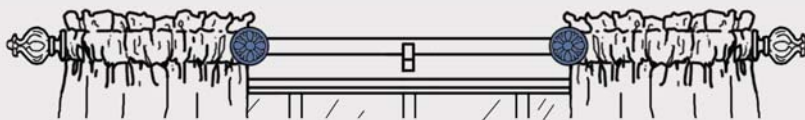

3. ring stop

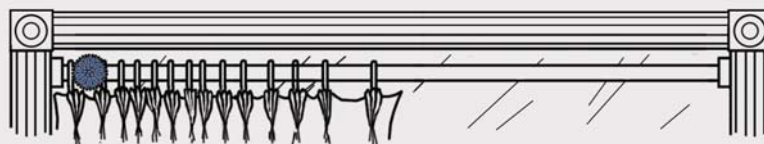

tiebacks



STBA21
9"L x 5" projection
Please specify right (as shown) or left
100 Polished Steel*

**please note: there is an upcharge for this custom finish; please refer to price list for details.*



STBA7
9½"L x 5" projection
730 Rose Gold



STBA8 OH
9"L x 4½" projection
please specify right (as shown) or left
100 Polished Steel*

**please note: there is an upcharge for this custom finish; please refer to price list for details.*



STBA3
8"L x 5" projection
100 Polished Steel*

**please note: there is an upcharge for this custom finish; please refer to price list for details.*



STB
10"L x 4¾"W
640 Oil Rubbed Bronze



TTBH1 OH
4½"L x 1¼" projection
790 Vintage Bronze



TTBH2 OH
3½"L x 1¼" projection
270 Mahogany Rust



STBA5
tieback 11"L x 3¾"W
backplate 5½"H x 2½"W
620 Weathered Iron
sold individually



OH item is available in Outdoor Hardware, pages 78-80



RTB18
 8¼"L
 107 Bronze with Gold and Gray
 sold in pairs only
 wood tieback post included
 specify length of post: 2½", 4¼" or 6"



TB19
 12¾"L
 107 Bronze with Gold and Gray
 sold in pairs only
 wood tieback post included
 specify length of post: 2½", 4¼" or 6"

custom

The Finial Company is known for flexibility, especially in custom metal work. For more custom product options, see our **Custom Solutions** section beginning on page 5.



TBA
 6"L x 4½" projection
 100 Polished Steel*
 attach finial or rosette of choice to face or tip of TBA
 pictured with L651 finial
 finial sold separately



STBA1
 8"L x 6½" projection
 610 Cobalt Bronze
 attach finial or rosette of choice
 pictured with R73 rosette
 rosette sold separately

**please note: there is an upcharge for this custom finish; please refer to price list for details.*

crests

standard crests attach to pole with L-bracket or attach to wall with custom H-bracket



C1
20"W x 8¾"H
155 Antique
pictured with WW201 finials and 225TR pole



C2
23¾"W x 9"H
107 Bronze with Gold & Gray



C6
26¼"W x 7½"H
200 Walnut Gold with Gray



C7
16½"W x 7¼"H
710 Tarnished Silver



C8
27½"W x 15¼"H
155 Antique

Crests are versatile decorative tools that can be used in a variety of creative ways. Here are three ideas.

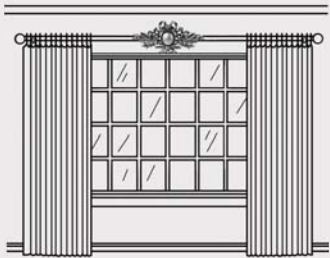

embellish the center of a pole while also obscuring the center support bracket

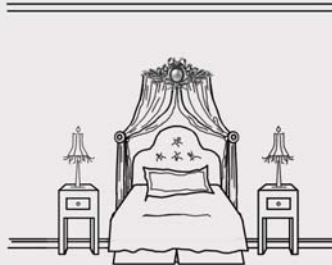

use as a pelmet over gathered fabric panels at the head of a bed

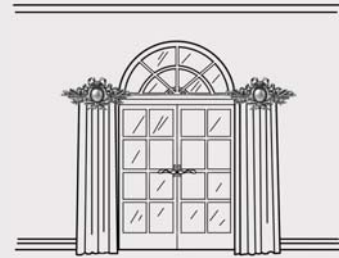

use as a pelmet over a stationary drapery panel

for installation information, please refer to the Retail Price List for details

pole mount crests slide onto pole



C4
10¾"W x 4¼"H
155 Antique
pictured with RD225 finials in 155 Antique and 225WR pole in 109 Flat Black
use with 2¼" pole only



C3
14¾"W x 6"H
155 Antique
pictured with RD3 finials in 155 Antique and 3RD pole in 109 Flat Black
use with 3" pole only

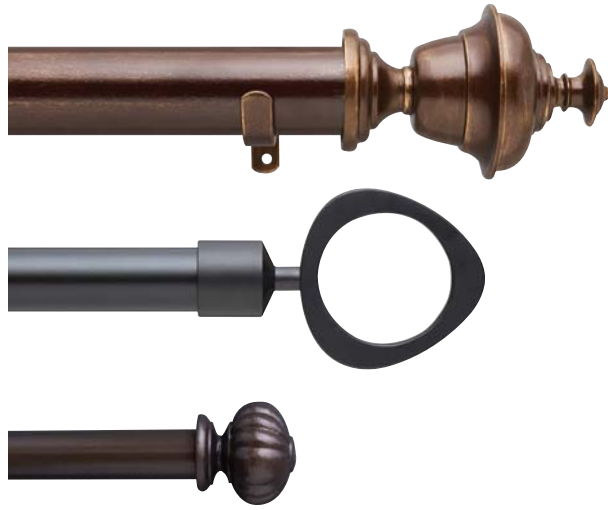

special collections

essential sets

1" diameter sets	74
2" diameter sets	75

the modern collection

1" diameter product	76
1 ³ / ₈ " diameter product	77

outdoor hardware collection

³ / ₄ " diameter product	79
1" diameter product	79
1 ¹ / ₄ " diameter product	79
1 ³ / ₄ " diameter product	79

³/₄"

1"

1¹/₄"

1³/₈"

1³/₄"

2"

1"

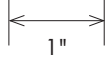
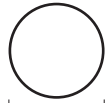

RR100

actual pole sizes

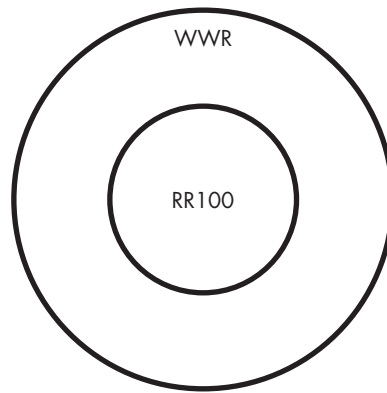

2"

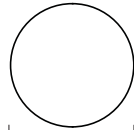

WWR

essential sets

1"

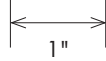
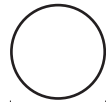

ML100-BN
ML100-B
ML100-GM
ML100-CH

ML138-BN
ML138-B
ML138-GM
AC138

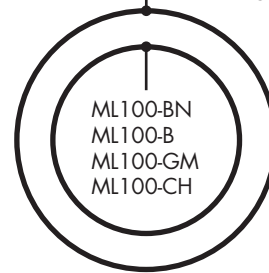

1 3/8"

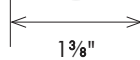
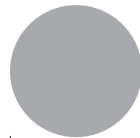

AC-138

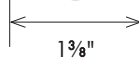
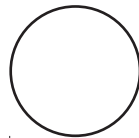

ML138-BN
ML138-B
ML138-GM

the modern collection

3/4"



75HSRB

1"

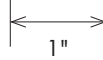
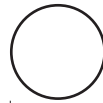

RR100

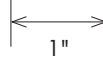

ST2

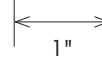

ST3

1 1/4"

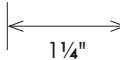
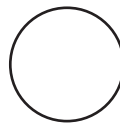

RR125

1 3/4"

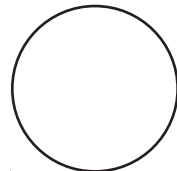

RR175

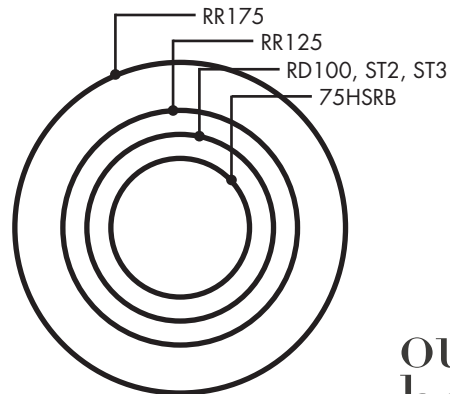

outdoor hardware collection



essential sets

We've done the work for you. We've selected 10 of our most popular, most essential finial designs and combined them with everything you need to complete your window treatment. Our easy-to-order Essential Sets come in 2 diameters – available in 5 hand painted finishes in 3 standard lengths – all at a 20% cost savings to you.



the modern collection

Comprised of sleek, smart designs in our 4 most contemporary finishes, The Modern Collection is our most unique product offering. Understated details and clean lines give this metal drapery hardware collection a fresh and sophisticated vibe.



outdoor hardware collection

Outdoor spaces need hardware, too. We've created 5 weather-resistant finishes and tested them for outdoor use on select products from our Steel Collection. Our 5 Year Warranty guarantees against rust and fading due to conditions such as UV exposure, humidity and sea spray. Let us help you design your outdoor spaces with confidence and style.

essential sets

Available in 3 lengths.
Can be cut to your
specification at no
additional charge.

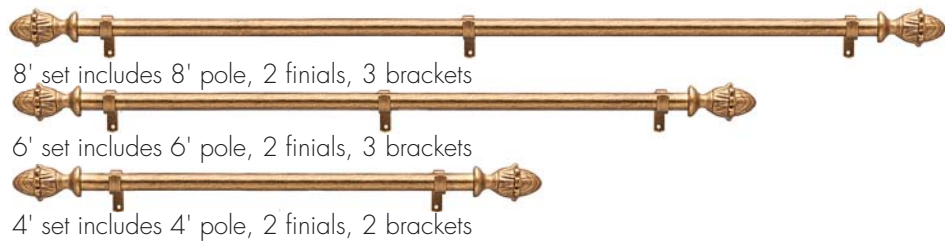

1" finial sets include 1" diameter steel pole and L135 steel brackets (3⁵/₈" return)



K657SET
finial: 4"L x 2"W, 1³/₄" base
set shown in 117 Walnut Gold



SF69SET
finial: 3¹/₂"L x 2¹/₂"W, 1³/₄" base
set shown in 110 Flat Black with Gold



SF133SET
finial: 2"L x 2³/₈"W, 1¹/₄" base
set shown in 105 Bronze



L9328BSET
finial: 2¹/₄"L x 2"W, 1³/₈" base
set shown in 126 Dark Walnut Gloss with Gold



SEC125 SET
finial: 1¹/₄"L x 1¹/₄"W, 1¹/₄" base
set shown in 250 Platinum

20% savings
when you
buy in sets



1" inside mount set includes 1" diameter steel pole and steel inside mount brackets



IM125SET
1" inside steel mount set – 4' length only
inside mount bracket: 1¹/₈"H x 3⁴/₄"Deep, 1³/₈"W
set shown in 110 Flat Black with Gold

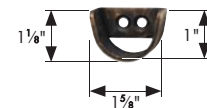

finishes all 1" and 2" sets available in 5 finishes

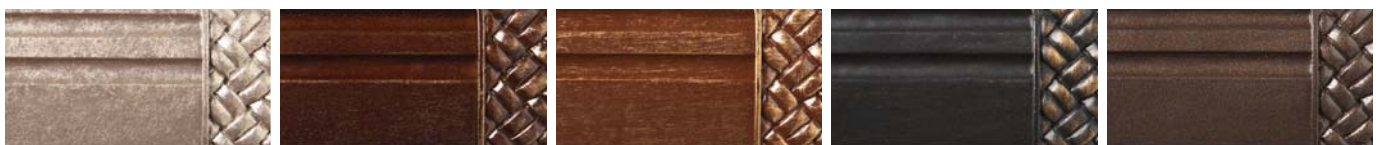

250 Platinum

126 Dark Walnut
Gloss with Gold

117 Walnut Gold

110 Flat Black with Gold

105 Bronze

5 finial sets in 2 diameters.
5 finishes. 5 day lead time.
20% SAVINGS

2" finial sets includes 2" diameter smooth wood pole and WL1 steel brackets (3 1/2" return)



R22569SET
finial: 6"L x 3 1/2"W, 2 1/2" base
set shown in 126 Dark Walnut Gloss with Gold



GB1SET
finial: 5"L x 3"W, 2 1/2" base
set shown in 110 Flat Black with Gold

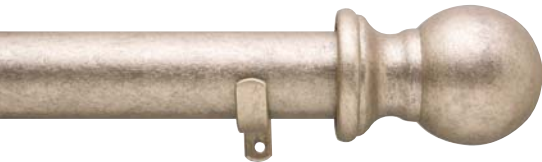

WW77SET
finial: 4 5/8"L x 3"W, 3" base
set shown in 250 Platinum



225MC5SET
finial: 3"L x 3"W, 2 1/2" base
set shown in 105 Bronze



2ECSET
finial: 1 1/8"L x 3"W, 2" base
set shown in 117 Walnut Gold

20% savings
when you
buy in sets

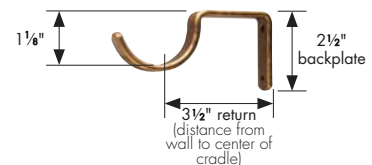

2" inside mount set includes 2" diameter wood pole and wood inside mount brackets



ISMSET
2" Inside Mount Set – 4' length only
inside mount wood bracket: 3 1/2"H x 4 1/8"W x 1"Deep
set shown in 250 Platinum

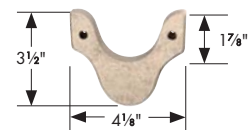

ring packs sold separately



1" rings
SR3SET
smooth steel ring, pack of 7
1 1/2"ID, 2"OD
shown in 117 Walnut Gold



2" rings
SR7SET
smooth steel ring, pack of 7
2 1/4"ID, 2 3/4"OD
shown in 110 Flat Black with Gold

artforms by design²



AF100-1
4¼"L x 2½"W, ⅞" pole inset
Available in Chrome only
pictured with pole ML100-CH



AF200-1
4⅝"L x 2¼"W, ¾" pole inset
Available in Chrome only
pictured with pole ML100-CH



AF300-1
3"L x 2¾"W, no pole inset
Available in Chrome only
pictured with pole ML100-CH

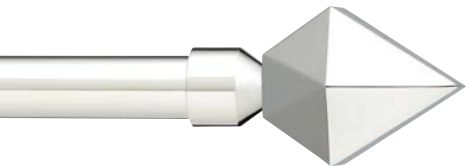

AF400-1
4¼"L x 2½"W, ¾" pole inset
Available in Chrome only
pictured with pole ML100-CH



AF500-1
5½"L x 2¾"W, ⅞" pole inset
Available in Chrome only
pictured with pole ML100-CH



AF600-1
4"L x 3"W, ¾" pole inset
Available in Chrome only
pictured with pole ML100-CH

finishes

Chrome is available in Artforms by design² product only

	
Brushed Nickel	Black
	
Gunmetal	Chrome



SG100-1
4¾"L x 2¾"W, ⅞" pole inset
Black
pictured with pole ML100-B



SG110-1
1"L x 2"W, ⅜" pole inset
Black
pictured with pole ML100-B



SG120-1
⅞"L (⅞"L) x 1"W, ¾" pole inset
Brushed Nickel
pictured with pole ML100-BN



SG130-1
1⅝"L x 1¾"W, ⅞" pole inset
Gunmetal
pictured with pole ML100-GM



SG140-1
2½"L x 2⅝"W, ⅞" pole inset
Brushed Nickel
pictured with pole ML100-BN



SG150-1
3¼"L x 2"W, ⅝" pole inset
Gunmetal
pictured with pole ML100-GM



SG160-1
3¾"L x 2⅝"W, ¾" pole inset
Black
pictured with pole ML100-B



SG170-1
3¾"L x 2¼"W, ¾" pole inset
Gunmetal
pictured with pole ML100-GM



SG180-1
2¾"L x 1⅝"W, 2⅝" pole inset
Brushed Nickel finial with
Chrome pole
ML100-CH

1 3/8"

the modern collection



SG140-1.375
2 3/8"L x 2 1/8"W, 7/8" pole inset
Gunmetal
pictured with pole ML138-GM



AC200
4 3/8"L x 2 1/4"W, 1" pole inset
Acrylic with Brushed Nickel only
pictured with pole ML138-BN



SG150-1.375
4"L x 2 1/2"W, 1" pole inset
Black
pictured with pole ML138-B



SG130-1.375
2"L x 1 3/4"W, 7/8" pole inset
Brushed Nickel
pictured with pole ML138-BN



SG120-1.375
1"L x 1 5/8"W, 7/8" pole inset
Brushed Nickel
pictured with clear acrylic pole AC138

please note: pole inset is length of pole covered by finial base

brackets

All brackets are available in Brushed Nickel (as shown), Black or Gunmetal. 1" brackets are also available in Chrome.

1" cradle brackets, 1 3/4"Dia backplate



SG360-1 single bracket
3 1/2" return



SG350-1 single bracket
6" return



SG370-1 double bracket
6 1/2" front return
3 1/4" back return

ceiling/center eyelet brackets, 1 3/4"Dia backplate



SG310-1 single bracket
3 1/2" return



SG300-1 single bracket
6" return



SG380-1 double bracket
7 1/4" front return
3 3/8" back return

please note: return distance is from wall to center of cradle

1 3/8" cradle brackets, 1 3/4"Dia backplate



SG360-1.375 single bracket
3 1/2" return



SG350-1.375 single bracket
6" return



SG370-1.375 double bracket
7 3/8" front return
3 3/8" back return

ceiling/center eyelet brackets, 1 3/4"Dia backplate



SG310-1.375 single bracket
3 1/2" return



SG300-1.375 single bracket
6" return



SG380-1.375 double bracket
7 7/8" front return
3 3/4" back return

poles

maximum pole lengths:
Brushed Nickel, 240 inches
Black and Gunmetal, 192 inches
Chrome and Clear Acrylic, 144 inches



Brushed Nickel



ML100-BN Brushed Nickel
ML100-B Black
ML100-GM Gunmetal
ML100-CH Chrome



Brushed Nickel



ML138-BN Brushed Nickel
ML138-B Black
ML138-GM Gunmetal
AC138 Clear Acrylic

inside mount brackets

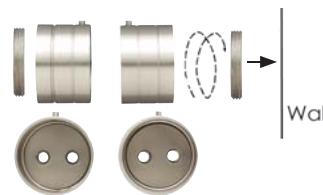

1" **SG400-1**
inside mount metal bracket set
for 1" poles

1 3/8" **SG400-1.375**
inside mount metal bracket set
for 1 3/8" poles

rings

available in Brushed Nickel (as shown), Black or Gunmetal.
SG500, SG510 and SG510I rings also available in Chrome.



smooth metal ring
SG500 1 1/4"ID (1" pole)
SG510 1 1/2"ID (1 1/8" pole)
SG520 2"ID (1 3/8" pole)



smooth metal ring
with plastic insert
SG510I 1 1/2"ID (1" pole)
SG520I 2"ID (1 3/8" pole)

accessories



SGSPLICE-1
splicer for 1" metal poles

SGSPLICE-1.375
splicer for 1 3/8" metal poles



SGLEB-1
elbow for 1" metal poles

SGLEB-1.375
elbow for 1 3/8" metal poles

please note: clear acrylic pole cannot be spliced

outdoor hardware

the outdoor hardware collection includes...

steel finials, poles, brackets, and rings

all products tested...

for outdoor use and guaranteed against:

- UV Exposure
- Humidity
- Sea Spray

5 year warranty

against rust and fading when
properly maintained

5 custom finishes

available on all Outdoor Hardware products
with protective high gloss, weather-resistant
topcoat

*Each order will include 2 oz. of finish and
protective topcoat for periodic maintenance.*



Outdoor Hardware Limited Warranty

All Outdoor Hardware is guaranteed to be free of manufacturing defects and is covered under our Manufacturers Limited Warranty. The product is guaranteed not to rust and the finish not to fade for 5 years if the product is maintained according to the "Product Care" information. In the event of rusting or fading, photography may be requested for finalization of claims on a case-by-case basis.

Outdoor Hardware Product Care

Unlike indoor drapery hardware, outdoor hardware requires periodic maintenance. It is important that any damages or finish abrasion be repaired immediately. Any scratches incurred during installation must be repaired at that time. Stainless steel mounting hardware is recommended, but not included. Each order will include 2 oz. of finish and protective topcoat for periodic maintenance.

In addition, twice a year, it is important to clean and inspect the outdoor hardware for scratches or wear patterns that could expose the metal and result in rusting. This is very important for treatments with rings. If such areas are discovered, apply the paint finish sent with the order. When dry, apply the clear protective topcoat also provided.

please note: allow 10-15 business days for production of Outdoor Hardware Collection. Professional installation recommended due to weight of steel products. Brackets recommended every 3 feet. Splicing not recommended for steel rods.

3/4" and 1"



1848
7 1/2"L x 4 1/4"W, 1" base
109-OH Flat Black
shown with pole 75HSRB



SEC125
1/4"L x 1 1/4"W, 1 1/4" base
450-OH Aluminium
shown with pole ST2

1" and 1 1/4"



EC135
1 1/4"L x 2 1/8"W, 2" base
109-OH Flat Black
shown with pole RR125



4519C
3 1/2"L x 2 1/2"W, 1 3/4" base
440-OH Soft Gold
shown with pole RR100



SF222
6 3/4"L x 3 3/4"W, 2" base
270-OH Mahogany Rust
shown with pole ST3



LS385
5"L x 4 1/2"W
450-OH Aluminium
shown with pole ST3

1 1/4" and 1 3/4"



SF63
2 1/2"L x 2 1/2"W, 2" base
105-OH Bronze
shown with pole RR125

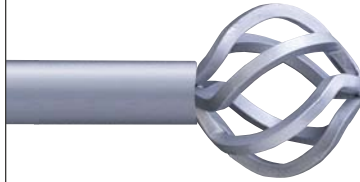

LS385
5"L x 4 1/2"W
450-OH Aluminium
shown with pole RR175

1 3/4"



SEC2
1/4"L x 2"W, 2" base
270-OH Mahogany Rust
shown with pole RR175



1848+FC1
8 3/4"L x 4 1/4"W, 2 3/8" base
109-OH Flat Black
pictured with pole RR175



SF151
3 1/2"L x 2 1/2"W, 2 1/8" base
109-OH Flat Black
shown with pole RR175

rosettes



R16
3"Dia
450-OH Aluminium



R102
3 3/8"Dia
105-OH Bronze



RDSY4
4 3/8"Dia
270-OH Mahogany Rust with
440-OH Soft Gold on petals *



R101
5 1/2"Dia
270-OH Mahogany Rust with
440-OH Soft Gold on petals *

* please note: there is a custom upcharge for this special finish treatment

rings



smooth steel ring
for 3/4" pole:
SR1 1"ID, 1 1/2"OD
for 1" or 1 1/4" pole:
SR3 1 1/2"ID, 2"OD
for 1 3/4" pole:
SR7 2 1/4"ID, 2 3/4"OD



hammered steel ring
for 1" or 1 1/4" pole:
HSR1 1 3/4"ID, 2 1/2"OD
for 1 3/4" pole:
HSR175 2"ID, 2 3/4"OD



twist steel ring
for 1", 1 1/4" or 1 3/4" pole:
SR5 2 1/2"ID, 3"OD



oval hammered steel ring
for 1" or 1 1/4" pole:
OVL1 1 3/4"ID, 2 1/2"OD
for 1 3/4" pole:
OVL175 2"ID, 2 3/4"OD

please note: rings may abrade protective outdoor finish with frequent use. Please see Product Care for maintenance recommendations.

poles



75HSRB 3/4"Dia hammered solid steel pole, round
maximum length is 120 inches



ST2 1" single twist solid steel pole
maximum length is 228 inches;
use ring with minimum 1 1/2"ID

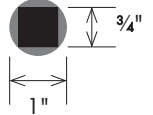

ST3 1" double twist solid pole
maximum length is 228 inches;
use ring with minimum 1 1/2"ID

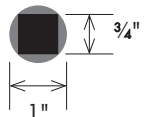

RR100 1"Dia round tube
RR125 1 1/4"Dia round tube
RR175 1 3/4"Dia round tube
maximum length is 192 inches



Steel poles are sold in 1 foot increments, 2 foot minimum. Poles will be cut to specified length. Fall off will not be saved or shipped.

brackets



steel bracket, single
L235 3 1/2" return, for 3/4", 1" and 1 1/4" pole
L26 6" return, for 3/4", 1" and 1 1/4" pole
B17535 3 1/2" return, for 1 3/4" pole
B1756 6" return, for 1 3/4" pole



steel eyelet bracket, single
EB3 3 1/2" return for 1" and 1 1/4" pole
EB4 6" return, for 1" and 1 1/4" pole
EB5 3 1/2" return, for 1 3/4" pole
EB6 6" return, for 1 3/4" pole



inside mount steel bracket
IM125 for 3/4", 1", 1 1/4" pole
1 1/8"H x 3/4"Deep, 1 5/8"W
IM175 for 1 3/4" pole
1 1/2"H x 3/4"Deep, 2 1/4"W

Return distance is from wall to center of cradle. All brackets are shown in 440-OH Soft Gold.

accessories



steel tieback post for rosettes
bottom base 1 3/4"Dia
NBL2 2 1/2" projection
NBL4 3 1/2" projection
NBL6 6" projection



standard tieback
TTBH2
3 1/2"L x 1 1/4" projection
109-OH Flat Black



standard tieback
TTBH1
4 1/2"L x 1 1/4" projection
450-OH Aluminum



leaf tieback
STBA21
9"L x 5" projection
109-OH Flat Black
please specify right (as shown) or left

finishes

please note: all Outdoor Hardware finishes have a high gloss protective topcoat



Aluminum
450-OH



Soft Gold
440-OH

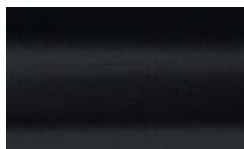

Flat Black
109-OH

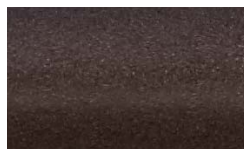

Bronze
105-OH



Mahogany Rust
270-OH



traverse systems

corded and motorized traverse 81

corded traverse fascia

cuts for standard and ball bearing systems

motorized traverse fascia

cuts for Somfy Glydea and BTX DC systems

2"

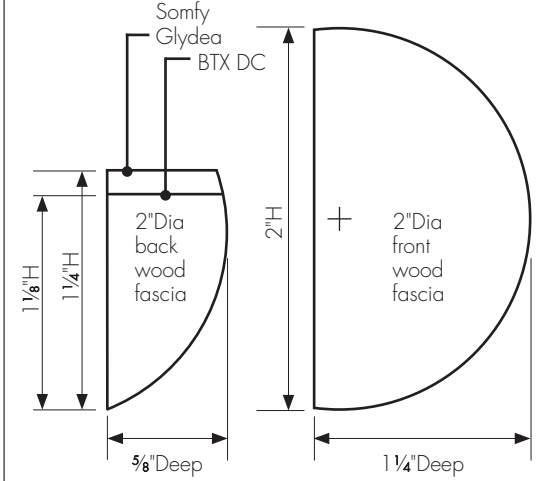
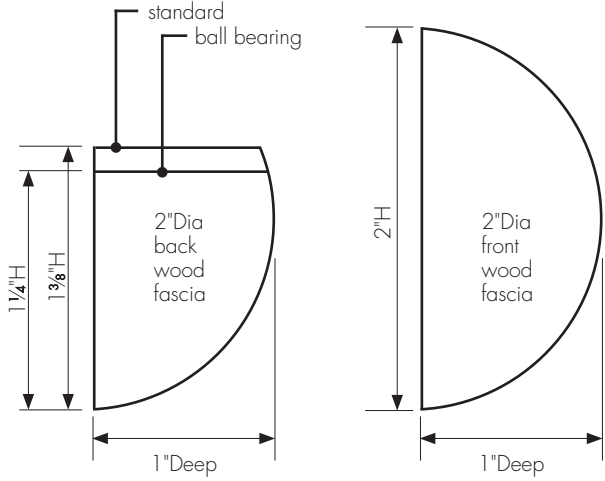

2 1/4"

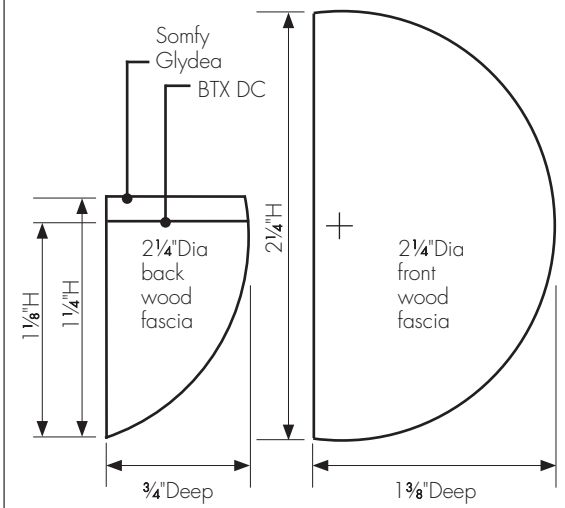
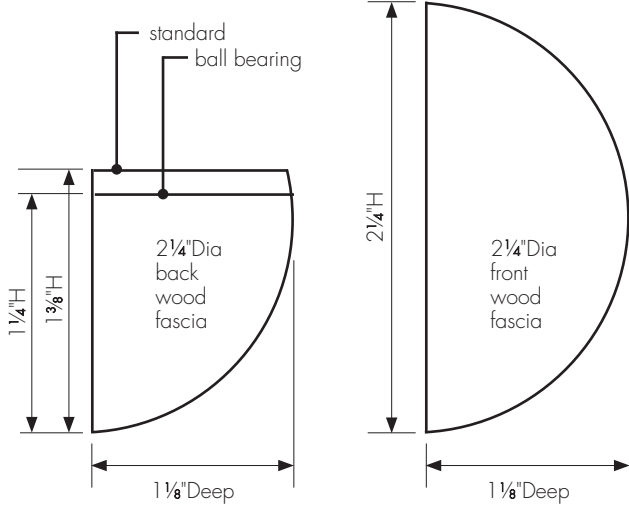

3"

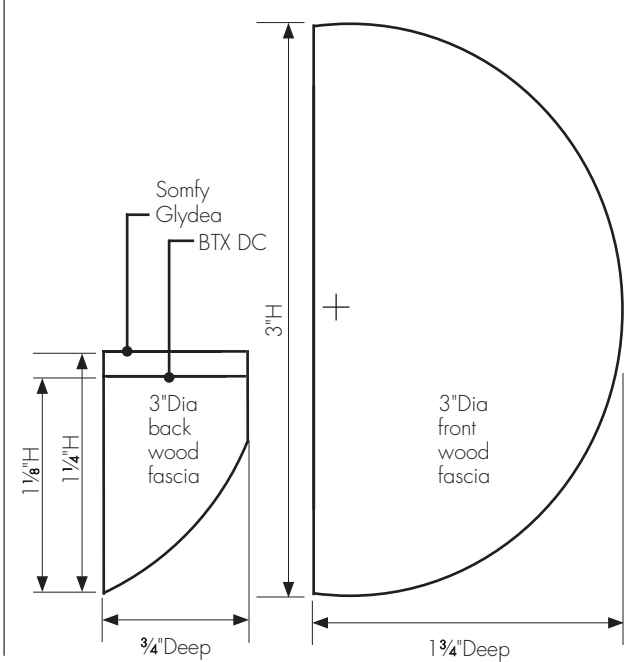
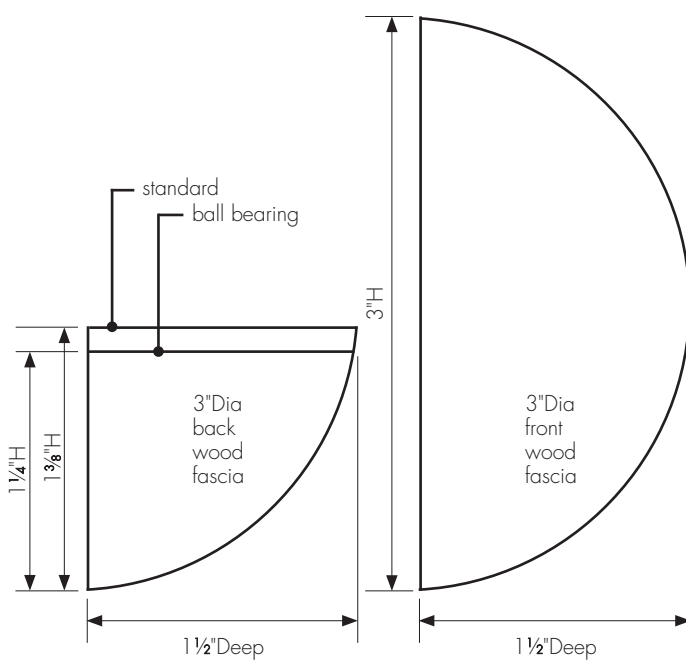



traverse systems

All the beautiful finials and poles in our 2", 2¼", and 3" Wood and Resin Collections can be paired with any of our Corded and Motorized Traverse Systems. Standard, heavy-duty and Ripplefold®-style options are available for every window treatment, from the light-weight sheers in the guest bedroom to the heavy black-out draperies in the media room.

corded traverse systems

STANDARD TRAVERSE SYSTEMS

- Recommended for lightweight fabrics & sheers
- Single & Double Track Systems available
- Center or One-Way Draw available
- Available with or without wood fascia
- All profiles for 2", 2¼" or 3" wood poles available
- Available with or without decorative wood C-rings
- Pinch pleat carriers available
- Track and brackets available in Bronze, Gold or White; glides available in Bronze or White
- Continuous track available up to 20', fascia available up to 16'; splices and blended splices can be used to achieve longer lengths

HEAVY DUTY BALL BEARING SYSTEMS

- Recommended for heavier treatments with lining or treatments mounted over 10' from floor
- Single & Double Track Systems available
- Center or One-Way Draw available
- Available with or without wood fascia
- All profiles for 2", 2¼" or 3" wood poles available
- Not available with C-rings
- Pinch pleat or Ripplefold®-style carriers available; 80%, 100% or 120% fullness
- Track and brackets available in Bronze, Gold or White; glides and end pulleys available in White only
- Continuous track available up to 20', fascia available up to 16'; splices and blended splices can be used to achieve longer lengths



SINGLE CORDED TRAVERSE SYSTEM WITH WOOD FASCIA

- standard single systems brackets are adjustable: 3½"-4½" projection
- 6" projection brackets may be substituted at no charge
- custom ceiling mount brackets may be substituted for an additional charge
- available with finials or 3½" and 6" mitered returns, sold separately
- C-rings available for traverse systems without mitered returns



DOUBLE CORDED TRAVERSE SYSTEM WITH WOOD FASCIA

- standard double system brackets are adjustable: 2½"-3½" back rod and 5½"-6¼" front rod projection
- custom ceiling mount brackets may be substituted for an additional charge
- available with finials or 6" mitered returns only, sold separately
- C-rings available on front track only for Standard Traverse Systems without mitered returns



DOUBLE CORDED SYSTEM WITH STATIONARY POLE ON FRONT AND TRAVERSE SYSTEM ON BACK

- to order: select Single Traverse System with or without Wood Fascia
- Single Traverse System must be ordered as back rod
- stationary pole and TBKT custom bracket must be ordered separately
- available with finials, sold separately
- rings available on front pole only

Wood fascia and finials available in any standard or custom finish
 Fascia over 16' will be spliced; blended fascia for a seamless look may be requested for an additional fee
 All traverse systems include 4 glides per foot
 All traverse systems include 2 end brackets & additional support brackets every 3-4 feet
 Single traverse systems include adjustable brackets: 3½"-4½" projection
 Double traverse systems include adjustable brackets: 2½"-3½" back and 5½"-6¼" front projection
 Custom ceiling mount brackets and larger projection traverse brackets available; sold separately
 Standard cord drop for all corded traverse systems is 120"
 All corded traverse systems may be requested as hand-drawn (uncorded)

motorized traverse systems

- Standard and Heavy Duty Systems available with plug-and-play power supply for standard wall outlets
- Single and Double Track Systems available in continuous lengths up to 20', spliced lengths up to 40'
- Center or One-Way Draw available; motors may be installed on either side of track
- Wall mount and ceiling mount options available
- Wood fascia available in all 2", 2¼" and 3" profiles and in all standard or custom finishes; continuous lengths up to 16'; splices and blended splices available
- Pinch pleat or Ripplefold®-style available: 80%, 100% and 120% fullness
- Curved track options available; curved fascia not available
- Motorized systems ship with fascia and brackets installed for easy installation



SINGLE MOTORIZED TRAVERSE SYSTEM WITH WOOD FASCIA

- standard single system brackets have a 3½" return
- 6" return brackets may be substituted at no charge
- custom ceiling mount brackets may be substituted for an additional charge
- available with finials or 3½" and 6" mitered returns, sold separately



DOUBLE MOTORIZED TRAVERSE SYSTEM WITH WOOD FASCIA

- standard double system brackets have a 6" return
- custom ceiling mount brackets may be substituted for an additional charge
- available with finials or 6" mitered returns only, sold separately

DOUBLE MOTORIZED SYSTEM WITH STATIONARY POLE ON FRONT AND TRAVERSE SYSTEM ON BACK

- to order: select Single Motorized Traverse System with or without Wood Fascia
- Single Traverse System must be ordered as back rod
- stationary pole and TBKT custom bracket must be ordered separately
- available with finials, sold separately
- rings available on front pole only

BTX DC MOTORIZED SYSTEM

- maximum drapery weight for standard motor: 60lbs
- maximum drapery weight for heavy duty motor: 120lbs
- tandem motors available for increased weight capacity
- solar motor available
- 6 channel white transmitter included
- 10' cord standard, longer lengths may be requested for an additional fee
- track, brackets, and glides available in Bronze, Gold or White
- Ripplefold®-style master carriers allow continuous rippling effect
- touch motion available on all motors
- wall switches available
- spliced lengths up to 40' standard & heavy duty

SOMFY GLYDEA™ MOTORIZED SYSTEM

- maximum drapery weight for standard motor: 77lbs
- maximum drapery weight for heavy duty motor: 132lbs
- Indoor Sun Control Accessory available
- spliced lengths up to 32' standard, 36' heavy duty
- 5 channel white transmitter included
- 10' cord standard
- track and brackets available in Bronze, Gold or white; glides available in White only
- silver motor with internal transformer
- flat overlap Ripplefold®-style master carriers
- touch motion available of heavy duty motors
- wall switches, timers, and other accessories available
- programmable "MY" position, speed control and soft start/stop features available

Wood fascia & finials available in any standard or custom finish
Fascia over 16' will be spliced; blended fascia for a seamless look may be requested for an additional fee
Custom ceiling mount brackets & larger projection traverse brackets available; sold separately
Finials sold separately

corded and motorized traverse finish reference guide

Finish Name	Finish Code	Track and Bracket Colors	Maximum Continuous Fascia Length
2013 NEW FINISHES			
Gilded Red	600	Gold	16'
Cobalt Bronze	610	Bronze	16'
Weathered Iron	620	Bronze	16'
Ash Gray	630	White	16'
Oil Rubbed Bronze	640	Bronze	16'
Hickory	650	Bronze	16'
Antique White	660	White	16'
Espresso	670	Bronze	16'
Aged Gold	680	Gold	16'
Champagne	690	Bronze	16'
Graphite	700	Bronze	16'
Tarnished Silver	710	Bronze	16'
Tawny Oak	720	Gold	16'
Rose Gold	730	Bronze	16'
Smoky Mocha	740	Bronze	16'
Polished Gold	750	Gold	16'
Rustic Iron	760	Gold	16'
Bronze Patina	770	Bronze	16'
Hazelwood	780	Bronze	16'
Vintage Bronze	790	Bronze	16'
ADDITIONAL STANDARD FINISHES			
Bronze	105	Bronze	16'
Bronze with Gold	106	Bronze	16'
Bronze with Gold and Gray	107	Bronze	16'
Flat Black	109	Bronze	16'
Flat Black with Gold	110	Bronze	16'
Silver with Gold	112	Gold	16'
Walnut Gold	117	Gold	16'
Dark Walnut Gloss with Gold	126	Bronze	16'
Antique Steel	129	Bronze	16'
Antique Steel with Black Highlights	129B	Bronze	16'
Gray with Gold	150	Gold	16'
Antique	155	Gold	16'
Walnut Gold with Gray Accents	200	Gold	16'
Walnut	240	Bronze	16'
Platinum	250	Bronze	16'
Platinum with Black Highlights	250B	Bronze	16'
Mahogany Rust	270	Bronze	16'
Pewter	320	Bronze	16'
Bronze with Black	330	Bronze	16'
Statuary Bronze with Gold	350G	Bronze	16'

Based on your specified finish we supply track and brackets that best match the finish on your fascia. Please refer to the Finish Reference Guide to the left. If you order a custom match finish, please specify your track color.

Components are included in the per foot track price, as listed in the Retail Price List. Components will match the track color when applicable (see chart at bottom of page).

Standard carriers are 4 per foot. Standard brackets are 2 end brackets with 1 support bracket for every 3-4 feet of track.

Wood pole profiles available in 2", 2 1/4" and 3" diameters can be used as fascia.

Spliced fascia will be cut at a 45° angle for an obscure splice.

Spliced fascia can be blended for an additional fee (see Retail Price List). Blended fascia will be properly connected and shipped in one continuous length.

COMPONENT COLORS

	corded		motorized	
	regular	heavy duty	BTX	Somfy
ANTIQUE GOLD			•	
BRONZE	•		•	
WHITE	•	•	•	•

C-ring carriers are available only in Bronze

additional information



PINCH PLEAT
available on all traverse systems



RIPPLEFOLD®-STYLE
available on heavy duty corded and motorized systems

BRACKETS AND PINCH PLEAT CARRIERS

quantity per system

	6'	7'	8'	9'	10'	11'	12'	13'	14'	15'	16'
pinch pleat carriers	24	28	32	36	40	44	48	52	56	60	64
brackets	3	3	4	4	4	5	5	5	6	6	6

standard carriers are 4 per foot
standard brackets are 1 every 3-4 feet



HDTB35
steel traverse bracket, single adjustable 3½" - 4½" return 2¾"H x 1½"W backplate
must specify which traverse system to be used with to ensure proper fit



HDTB
steel traverse bracket, single or double adjustable 5½"-6¼" front return adjustable 2½"-3½" back return 3⅝"H x 1½"W backplate
must specify which traverse system to be used with to ensure proper fit



regular corded traverse ceiling mount bracket clip, single
¼"H x 2½"Deep, ⅞"W
for track-only system without fascia



ball bearing corded traverse ceiling mount bracket clip, single
⅝"H x 2⅝"Deep, ⅞"W
for track-only system without fascia

traverse fascia L-bracket
½"H x 1⅝"Deep, ¾"W
combines with ceiling mount bracket clip to attach fascia to ball bearing corded traverse and motorized traverse systems

(fascia is screwed directly onto front of regular corded traverse system track; no fascia L-bracket/bracket clip needed to attach regular corded traverse fascia)

BTX ceiling mount bracket clip, single
⅝"H x 2¼"Deep, 1⅝"W
Gold, Bronze or White
for track-only system without fascia

Somfy ceiling mount bracket clip, single
⅝"H x 2"Deep, 1"W
Gold, Bronze or White
for track-only system without fascia

all ceiling mount bracket clips can also be used to attach fascia L-bracket to track

For double ceiling mount installation, install two individual bracket clips into ceiling



CMTB
steel custom ceiling bracket, single or double 2¾"H x 1½"W backplate
specify drop: contingent upon whether C-rings are used and which finials are chosen



225CR
wood traverse C-ring 2½"ID, 4¼"OD
use with 2" or 2¼"D wood fascia

3CR
wood traverse C-ring 3¾"ID, 5"OD
use with 3"D wood fascia



wood and resin
display board 1
42"H x 24"W x 7"Deep
wall mount



wood and resin
display board 2
42"H x 24"W x 7"Deep
wall mount



steel
display board
42"H x 24"W x 7"Deep
wall mount



the modern collection
display unit 1
3"H x 24"W x 4"Deep
wall mount



the modern collection
display unit 2
3"H x 24"W x 4"Deep
wall mount

PRICING AND TERMS

Prices found in The Finial Company Price List are our Suggested Retail Prices. Prices are subject to change without notice. Prices are quoted exclusive of Freight and Packaging. The Buyer should always inspect the product upon receipt.

IMPORTANT: Please note that your order will be placed with an authorized Finial Company Distributor. While most of the following will generally apply, your distributor may have terms and conditions of the sale that will vary from what is stated here.

RUSH ORDERS: Rush orders are available. An additional 30% charge applies to product and all fees excluding Freight and Packaging. Rush orders will ship within 5 business days. The 30% rush charge is available for all product except arch rods, bay windows, custom brackets, and mitered returns. If an order is received after 12:00 C.S.T., the next business day will count as the first day of production.

IMPORTANT: Please note that rush orders are not always available due to the nature of scheduling in a strictly custom manufacturing environment. Processing time for a rush order is in Business Days, (excluding holidays) not calendar days.

SHIPPING: All hardware orders are shipped FOB Dallas, Texas. Poles over 96" MUST be shipped by common carrier. Please see The Finial Company Retail Price List for applicable Freight and Packaging fees.

RETURNS, CHANGES & CANCELLATIONS

All orders are considered "CUSTOM". No changes or cancellations will be accepted on orders that have begun production. All returns must be authorized by The Finial Company customer service department, and are authorized at our discretion, given the circumstances and nature of each custom order.

Restocking fees of 40% apply and the customer prepays freight. A Return Authorization Number (RA#) must be issued by customer service and the RA# must be noted on all return packages. Return Credit is issued on returned goods that are inspected and deemed undamaged. Customers should exercise care to adequately package return goods. Return Credit will not be issued for unauthorized returns or damaged returns.

DAMAGED GOODS

Immediately upon receipt, your order should be inspected to insure that there is no concealed damage from shipping. Claims on damaged merchandise must be made within 15 days of receipt. No claims after 15 days will be accepted. If your order is damaged in shipping, carriers require that ALL packing materials be kept in order for a representative to inspect the goods. Our policy is that we replace damaged product per the original order.

Please note on the Bill of Lading if there is any possibility of concealed damaged.

PRODUCT INFORMATION

WOOD POLES AND TRAVERSING RODS: Wood poles and traversing rods are sold in 2 foot increments, 2 foot minimum. We will cut your pole to specification, but we do not save or ship the fall off.

STEEL POLES: All steel poles are sold in 1 foot increments, 2 foot minimum. We will cut to your specification, but we do not save or ship the fall off.

SUPPORT BRACKETS: We recommend support brackets every 3–4 feet.

INSTALLATION: Mollie bolts and nail anchors are recommended for all installations, but are not included. We strongly recommend using a professional installer for our hardware.

FORCE MAJEURE: The Finial Company is not liable for any performance failure that arises from any cause not within its control.

ITEM	PAGE	ITEM	PAGE	ITEM	PAGE
384	43	3CSB2	62	AC138	77
385	43	3EB4	62	AC200	77
386	43	3EC	60	AF100-1	76
387	43	3FRB	63	AF200-1	76
407	43	3GR	61	AF300-1	76
3148	60	3L1	62	AF400-1	76
4519C	23,29,79	3L2	62	AF500-1	76
45834	16,22	3L3	62	AF600-1	76
125ELB	15,21,27,33	3L4	62	ARBC	12
1330HBL	36	3L5	62	ARBE	12
1340HB	36	3L6	62	B1756	38,44,80
138EC	43	3LELB	61	B17535	38,44,80
138TW	45	3LFB1	63	BIRD	19,25
14R704	29	3LFB2	63	BKT050-1	15
1SQ	27	3MC11	59	BKT050-2	15
2EC	53	3R9	58	BKT050-3	15
2TR	56	3R35	59	BKT075-100	20,26
2WG	56	3RD	61	BKT112-134	38
2WR	56	3RF10	58	BKT118-138	26,32,44
225-CR	85	3RF20	59	BKT200-214	54
225EC	53	3RF86	58	BL25	68
225FL	56	3RY10	59	BL35	68
225LGFT	50	3SF17	28,34	BL4	6,20,26,32,38,44,54,62
225MC5	57	3SM	61	BL6	68
225MC6	49	3TR	61	BRANCH W LEAF	19,25
225MC9	50	3W9	60	C1	72
225MC10	51	3W75	60	C2	72
225MC11	48	3W100	59	C3	72
225MC13	49	3W200	59	C4	72
225MC15	48	3W513	60	C6	72
225RF86	50	3WB1	62	C7	72
225RF90	49	3WB2	62	C8	72
225RWR	56	3WF10	60	CRSR3	7,26
225TR	56	3WY10	60	CRSR7	7,33
225WB1	54	38B	44	CRSR12	7,39
225WB2	54	38EB3	44	CS1756	38,44
225WCS1	54	38EB5	44	CS17535	38,44
225WCS2	54	38EC	43	CSB1	54
225WF90	53	38FLR	45	CSB2	54
225WG	56	38ISM	44	CSL16	20,26,32
225WR	56	50SRB	15	CSL125	20,26,32
225WS	56	75HSRB	21,80	CSL135	20,26,32
225WWR	56	75RD	21	CSWB1	54
3-CR	85	A1756	38,44	CSWB2	54
3CSB1	62	A17535	38,44	DB76	55

ITEM	PAGE	ITEM	PAGE	ITEM	PAGE
DB77	63	F138-5C	42	IMB050-1	15
DB78	55	F138-5S	42	ISM	54
DB79	63	F138-6	43	K657	17,22,28
DB80	55	F138-7	42	L125	20,26,32
DB91	55	F138-8	42	L125100	20,26,32
DB92	55	F138-9	42	L125SQ	20,26
DB93	63	F214-1	46	L135	20,26,32
DB94	63	F214-2	46	L135100	20,26,32
DBL1	6,20,26,32,38,44,54,62	F214-3	46	L135SQ	20,26
DRRG3	39,56	F214-4	46	L16	20,26,32
DRRG4	61	F214-5	47	L26	20,26,32,80
EB1	20	F214-6	47	L235	20,26,32,80
EB2	20	F214-7	46	L651	16,23
EB3	26,32,80	F214-8	46	L651+FC1	35
EB4	26,32,80	F214-9	46	L848	18,23,79
EB5	38,44,80	F214-10	46	L848+FC1	35,79
EB6	38,44,80	F214-11	46	L885875	17,23
EB7	54	F214-12	46	L9328	23,28
EB8	54	F214-13	47	L9328B	23
EB24	54	F214-14	47	LARGE SWING ARM	7
EB26	54	F214-15C	47	LELB	56
EB2254	54	F214-15S	47	LF225	49
EB2256	54	F214-16C	47	LFB3	55
EC1	22,28,65	F214-16S	47	LFB4	55
EC2	22,28,64	F300-1	58	LL	6
EC3	34,65	F300-2	58	LS385	29,35,79
EC4	14,16,64	F300-3	58	LS385+FC1	35
EC135	22,28,79	F300-4C	58	MB100	27,69
EC214-1	46	F300-4S	58	MB138	45,69
EC300-1	58	F513	59	MB214	56,69
EP1	50	FBKT	6,20,26,32,38,44,54,62	ML100-B	77
EP7	51	FBTN	21,27,33,39,45,56,61	ML100-BN	77
EP8	51	FC1	34	ML100-CH	77
EPBTN1	45,56,61	FSR1	27,33,45	ML100-GM	77
EPBTN2	45,56,61	FSR2	39	ML138-B	77
FO50-1C	14	GB1	48	ML138-BN	77
FO50-1S	14	GB2	47	ML138-GM	77
FO50-2C	14	GB3	51	NBL2	68,80
FO50-2S	14	GB4	43	NBL4	68,80
FO50-3	14	HSR1	33,45,80	NBL6	68,80
F138-1	42	HSR175	39,80	OVL1	27,33,45,80
F138-2	42	HSR2	56	OVL2	52
F138-3	42	HSR3	61	OVL3	21,27,33,45
F138-4C	42	IM125	20,26,32,80	OVL7	39,56
F138-4S	42	IM175	38,44,80	OVL12	56

ITEM	PAGE	ITEM	PAGE	ITEM	PAGE
OVL175	39,80	RF20	52	SF21	18,24,30
PB	19,25	RF21	52	SF22	18,23,29,37
PBN	19,25	RF22	51	SF35	14
R1	66	RF63	48	SF36	16
R2	66	RF63R	64	SF37	14
R5	66	RF64	51	SF38	14
R8	67	RF65	52	SF45	23,29
R10	67	RF86	43	SF50	365
R11	65	RF92	50	SF59	24,30
R15	64	RF1000	47	SF63	28,34,79
R16	64,79	RFVB	48	SF66	18,24,29
R17	66	RMC1	65	SF69	16,22
R18	64	RMC11	67	SF70	29,35
R21	65	RMC13	65	SF90	34
R22	64	RMC14	65	SF92	30,37
R23	64	ROS1C	64	SF96	31,37
R24	65	ROS1S	64	SF98	23,29
R56	64	ROS2	65	SF100	35
R57	65	ROS3	67	SF131	28
R64	65	ROS4	66	SF132	24,29
R65	65	ROS5	67	SF133	16,22,28
R67	65	ROS6C	66	SF134	34
R73	66	ROS6S	66	SF135	17,22
R101	66,79	RR100	27,80	SF137	36
R102	65,79	RR125	33,80	SF138	29,34
R103	67	RR175	39,80	SF140	36
R104	67	RRND	64	SF141	31,37
R105	64	RTB18	71	SF150	34
R107	67	S93	14,16	SF151	34,79
R369	58	SBTN	15,21,27,33,45,39,56,61	SF152	36
R2400	48	SCB35	7,26,32,38	SF158B7	17,23,29
R22569	48	SCB6	7,26,32,38	SF180	16,23
R22575	48	SCBC	7	SF192	34
RD3	59	SCBCDBL	7	SF201	17,22
RD125	33	SEC2	28,34,65,79	SF202A	16,22
RD175	39	SEC125	16,22,28,64,79	SF202B	16,22
RD225	52	SELB	39,45	SF205	18,24,30
RDSY2	64	SF1	16,23	SF216	18,24,29
RDSY4	67,79	SF3	16	SF218	36
REC73	46,64	SF4	28,34	SF222	23,29,79
REP1	66	SF8	36	SF228	36
RF3	43	SF14+FC1	37	SF230	22,28
RF4	28,65	SF17	34	SF235	35
RF5	42	SF19	18,24,30	SF236	17,22
RF10	48	SF20	30,36	SF237	22,28

ITEM	PAGE	ITEM	PAGE	ITEM	PAGE
SF238	30,35	SR3	27,33,80	WS38	45
SG100-1	76	SR5	39,56,80	WTBS2	68
SG110-1	76	SR7	39,56,80	WTBS4	68
SG120-1	76	SR11	61	WTBS6	68
SG120-1.375	77	SR12	56	WW2	52
SG130-1	76	SR13	45	WW3	49
SG130-1.375	77	SRH75	21	WW4	49
SG140-1	76	SRT1	27	WW9	57
SG140-1.375	77	SRT2	33	WW10	50
SG150-1	76	SSA	28	WW11	50
SG150-1.375	77	ST2	27,80	WW19	49
SG160-1	76	ST3	27,80	WW21	50
SG170-1	76	STB	70	WW23	51
SG180-1	76	STBA1	71	WW24	49
SG300-1	77	STBA3	70	WW26	58
SG300-1.375	77	STBA5	70	WW29	48
SG310-1	77	STBA7	70	WW34	51
SG310-1.375	77	STBA8	70	WW35	50
SG350-1	77	STBA21	70,80	WW47	49
SG350-1.375	77	TB19	71	WW51	47
SG360-1	77	TBA	71	WW60	49
SG360-1.375	77	TBKT	6,20,26,32,38,44,54,62	WW70	50
SG370-1	77	TRT	39	WW75	59
SG370-1.375	77	TTBH1	70,80	WW77	53
SG380-1	77	TTBH2	70,80	WW79	53
SG380-1.375	77	TWCH	39	WW90	53
SG400-1	77	TWCH125	33	WW91	53
SG400-1.375	77	W551	53	WW110	51
SG500	77	W2400	53	WW190	43
SG510	77	WBTN	27,33,39,45,56,61	WW200	47
SG510-1	77	WD60	53,68	WW201	48
SG520	77	WF10	53	WW203	50
SG520-1	77	WG38	45	WW205	49
SGELB-1	77	WL1	54	WW206	52
SGELB-1.375	77	WL2	54	WW207	49
SGSPICE-1	77	WL3	54	WW251	51
SGSPICE-1.375	77	WL4	54	WWB1	54
SHT1	27	WL5	54	WWB2	54
SL	6	WNF38	45	WWB3	44
SL3	6,18,30	WR2	68	WWF	56
SMALL SWING ARM	7	WR30	68	WWR	56
SQEC	22	WR38	45	WWRG	39,56
SQRG1	21,27	WR40	68	WY10	53
SR05	15	WR50	68	Y10	48
SR1	21,80	WRG3	61	Y2K	50

special collection finishes

essential sets *all 1" and 2" Essential Sets are available in 5 finishes*



105 Bronze



110 Flat Black with Gold



117 Walnut Gold



126 Dark Walnut Gloss with Gold



250 Platinum

the modern collection *Chrome is available for Artforms by design² finials only*



Brushed Nickel

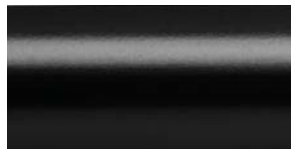

Black



Gunmetal



Chrome

outdoor hardware collection *all Outdoor Hardware finishes have a high gloss protective topcoat*



105-OH Bronze

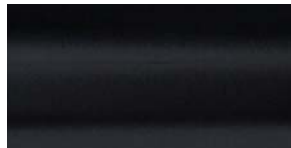

109-OH Flat Black



440-OH Soft Gold



270-OH Mahogany Rust



450-OH Aluminum

2009 finishes

We will continue to paint all 2009 finishes upon request at no additional charge. The finishes on our sample chips gradually change appearance over time, specifically if they have been frequently handled. To ensure an exact finish match, you may request a strike-off for an additional charge. Customer approval of the strike-off sample is required before production will begin. The strike-off process may be skipped, with the understanding that The Finial Company will not be responsible for an exact match to the 2009 finish sample chip.

2009 finishes no longer included in our standard finishes:

101	Antique Burgundy	300	Tudor Rose
102	Antique Venetian	310	Tudor with Ivy
103	Satin Black	340	White - Flat
104	Satin Black with Gold	340G	White - Gloss
111	Gold	350	Statuary Bronze
113	Spring Green with Gold	405	Whitewash
114	Tudor	410	Weathered White
116	Weathered Gold	415	Coastal Copper
127	Black with Heavy Gold	420	Copper Verde
128	Oxblood Gold	425	Driftwood
133	Antique Brass	430	Verdigris
220	Golden Pecan	435	Silver Patina
230	Red Oak	440	Soft Gold
270G	Mahogany Rust w/Gold Accents	445	Brushed Silver
290	Black Cherry	450	Aluminum



our standard finishes

We offer a comprehensive range of sophisticated finishes to satisfy your needs and preferences...

We are proud to introduce 20 new finishes, including new bronzes, golds and wood tones. Our sample chip design shows both smooth and detailed surfaces, indicating how the finish will look on your selected product.

- ◀ For your convenience, you can unfold this cover to view all of our standard finishes as you browse our product catalog.

our process

Customization has been our custom since we began...

All products are hand painted after we receive your order. The entire order is painted together to ensure a consistent finish. The nature of hand finishing causes some acceptable variation in finish, as each order is truly one-of-a-kind.

- ◀ For more details on Special Finishes, please see the inside back cover.

special finishes

custom finishes and custom color match

Beyond our standard finishes, we can match any finish, fabric swatch, wood trim or paint color specified from your favorite paint company. A finish sample or paint color, sheen level and manufacturer must be provided by the customer. The Finial Company will then provide a strike-off sample to the customer on any wood or steel pole profile as requested. Customer approval of the strike-off sample is required before production will begin.

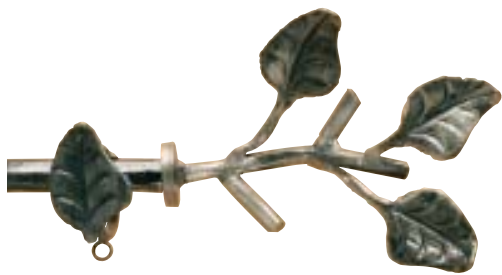

polished steel finish

Many, but not all, of our raw steel products can be polished and given a clear topcoat to achieve a finished look. Steel is not uniform in color tone and will vary in shades of gray and silver. Polishing raw steel parts requires considerably more preparation work than our other finishes and therefore incurs additional charges. Steel items that cannot be polished are listed in The Finial Company Retail Price List.

adding clear topcoat

For an additional charge, we can add a clear topcoat to any finish to achieve your preferred sheen level.



touch-up paint

Touch-up paint can be sent to the customer on request, for an additional charge.



stains

A wood stain may be specified for any of our wood products. A finish sample or stain color and manufacturer must be provided by the customer. The Finial Company will then provide a strike-off sample to the customer. Customer approval of the strike-off sample is required before production will begin.

Wood products are noted in our catalog. Wood naturally absorbs stain. The grain of the wood will absorb stain unevenly across the surface of the item. Finials, rings, brackets, and poles each absorb stain differently, resulting in a set of hardware containing color variation driven by the wood grain of each piece. This variation is part of the inherent beauty of stained wood.



painting fees

We will repaint hardware from The Finial Company or another manufacturer at the customer's request. We will also paint unfinished hardware from any manufacturer.

Please refer to The Finial Company Retail Price List for more details and a list of applicable charges.

standard finishes

are available on all The Finial Company products



105 Bronze



150 Gray with Gold



600 Gilded Red



700 Graphite



106 Bronze with Gold



155 Antique



610 Cobalt Bronze



710 Tarnished Silver



107 Bronze with Gold and Gray



200 Walnut Gold with Gray Accents



620 Weathered Iron



720 Tawny Oak



109 Flat Black



240 Walnut



630 Ash Gray



730 Rose Gold



110 Flat Black with Gold



250 Platinum



640 Oil Rubbed Bronze



740 Smoky Mocha



112 Silver with Gold



250B Platinum w/Black Highlights



650 Hickory



750 Polished Gold



117 Walnut Gold



270 Mahogany Rust



660 Antique White



760 Rustic Iron



126 Dark Walnut Gloss with Gold



320 Pewter



670 Espresso



770 Bronze Patina



129 Antique Steel



330 Bronze with Black



680 Aged Gold



780 Hazelwood

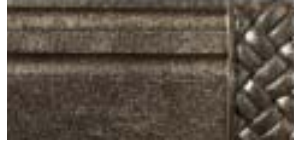

129B Antique Steel w/Black Highlights

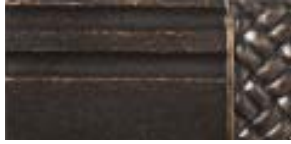

350G Statuary Bronze with Gold



690 Champagne



790 Vintage Bronze

Photographs may not accurately represent the true color of a finish. A finish may show slight variation when painted on different materials, such as wood or steel. For best possible finish match, please refer to the actual sample chip.

